



Plan and track projects

Tekla Structures 2026

March 2026

©2026 Trimble Inc. and affiliates



Contents

1	Organizer.....	7
1.1	View object properties in Organizer.....	8
	View the objects selected in the model or the objects of a category.....	9
	Set the limit for the number of objects shown in Object Browser.....	9
	View another property template.....	10
	Set the default property template.....	10
	Pin the current template in Object Browser.....	11
	Group object properties.....	11
	Show assembly content.....	11
	Combine identical rows.....	12
	Show calculated results of object property values in the sum row.....	12
	Use colors to visualize Object Browser groups in the model	13
	View categories, and unions and intersections of categories.....	13
	List the categories of objects.....	14
	Hold the current view in Object Browser and remove objects and categories from the view.....	14
	Select the command buttons shown in Object Browser.....	15
	Change the order of columns.....	15
	Change the sorting direction.....	15
	Group object properties in Organizer.....	16
	Calculate property values in Organizer.....	18
	Set the units in Organizer.....	19
1.2	Report object property values from Organizer.....	20
1.3	Create a property template in Organizer.....	24
	Create a custom property in Organizer.....	28
	Create a custom formula in Organizer.....	30
	Create a color set in Organizer.....	32
	Delete a property template in Organizer.....	33
1.4	Import a property template to Organizer.....	33
1.5	Export a property template from Organizer.....	34
1.6	Categories in Organizer.....	35
	Create location categories in Organizer.....	37
	Create location categories manually in Organizer.....	42
	Create a property category in Organizer.....	43
	Create a custom category in Organizer.....	48
	Create automated subcategories in Organizer	50
	Modify a category in Organizer.....	52
	Delete a category in Organizer.....	57
	Customized default setup for Organizer.....	57
	Excluding object types from Organizer.....	59
1.7	Synchronize Organizer with the model.....	60
	Synchronize Organizer.....	60
	Update the whole Organizer database.....	61
	Reload Object Browser.....	62

	Synchronize a category.....	62
1.8	Report Organizer location categories.....	63
1.9	Export a category from Organizer.....	64
1.10	Import a category to Organizer.....	66
	Categories created in earlier Tekla Structures versions.....	67
1.11	Import IFC categories to Organizer.....	68
1.12	Organizer in the multi-user mode.....	68
1.13	Example: Organize the model into location and custom categories, and view quantities.....	69
	Example: Organize the model to buildings, sections and floors.....	69
	Example: Create a custom category with automated subcategories based on object names in Organizer.....	73
	Example: Create a custom category for reinforcing bars in Organizer.....	75
	Example: Create a concrete quantity take-off using Organizer.....	76
	Example: Create a reinforcing bar quantity take-off using Organizer.....	79
1.14	Example: Track modeling and planning issues using Organizer.....	81
	Example: Track reinforcing bar length using Organizer.....	81
	Example: Track too heavy precast elements from a reference model using Organizer.....	85
	Example: Create weight group categories to track different weights using Organizer.....	86
	Example: Track large concrete volumes using Organizer.....	87
1.15	Example: Report areas based on object groups in Organizer.....	89
1.16	Example: Calculate and report areas based on object type and project status in Organizer.....	96
1.17	Example: Add a classification code to objects in Organizer and export the code to IFC.....	111
1.18	Example: Create a custom category for structural design status in Organizer.....	117
1.19	Example: Create a custom category for architectural design status in Organizer.....	118
1.20	Example: Organizer for steel - manage bolts.....	121
1.21	Example: Organizer for steel - manage assemblies.....	123
1.22	Example: Organizer for precast.....	124
2	Building hierarchy.....	128
2.1	Building hierarchy elements.....	129
2.2	Create a building hierarchy in the model.....	130
2.3	Import a building hierarchy from a reference model.....	131
2.4	Modify the properties of building hierarchy elements.....	132
2.5	Assign objects to building hierarchy elements.....	134
2.6	View and filter building hierarchy elements.....	136
2.7	Create views on selected building storeys.....	137
2.8	Example: Building hierarchy in Organizer.....	137
3	Task Manager	139

3.1	Task manager user interface.....	140
	Modify your Task manager view.....	140
	Modify the calendar in Task manager.....	142
3.2	Create a task in Task manager.....	143
	Link a task to the model.....	144
	Define a task type.....	146
	Define a contractor in Task manager.....	147
	Define general task properties.....	147
	Define a task schedule.....	148
	Manage the planned dates of objects in a task.....	149
	Track a task schedule.....	150
	Define the order of objects in a task.....	151
	Define a dependency between tasks.....	153
	Define additional information for a task.....	154
	Create a scenario.....	154
3.3	View and filter tasks in Task manager.....	155
3.4	Import and export tasks and task types in Task manager.....	158
	Import tasks and task types.....	158
	Export tasks and task types.....	160
3.5	Print a task schedule from Task manager.....	160
3.6	Example: Visualize a Task manager schedule in the model.....	161
4	Phase Manager.....	164
4.1	Divide the model into phases.....	164
4.2	Lock and unlock objects in specific phases.....	165
4.3	Define custom phase properties.....	166
5	Lotting.....	167
5.1	Create a lot.....	167
5.2	Add parts to a lot.....	168
5.3	Remove parts from a lot.....	168
5.4	Delete a lot.....	169
6	Sequencer.....	170
6.1	Create a sequence.....	170
6.2	Add parts to a sequence.....	171
6.3	Check the sequence of a part.....	171
6.4	Modify the sequence number of a part.....	172
6.5	Delete a sequence.....	172
7	Project status visualization.....	173
7.1	Create a visualization.....	173
7.2	Copy visualization settings to another model.....	174
7.3	Delete visualization settings.....	174
7.4	Project status visualization example: Visualize the erection schedule of a project.....	174

8	Reports.....	181
8.1	Create a report.....	182
	Create a report of entire model or selected objects.....	183
	Create a report of selected drawings.....	184
	Create a report of nested assemblies.....	184
	Report settings.....	185
8.2	Prepare and create Excel (XLSX) reports.....	186
	Prepare Excel template (.xltx).....	187
	Prepare textual template (.xlsx.rpt).....	188
	Export Excel report.....	188
	Examples.....	191
8.3	Create multiple reports using Multireport generator.....	192
	Create multiple reports.....	192
	Modify template search filters.....	195
8.4	Show an existing report	196
8.5	Print a report	197
8.6	Tips for reports and report templates.....	200
	Select objects to include in a report using GUIDs.....	200
	Show report content in correct cells.....	201
	Add cell separator in Excel reports.....	203
9	Disclaimer.....	204

1 Organizer

Organizer is a daily tool for managing model information, object property queries, and object classification. Using **Organizer**, you can access all model information, including IFC information, in one place, and manage your model information effectively. **Organizer** is an efficient tool at any stage in the construction and design process for designers, detailers, managers, estimators, contractors, or anybody using the model information.

For example, construction managers can view and report on key properties of parts and groups of parts of the Tekla Structures model, such as the quantities of purchasing packages. Designers can instantly check object, assembly, cast unit, or pour unit properties during design to ensure that the properties are as they are intended to be. For example, by creating categories it is easy to automatically track precast or steel elements that are too heavy, reinforcing bars that are too long, and status info.

You can synchronize **Organizer** with the model to get instant feedback on what is changing in the model and create reports on demand.

Organizer consists of two tools:

- Use **Object Browser** to instantly view and create reports on model information based on the selections you make.
- Use **Categories** to define building locations to automatically arrange model objects and visualize the locations in the model. You can also create categories based on different properties and write user-defined attributes to objects based on the categories the objects belong to. You can use filters to automatically update the category content whenever there are changes in the model. You can also manually change the content of categories.

See also

[View object properties in Organizer \(page 8\)](#)

[Report object property values from Organizer \(page 20\)](#)

[Create a property template in Organizer \(page 24\)](#)

[Create a color set in Organizer \(page 32\)](#)

[Import a property template to Organizer \(page 33\)](#)

[Export a property template from Organizer \(page 34\)](#)
[Categories in Organizer \(page 35\)](#)
[Synchronize Organizer with the model \(page 60\)](#)
[Export a category from Organizer \(page 64\)](#)
[Import a category to Organizer \(page 66\)](#)
[Import IFC categories to Organizer \(page 68\)](#)
[Organizer in the multi-user mode \(page 68\)](#)
[Example: Organize the model into location and custom categories, and view quantities \(page 69\)](#)
[Example: Track modeling and planning issues using Organizer \(page 81\)](#)
[Example: Add a classification code to objects in Organizer and export the code to IFC \(page 111\)](#)
[Example: Create a custom category for structural design status in Organizer \(page 117\)](#)
[Example: Create a custom category for architectural design status in Organizer \(page 118\)](#)
[Example: Organizer for steel - manage bolts \(page 121\)](#)
[Example: Organizer for steel - manage assemblies \(page 123\)](#)
[Example: Organizer for precast \(page 124\)](#)

1.1 View object properties in Organizer

You can view the properties of selected model objects in **Object Browser**. **Object Browser** lists the objects that you have selected in the model or the objects of the categories you have selected. The object properties are shown in columns. You can change the order and sorting direction of the columns, and group the properties to view the object data in a structured way.

Click **Reload the view**  in **Object Browser** when you want to view the latest property values from the model. Once you have viewed a property of any object, the property will be updated in the **Organizer** database at synchronization.

NOTE Synchronizing **Organizer**  updates all properties of the changed objects in the **Organizer** database. You do not need to reload **Object Browser** if you change the selection in the model, or select another category or another property template. When you have synchronized **Organizer**, the object properties are up to date until you make changes in the model.

You can use Tekla Structures selection switches to select the needed objects in the model, select assemblies , for example.



To view object properties in **Organizer**:

1. To open **Organizer**, click **Manage** on the ribbon and then click **Organizer**.
2. Select model objects in the model, or a category in **Categories**.
3. Reload  **Object Browser** to show the latest object property values.

View the objects selected in the model or the objects of a category

On the **Object Browser** toolbar, the automatic selection  is selected by default. **Object Browser** automatically shows objects either from the model or from the categories. If you have a category selected, **Object Browser** only shows the objects that are in the category. If you have selected objects in the model, **Object Browser** only shows these objects.

You can switch off the automatic selection if you want to control whether objects are shown from the model or from the categories:

1. Click  to activate the other selection buttons.
2. Select the option you want to use:
 - Click  to show objects from the model.
 - Click  to show objects from the categories.

Note that the objects of a selected category are by default not highlighted or selected in the model.



To view the objects of a selected category in the model, select either **Select objects in the model** or **Highlight objects in the model** from the list at the bottom of the categories.

Set the limit for the number of objects shown in Object Browser

Object Browser may not automatically show the objects you selected in the model or in a category. There is a predefined limit for the number of objects shown in **Object Browser**. If the number of objects you have selected is above

the limit, **Object Browser** shows you how many objects you have selected and what the limit for showing the objects is.

Do any of the following:

- Click  to show the objects.
Object Browser shows the objects and the object properties stored in the **Organizer** database.
- Click  to reload the object properties and to show the objects.
Object Browser shows the objects and the object properties that have been updated in the model.
- Change the predefined limit by entering a number in the box, for example . Then click .
The number you enter in the box becomes the default limit for showing objects in **Object Browser**.
- Make another selection.

You can also set the limit in **Organizer Settings**. Click  in the upper-right corner of **Organizer** and go to the **Synchronization** tab.

View another property template

Select another template from the template list to view the same object selection with a different template.

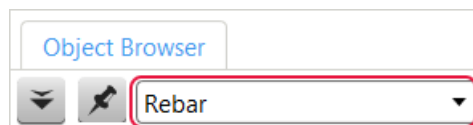

Set the default property template

1. Click  in the upper-right corner of **Organizer** to open the **Settings**.
2. Select a template from the property template list and click **Set as default**.

3. Click **Modify** to save your selection.

The **Set as default** button is hidden when you have the default template open. When you select another template, the button is shown again.

Pin the current template in Object Browser

Pinning a template holds the selected template visible in **Object Browser**.





When you pin a template and select different categories to view the model objects in **Object Browser**, the pinned template is shown even if the selected category has another template defined for it. This is useful if you want to compare different categories using a certain template.

1. Click  to pin the current template in **Object Browser**.

You can still select another template from the template list. Pinning always keeps the latest selected template visible.

Click  to release the template.

Group object properties



1. Click  and select **Group** .
- Object Browser** displays a grouping row.
2. Select a property column heading and drag the column to the grouping row.
3. Click  and select **Group**  to hide the grouping row.

For more information, see [Group object properties in Organizer \(page 15\)](#).

Show assembly content

1. Click  and select **Show content**  to show the objects in the assemblies, cast units, or pour units that are currently listed in **Object Browser**.





The assembly, cast unit, or pour unit hierarchy levels are shown in different shades of blue.

2. Click  and select **Show content**  to hide the assembly content.
The assembly, cast unit, and pour unit hierarchy levels are also removed when you sort and group objects in **Object Browser**. The objects shown in **Object Browser** remain the same.

Combine identical rows

You can combine the rows that have the same property values in the **Object Browser** view. When you combine the rows, **Object Browser** displays a **Count** column that shows how many rows have been combined.

You can also select whether to show a single property value or the sum of the property values in a column. The sum of the values is the single value multiplied by the number of combined rows.

1. Click  and select **Combine identical rows** .
- Combined rows are shown even if you select another category in **Categories**.
2. If needed, click **Modify** to include the combined rows in the property template.
3. To show the sum of the property values in a column, click  in the upper-right corner of **Organizer** to open the **Settings**, locate the property under **Columns** and set the **In combined row show** option to **Result**.
4. Click  and select  to remove the combined rows.

Show calculated results of object property values in the sum row

1. Select whether **Object Browser** calculates the results from all or selected rows.

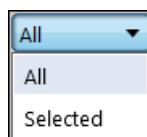



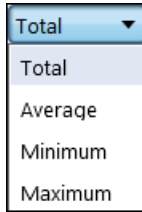

2. Select whether **Object Browser** shows the calculated total, average, minimum or maximum values.



For more information, see [Calculate property values in Organizer \(page 18\)](#).



Use colors to visualize Object Browser groups in the model



1. Click  and select **Group** .
2. Select a property column heading and drag the column to the grouping row.
3. Click  and point the **Color set** command.
Object Browser lists the color sets that are available.
4. Click the **Group** command to select the current set, or select a suitable color set from the sets that are available.
5. Click  and select a command other than **Group** to remove the colors.

Organizer assigns colors to the groups shown in **Object Browser**. The topmost group in **Object Browser** gets the first color in the color set, the next group gets the second color, and so on. The objects on the lowest group levels are shown in the model using the assigned color.

For more information, see [Create a color set in Organizer \(page 32\)](#).

View categories, and unions and intersections of categories

1. Select more than one category in the category tree.
2. Click  and select any of the following:
 -  **Automated** is the default.
Automated shows the union of the object content of categories that are under the same category root and the intersection of the object content of categories that are in different category roots.
 -  **Separate categories** shows the objects per category.
Automated adds the category structure to **Object Browser**.

-  **Union of categories**
Object Browser shows the union of the object content of the selected categories.
-  **Intersection of categories**
Object Browser shows the intersection of the object content of the selected categories.







You can also click  at the bottom of **Categories**. The selection pane shows either a union or an intersection of the selected categories, depending on what you have selected. Drag categories between the boxes to modify the unions and intersections.

When you view unions and intersections using the selection pane, ensure that the **Show the categories in Object Browser**  button is not active.

List the categories of objects

1. Select one or more rows in **Object Browser**.
2. Right-click and select **List the categories**.
The category list shows all the categories that contain at least one of the selected objects.
3. Click a category in the list to highlight the category in **Categories**.

Hold the current view in Object Browser and remove objects and categories from the view

1. Click  and select  to hold the current view.
Your new selections in the model or in the categories are added to the **Object Browser** view.
2. Remove objects and categories from the view:
 - To remove an object, right-click a row and select **Remove from the view**.
 - To remove a category, click  and select  **Separate categories**. Right-click the category and select **Remove from the view**.
3. Click  and select  to release the view.

Select the command buttons shown in Object Browser

1. Click  in the upper-right corner of **Organizer** to open the **Settings**.
2. Go to the **Toolbar** tab.
3. Select the buttons that you want to show on the **Object Browser** toolbar.

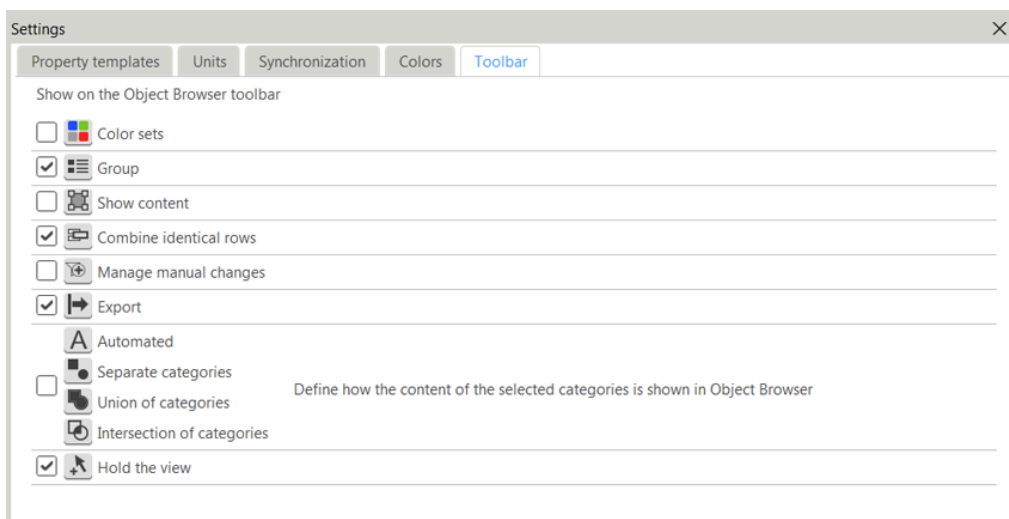

4. Close the **Settings** dialog.

Change the order of columns

Select a property column heading and drag it on the column heading row to the desired location.

Change the sorting direction

1. Click a column heading to show the sorting direction.
The default direction is ascending. You can change the default direction in the **Settings**, click  in the upper-right corner of **Organizer**.
2. Click the column heading again to change the sorting direction.

See also

[Set the units in Organizer \(page 19\)](#)

[Categories in Organizer \(page 35\)](#)

Group object properties in Organizer

You can sort the objects shown in **Object Browser** by grouping the objects based on their properties. You can group object properties both in **Object Browser** and in **Organizer Settings**. The grouping you define in **Settings** is used in a property template when you save the template.

1. To open **Organizer**, click **Manage** on the ribbon and then click **Organizer**.
2. Select objects in the model or select a category to view the objects in **Object Browser**.
3. Click  and select **Group**.
4. Drag one or more property columns to the grouping row.

The objects are grouped according to the order of properties in the grouping row, from left to right.

In the **Organizer Settings**, the grouping row is always available. To open

the **Settings**, click  in the upper-right corner of **Organizer**.

When you group object properties in the **Settings**, the grouping is simultaneously shown in **Object Browser** if the grouping row is visible.

In the example below, the first grouping level is **Name**, the second level is **Material**, and the third level is **Profile**.

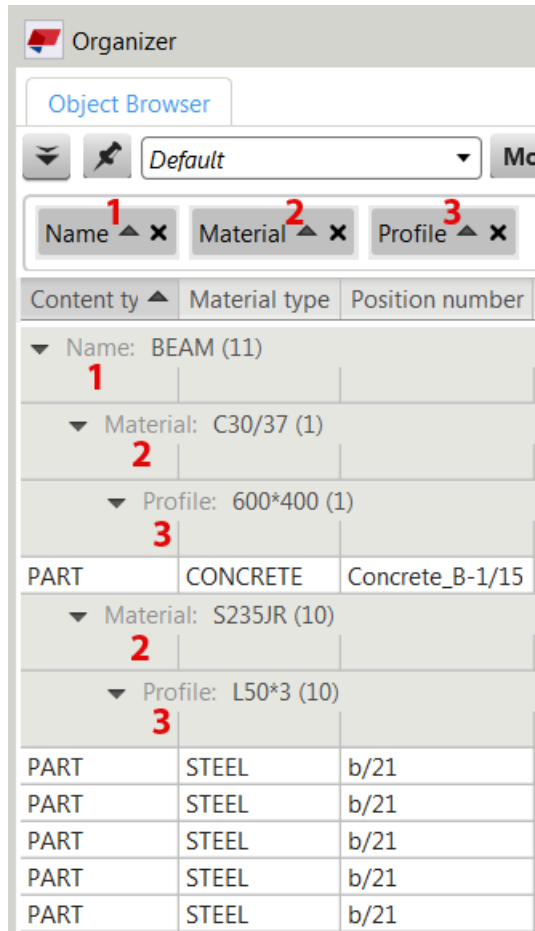

5. Do any of the following:
 - a. Drag the object properties in the grouping row to change the grouping order.
 - b. Click an object property in the grouping row to change the sorting direction.
 - c. Click **Remove grouping**  to remove an object property from the grouping row.
 You can also drag the object property back to the column headings row. When you drag the property, it is placed to the location where you drag it to.
6. Click **Modify** to include the grouping to the template.
7. To permanently save the grouping to the template, save the Tekla Structures model.

See also

[Create a property template in Organizer \(page 24\)](#)

[View object properties in Organizer \(page 8\)](#)

Calculate property values in Organizer

Object Browser shows the calculated total, average, minimum or maximum object property values in a sum row. You can select which values are shown, and whether the values are calculated from all the rows or from the rows you have selected in **Object Browser**.

Click **Reload the view**  in **Object Browser** when you want to view the latest property values from the model. Once you have viewed a property of any object, the property will be updated in the **Organizer** database at synchronization.

NOTE Synchronizing **Organizer**  updates all properties of the changed objects in the **Organizer** database. You do not need to reload **Object Browser** if you change the selection in the model, or select another category or another property template. When you have synchronized **Organizer**, the object properties are up to date until you make changes in the model.

-
1. To open **Organizer**, click **Manage** on the ribbon and then click **Organizer**.
 2. Select objects in the model or select a category to view the objects in **Object Browser**.
 3. Select whether **Object Browser** calculates the results from all or selected rows.

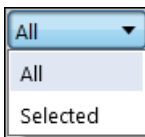

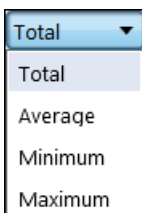

All is the default.

4. If you select **Selected**, select the rows in **Object Browser**.
5. Select a value option from the list:



The values are shown at the bottom in the sum row. The value is the rounded result of the precise object property values.

NOTE By default, **Object Browser** shows the calculated values of properties for which it is useful to calculate results. If you do not want to show the calculated

value of a property, click  in the upper-right corner of **Organizer** to open the **Settings** and set the **In sum row show** option to -. Reload  the **Object Browser** view.

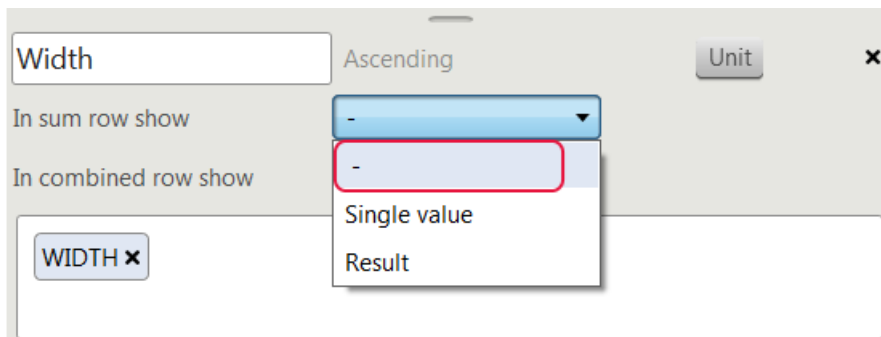

See also

[View object properties in Organizer \(page 8\)](#)

[Set the units in Organizer \(page 19\)](#)

Set the units in Organizer

The default units in Tekla Structures depend on the settings in **File --> Settings --> Options --> Units and decimals**. You can change these default settings in **Organizer** to view a different unit system, unit type, and precision in **Object Browser** and in **Categories**.

1. To open **Organizer**, click **Manage** on the ribbon and then click **Organizer**.
2. Click  in the upper-right corner of **Organizer** to open the **Settings**.
3. Go to the **Units** tab.
4. Select a unit system from the list.
5. Select a unit from the list.
6. Select a precision from the list.

Use the precision option for **Others** if you want to define the precision for quantities other than distance, area, volume, or weight.

NOTE You can set the unit of an individual property column in **Organizer Settings**

 by clicking **Unit** in the column. These individual settings override the **Units** tab settings. Individual settings are useful if you want to show the length in imperial and metric units in one template, for example.

See also

[View object properties in Organizer \(page 8\)](#)



[Calculate property values in Organizer \(page 18\)](#)

1.2 Report object property values from Organizer

You can export object property values from **Object Browser** to Microsoft Excel for further processing. The property columns in **Object Browser** are exported exactly as they are shown. You can use predefined default Excel templates, or you can create your own Excel templates for the export.

Ensure that you have Microsoft Excel installed on your computer.

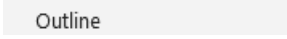
If you want to create your own templates, first create a `\ProjectOrganizerData\ExcelTemplates` folder under the current model folder, project folder, firm folder or system folder, and save the templates there. This way you can select your template from the list of available templates in the **Export data to Excel** dialog.

-
- TIP** • If you want to place the object properties to a certain location in the Excel template, modify the template by typing `%&O%` to the cell from which you want data placement to start, and save the template.
- You can also define in the Excel template how the summary rows are shown: either above or below the object rows. Go to the **Data** tab in the Excel template, click the small arrow in the **Outline** area  `Outline` , select the needed setting, and click **OK**. Then save the template.

-
1. To open **Organizer**, click **Manage** on the ribbon and then click **Organizer**.
 2. Select objects either in the model or in the categories to view the objects and their properties in **Object Browser**.
 3. Select a suitable property template.
 4. Click  and select **Export**.
 5. Select an Excel template from the list of available templates, or click **Browse** to select another template.

If you do not select a template, a default Excel template is used in the export.

Object Browser lists all the Excel templates that are available for the export in the following folders:

- Current model folder
- Project folder (`XS_PROJECT`)

- Firm folder (XS_FIRM)
 - System folder (XS_SYSTEM)
6. Select one or more export options:
- **Update object properties from the model** is selected by default.
The latest object properties from the model are updated to **Object Browser** for the export.
 - **Export without column headers**
Select whether to export without the **Object Browser** column header line.

This option is useful if you have predefined column headings in the Excel template.
 - **Export only summary rows**
Select whether to only export **Object Browser** summary rows.
7. Click **Export**.
- Microsoft Excel opens automatically. Grouping, combined rows, and calculated values (total, average, minimum and maximum) are also exported.

Example: Export project properties

You can automatically include any project property to the object property export. You can do this by creating a separate property template for the project properties and naming it as `W_Project_data`.

NOTE You must use `W_Project_data` as the name of this template.

1. Define the project properties in **File --> Project properties** . In this example, you enter the project name, project builder, and a project comment in the user-defined attributes.

Project properties

General

Project number

Name

Builder

Object

Designer

Location

Address

Postal box

City

Region

Postal code

Country

Start date 14

End date 14

Info 1

Info 2

Description (0/78)

Modify

GUID: 3dbc0285-88fe-4019-924a-660a390403d7

Base points

Location by

Base points

Attributes

User-defined attributes

- In **Organizer**, [create a property template \(page 24\)](#) for the project properties you defined above. In this example, you only add the project properties to the template.

You can add any properties in the template. Note however that **Organizer** will add to the report the first random value that it finds for the property. Therefore, add in the template only such properties that have the same value for all objects. For example, you can add `PHASE` to the template if all

the objects you intend to include in the report are going to belong to the same phase.

- a. Click  in the upper-right corner of **Organizer** to open the **Settings** and click **Template**.
- b. Name the template as `W_Project_data` and select **Blank template**.
- c. Click **Create**.
- d. Drag the `PROJECT.NAME`, `PROJECT.BUILDER` and `PROJECT.USERDEFINED.PROJECT_COMMENT` project properties to the property columns.
- e. Click **Modify** to save the template.

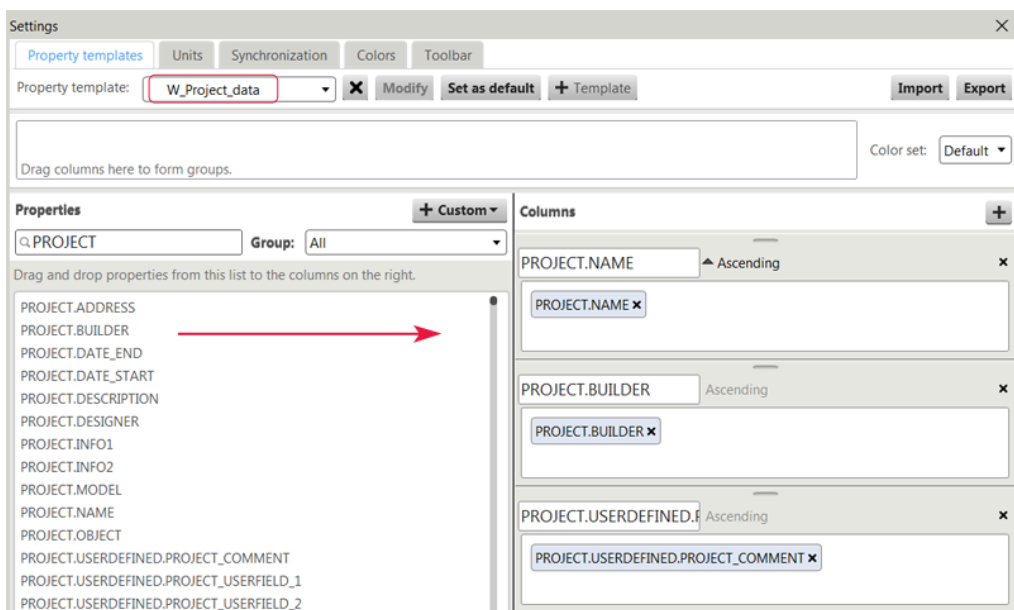

3. Add the project properties to the Excel template that you are going to use in the export and save the template.

You can copy the column headers from the property template and add them anywhere in the Excel template, see an example below.

 PO Box 1, Street address 1, 12345 City 1 Tel. 555 1234567, Fax 555 7654321 Email: first.last@company.com					
Project name:	<code>PROJECT.NAME</code>	Project number:	Author:	<code>PROJECT.BUILDER</code>	
Project address:		List date:		<code>PROJECT.USERDEFINED.PROJECT_COMMENT</code>	

NOTE If you add a `DATE` type of property to the Excel, change the format of the Excel cell to `Date` to show the date correctly. A `DATE` type of property is a property that has `DATE` in the name.

NOTE If you want to add the `DATE` property to your property template to add the current date, you have to change the name of the column header to be something different than `DATE`. For example, change it to `DATE1`, and use the same text (`DATE1`) in the Excel template.

4. Export object properties and project properties from **Organizer**.
 - a. Select objects in the model or categories to view the objects in **Object Browser**.
 - b. Select a property template that you want to use in the export, for example, **Default** or **Rebar**.
 - c. Click  and select **Export**.
 - d. Select the Excel template you modified previously and click **Export**.

The values of the project properties that you added to the Excel template are shown in the exported Excel.

 PO Box 1, Street address 1, 12345 City 1 Tel: 555 1234567, Fax: 555 7654321 Email: first.last@company.com										
Project name:	Trimble Solutions Corporation	Project number:		Author:	Builder					
Project address:		List date:		Revision, date:						
Count	Name	Content type	Material type	Material	Height / mm	Length / mm	Width / mm	Volume / m3	Weight / t	Phase
3	BEAM	PART	STEEL	S235JR	290	6 000	300	0,1	0,53	1
1	BEAM	PART	STEEL	S235JR	290	5 664	300	0,1	0,5	1
1	BEAM	PART	STEEL	S235JR	290	3 156	300	0	0,279	1
2	BEAM	PART	STEEL	S235JR	290	3 000	300	0	0,265	1
7	COLUMN	PART	STEEL	S235JR	390	7 200	300	0,1	0,899	1
Total						83 220		1,2	9,189	
All objects in the table:										
14										

See also

[Export a property template from Organizer \(page 34\)](#)

1.3 Create a property template in Organizer

You can create property templates in **Organizer** to view the properties of selected model objects in **Object Browser**. For example, you can create templates for different object types and object groups, and include the needed object properties in the template. You can group and sort the properties in the template. You can also modify existing templates.

1. To open **Organizer**, click **Manage** on the ribbon and then click **Organizer**.
2. Click  in the upper-right corner of **Organizer** to open the **Settings**.

3. If you want to create the new property template based on a current template, select the template from the list of templates.

You can modify an existing template by selecting it from the list of templates and changing the properties included in it.



4. Click  **Template**.
5. Enter a unique name for the property template.
Create is dimmed if you enter the name of an existing template.
6. Select whether the template is created based on the current template or as a blank template.
7. Click **Create**.

Property templates are saved to the `ProjOrg` database in the `\ProjectOrganizer` folder in the model folder. The saved property templates are shown in the property template list.

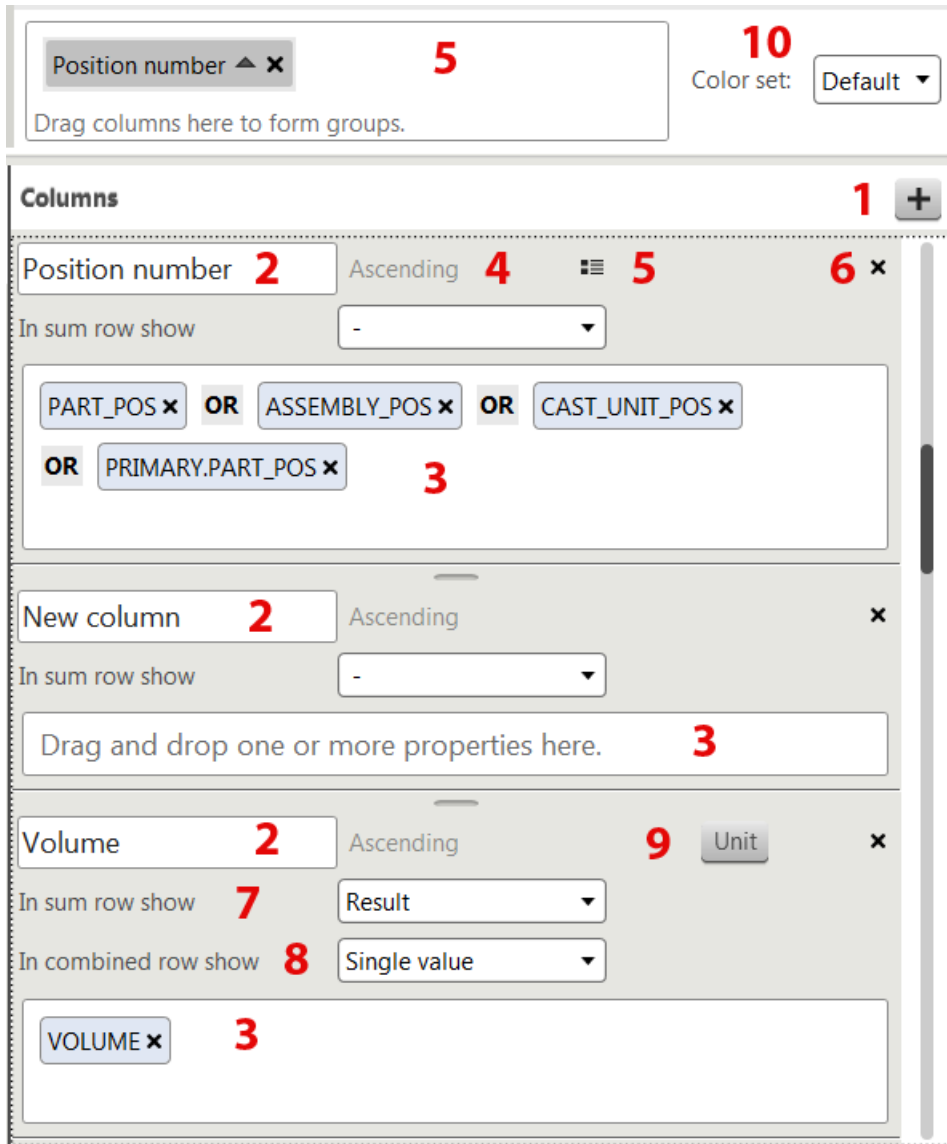
8. Do any of the following to define the properties that are included in the template:



Option in image	Description
1	Create a new property column.
2	Enter a name for a new property column or rename a property column.
3	<p>Drag one or more object properties from the list of properties to a property column.</p> <p>The properties are read from the <code>environment.db</code> file in the model folder.</p> <p>If you need properties that are not available in the list, for example reference model object properties, you can create them in Organizer as custom properties (page 28).</p>

Option in image	Description
	<p>You can use the search box to easily find the relevant properties.</p> <p>In the Group list, you can select an option to show only certain properties, for example:</p> <ul style="list-style-type: none"> • Select Recent to view the most recently used and created properties. • Select Custom to view imported properties and the properties you have created in Organizer. • Select Property templates to view the properties that are used in the property templates of your model.
4	Click Ascending or Descending to change the sorting order in a property column.
5	Drag a property column to the grouping row. The grouping icon  is shown in the property column.
6	Delete a property column.
7	<p>Select the property value shown in the sum row in Object Browser:</p> <ul style="list-style-type: none"> • - (minus) does not show any value. • Single value shows a single property value. The single value is shown if all the objects have the same property value in the column. • Result shows the sum of all the property values in the column.
8	<p>Select the property values shown in combined rows in Object Browser:</p> <ul style="list-style-type: none"> • Single value shows a single property value. • Result shows the sum of the property values.
9	Click  to set the unit and the precision of the unit for a property column.
10	Select a color set (page 32) for the template.

9. Click **Modify** to save the properties to the template.
10. To permanently save the template and the changes you have made to it, save the Tekla Structures model.

TIP You can save the property templates to a `\ProjectOrganizerData` system folder to make them automatically available in all models. For information on how to use the firm, project and system

folders with **Organizer**, see [Customized default setup for Organizer \(page 57\)](#).

Example of using multiple object properties

It can be useful to have multiple object properties in one column. This way you can ensure that the relevant property value is found for different object types.

For example, you can include different name properties in the **Name** column. **Object Browser** shows `NAME` for parts, `ASSEMBLY_NAME` for assemblies, `CAST_UNIT_NAME` for cast units, and so on.

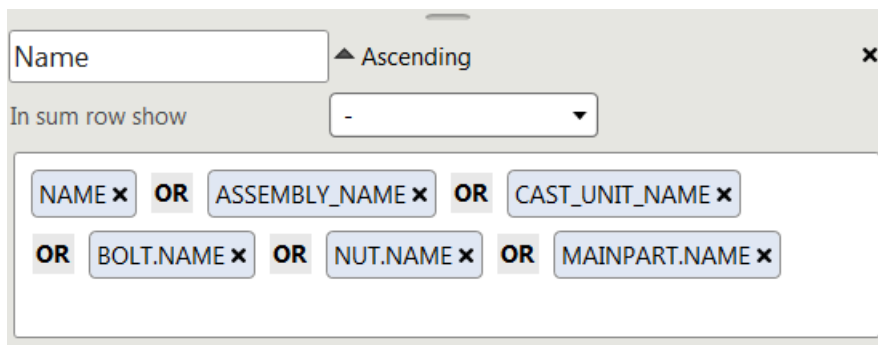

When searching for the properties, **Object Browser** uses the order, from left to right, in which the properties are shown in the column. Once a value is found, the rest of the properties in the column are ignored.

See also

[Create a custom formula in Organizer \(page 30\)](#)

Create a custom property in Organizer

You can create your own properties in **Organizer** and use these properties in property columns in the same way as any other properties. If you want to use the properties in the model, you can add them to the model objects in property categories.

Some object properties, for example, the properties of reference model objects are not automatically available in **Organizer**. To use these properties in **Organizer**, create them as custom properties.

1. To open **Organizer**, click **Manage** on the ribbon and then click **Organizer**.
2. Click  in the upper-right corner of **Organizer** to open the **Settings**.
3. Click **Custom**.
4. Select **Property**.

5. Enter a name for the property in the **Name** box.

This name is shown in the list of properties. Ensure that there are no space characters before or after the name.

6. Enter the exact name of the property in the **Property** box.

Organizer uses this name to search for the property value. Ensure that there are no space characters before or after the name. For **UDA** type properties, the maximum length is 19 characters.

NOTE For reference model object properties you must add `EXTERNAL.` at the beginning of the property name, for example, `EXTERNAL.Tekla Reinforcement.Rebar Mark`. You can copy the exact name of the property from the **Inquire object** dialog, for example.

7. Select a unit type for the property.

Organizer automatically selects the default **Data type** value of the unit type. You can change the data type.

8. Select a data type for the property.

9. Select a property type for the property.

Use **UDA** when creating properties that you write to the model.

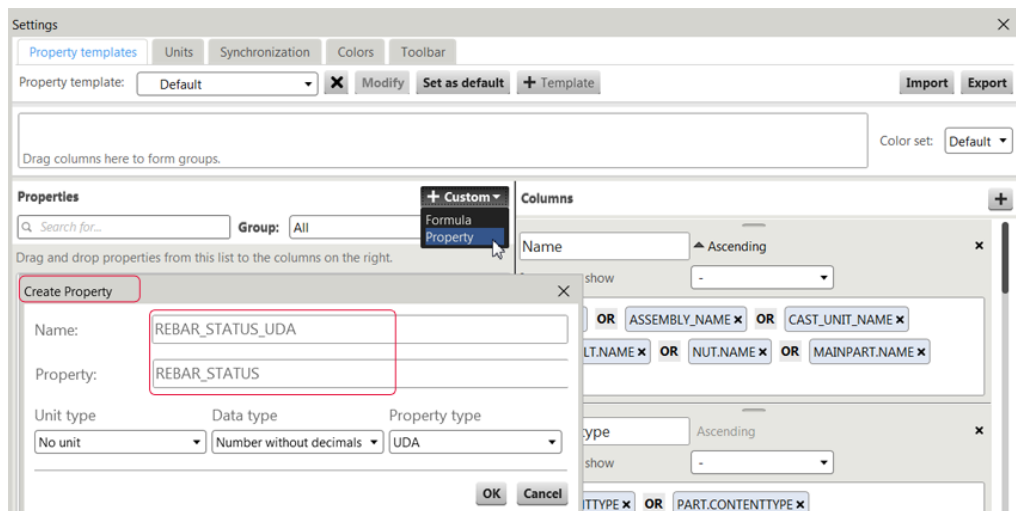

10. Click **OK**.

Custom properties are shown in the list of properties in the **Custom** group. **UDA** properties are also shown in the **UDA** group. You can modify and delete custom properties by right-clicking the property.







See also

[Create a property template in Organizer \(page 24\)](#)

Create a custom formula in Organizer

You can create simple mathematical formulas using the object properties that are available in **Organizer**. You can, for example, calculate areas of specific object types. You can add formulas to property columns in the same way as object properties. You can also use formulas in the object properties when creating property categories.

1. To open **Organizer**, click **Manage** on the ribbon and then click **Organizer**.
2. Click  in the upper-right corner of **Organizer** to open the **Settings**.
3. Click **Custom**.
4. Select **Formula**.
5. Enter a name for the formula.
Ensure that there are no space characters before or after the name.
6. Enter a property name in the search box in the **Settings** dialog to find a property.
You can also select an option from the **Group** list to narrow down the selection of properties shown in the list of properties.
7. Drag the needed properties to the formula box in the **Create Formula** dialog.
8. Drag the needed mathematical operators to the formula box and place them between the properties.

-     to add the main mathematical operation signs.
-   to add parentheses.
-  to add a box where you can enter a number.

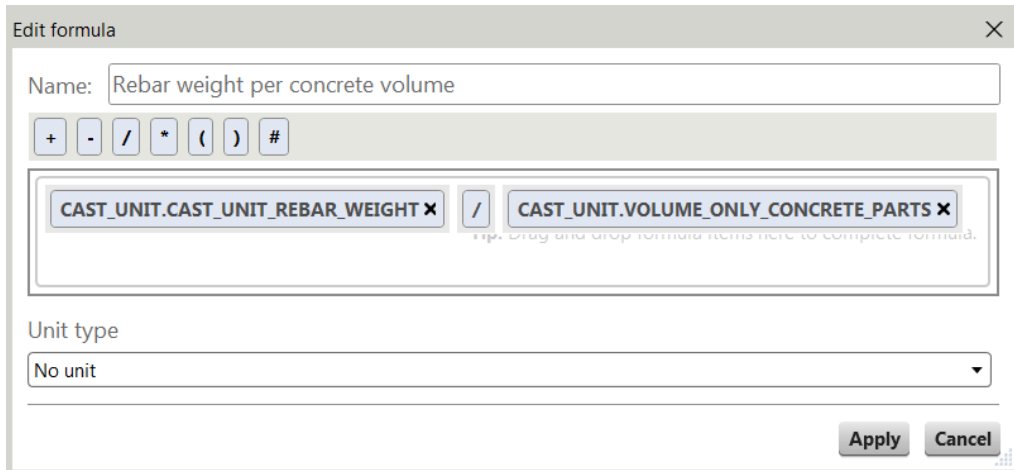

- If needed, drag the properties and operators inside the formula box to modify the formula.

Organizer automatically checks whether the formula is mathematically correct. If the formula is not correct, **Create** is dimmed and the incorrect parts are shown in red.

- Select a unit type that is suitable for the properties used in the formula.
- Click **Create**.

The formula is shown in the list of properties in the **Custom** group. You can modify and delete custom formulas by right-clicking the formulas in the list of properties. You can use custom formulas in property templates by dragging the formulas to property columns.

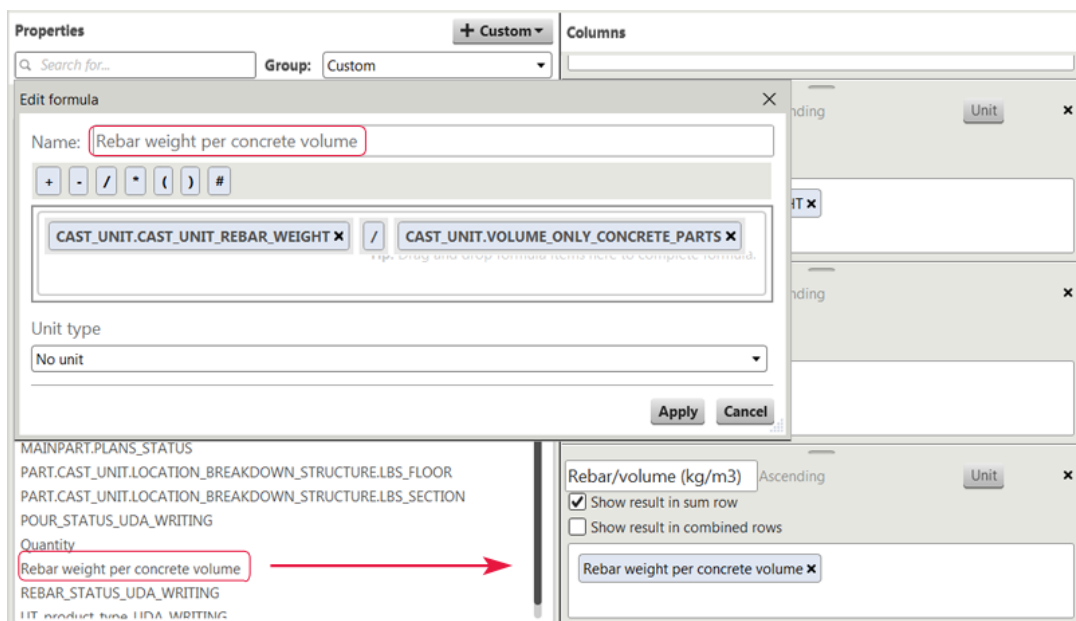

See also

[Create a property template in Organizer \(page 24\)](#)

Create a color set in Organizer

You can use colors to visualize the content of **Object Browser** groups in the model. The colors are included in color sets that you can create and modify. You can include a color set in a property template so that a property template always uses certain colors. The color visualization is for viewing purposes. You cannot save the colors in the model or in **Object Browser**.

1. To open **Organizer**, click **Manage** on the ribbon and then click **Organizer**.

2. Click  in the upper-right corner of **Organizer** to open the **Settings**.

3. Go to the **Colors** tab.

4. Click .

The color set is created based on the set that is currently selected.

5. Enter a unique name for the color set.

6. Click **Create**.

7. Do any of the following to define the colors that are included in the color set:

- Double-click a color to modify it.
- Drag the colors to arrange them to a different order.

The colors are used in **Object Browser** in the order in which they are listed in the color set. The topmost group in **Object Browser** gets the first color, the next group gets the second color, and so on.

- Right-click a color and select to add, delete, cut or copy the color.
- Double-click an added color to modify it.

You can select multiple colors by using the **Ctrl** and **Shift** keys.

- Click **Reset colors** to restore the colors of the **Default** set.

8. If needed, click **Set as default** to use the color set as the default set in **Organizer**.

9. Click **Modify**.

Organizer keeps the settings you have defined in the new color set. If you do not click **Modify** and close the **Settings** dialog, the new color set has the same settings as the color set you used as a basis for the new set.

TIP You can export color sets from **Organizer** in the `xml` format and use the sets in other models. You can export one set at a time. The color set file has the `.colorset` file extension.

You can import color sets that have been exported from the current model or other Tekla Structures models as in the `xml` format. You can import several files at a time.



See also

[Create a property template in Organizer \(page 24\)](#)

[View object properties in Organizer \(page 8\)](#)

Delete a property template in Organizer

You can delete property templates in **Organizer Settings**.

1. To open **Organizer**, click **Manage** on the ribbon and then click **Organizer**.
2. Click  in the upper-right corner of **Organizer** to open the **Settings**.
3. Select a property template from the list of templates.
4. Click  to delete the selected property template.

See also

[Create a property template in Organizer \(page 24\)](#)

1.4 Import a property template to Organizer

You can import to **Organizer** property templates that have been exported from the current model or other Tekla Structures models. Property templates are in the `xml` format. You can import one or multiple templates at a time.

You can save the property templates to a `\ProjectOrganizerData` system folder to make them automatically available in all models. For information on how to use the firm, project and system folders with **Organizer**, see [Customized default setup for Organizer \(page 57\)](#).

1. To open **Organizer**, click **Manage** on the ribbon and then click **Organizer**.
2. Click  in the upper-right corner of **Organizer** to open the **Settings**.
3. Click **Import**.
4. Select the property template file you want to import.
Property template files have the `.propertytemplate` file extension.

5. Click **Open**.

The file is imported and shown in the property template list in **Organizer**. If an existing template has the same name as the imported file, **Organizer** adds a running number to the name of the imported file.

Organizer displays an error message if the selected file is not a valid property template file and does not import the file.

If the imported template contains properties that are not in the list of properties in **Organizer**, these properties are added as custom properties.

See also

[Export a property template from Organizer \(page 34\)](#)

1.5 Export a property template from Organizer

You can export property templates from **Organizer** to `xm1` format files and use the exported templates in other models. You can export one or multiple templates at a time. Exporting the templates also ensures that you have back-up copies of the templates you have created.

For information on how to use the firm, project and system folders with **Organizer**, see [Customized default setup for Organizer \(page 57\)](#).

1. To open **Organizer**, click **Manage** on the ribbon and then click **Organizer**.
2. Click  in the upper-right corner of **Organizer** to open the **Settings**.
3. If you want to export a specific property template, select the template from the list of templates.
4. Click **Export**.
5. Select whether to export the current property template or all property templates.
6. Click **Browse** to select the destination folder.
By default, the templates are exported to the `\ProjectOrganizer` folder in the current model folder.
7. Click **Export**.

Each exported template creates a separate `xm1` format file. The file extension is `.propertytemplate`.

See also

[Report object property values from Organizer \(page 20\)](#)

[Import a property template to Organizer \(page 33\)](#)

1.6 Categories in Organizer

You can categorize your model in location categories and other type of categories that you can create based on your needs using for example object properties.

- Using location categories, you can create a location breakdown structure and divide the model into projects, sites, buildings, sections and floors. A project contains all the objects of the models that are selected in the category properties, either the Tekla Structures model or reference models, or both. Within a project, a model object can belong to only one lowest level location category at a time.

Data related to location categories (for example, floor, building) is only written to the highest level assemblies. For example, a precast cast unit inside the first floor will receive `FLOOR 1` as a property, but the rebars in the cast unit will not.

Organizer always creates an uncategorized category in a project for objects that cannot be included in any other category based on the location definitions you have made. You can modify the definitions to include the objects to location categories.

- Property categories allow you to add user-defined attributes (UDA) to model objects. Within a property category, a model object can belong to only one lowest level category at a time.
- Custom categories are created based on the rules that you define. Objects are added to the categories based on these rules. You can also create categories manually without rules.

NOTE You can define whether **Organizer** uses pour units or cast-in-place cast units as the highest cast-in-place hierarchy level in the categories. To use pour units, set the `XS_ENABLE_POUR_MANAGEMENT` advanced option to `TRUE` and reopen the model. Then, click  in the upper-right corner of **Organizer** to open the **Settings**, and go to the **Synchronization** tab. Select **Pour units enabled** to use pour units.

Organizer is fully synchronized when you close the **Settings** dialog.

An example of a default category set in **Organizer**:

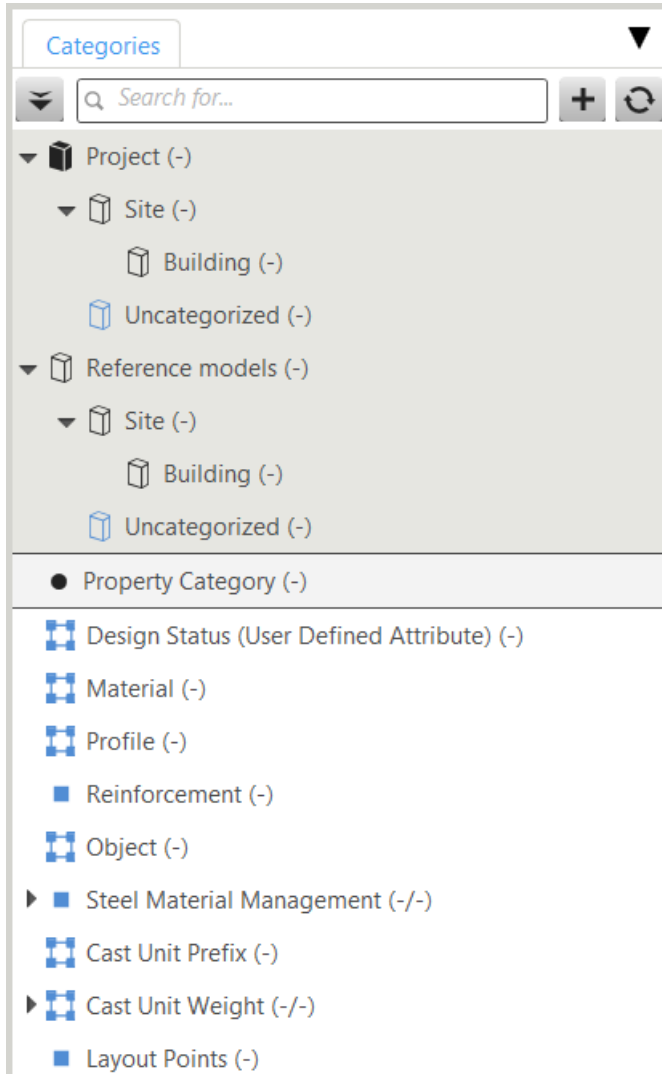

When you have included objects in the categories:

- The number of objects in a category is shown in parentheses for location categories and property categories, and for lowest level custom categories.
- The number of objects in a category and the total number of objects included in the category and its subcategories is shown in parentheses for custom categories, as shown in the image below.

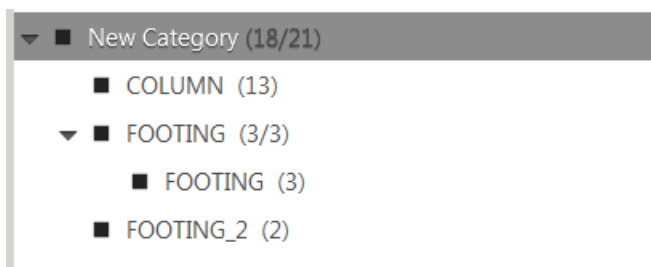

See also

- [Create location categories in Organizer \(page 37\)](#)
- [Create location categories manually in Organizer \(page 42\)](#)
- [Create a property category in Organizer \(page 43\)](#)
- [Create a custom category in Organizer \(page 47\)](#)
- [Create automated subcategories in Organizer \(page 50\)](#)
- [Modify a category in Organizer \(page 52\)](#)
- [Delete a category in Organizer \(page 57\)](#)
- [Customized default setup for Organizer \(page 57\)](#)
- [Excluding object types from Organizer \(page 59\)](#)

Create location categories in Organizer

You can create location categories by defining boundary boxes for the categories. This functionality allows you to organize model objects to sections and floors. The objects are automatically updated to categories based on their locations and the defined boundaries. If an object is not inside or within the limits of a boundary box, it will be placed in an uncategorized category that is automatically created.

1. To open **Organizer**, click **Manage** on the ribbon and then click **Organizer**.
2. Select **Building** in the category tree.
3. Right-click and select **Define boundary boxes for locations**.
4. On the **Building** tab, define the boundary box for the building.

- a. If there are several grids in the model, select a grid for this building from the **Grid origin in the model** list.

The grid selection is available only if there are several grids. The grid selection shows the global x, y and z coordinates of the grid origins and the rotation of grids compared to the model origin coordinates.

Note that if the building already contains floors, grid selection is not available. Create a new building to use grid selection and to create floors based on grids.

When you have selected a grid for a building, we recommend that you do not make changes to the grid in the model. But if you do, remember to manually update the grid coordinates here in this dialog, too.

- b. If needed, change the default name of the building.

- c. Define the x, y and z coordinates for the building boundary box by selecting the boundary coordinates from the list, or by entering suitable coordinates in the boundary coordinate boxes.
- d. Click the  icon in front of the building to view the boundary box in the model.

The image below shows an example of building coordinates.

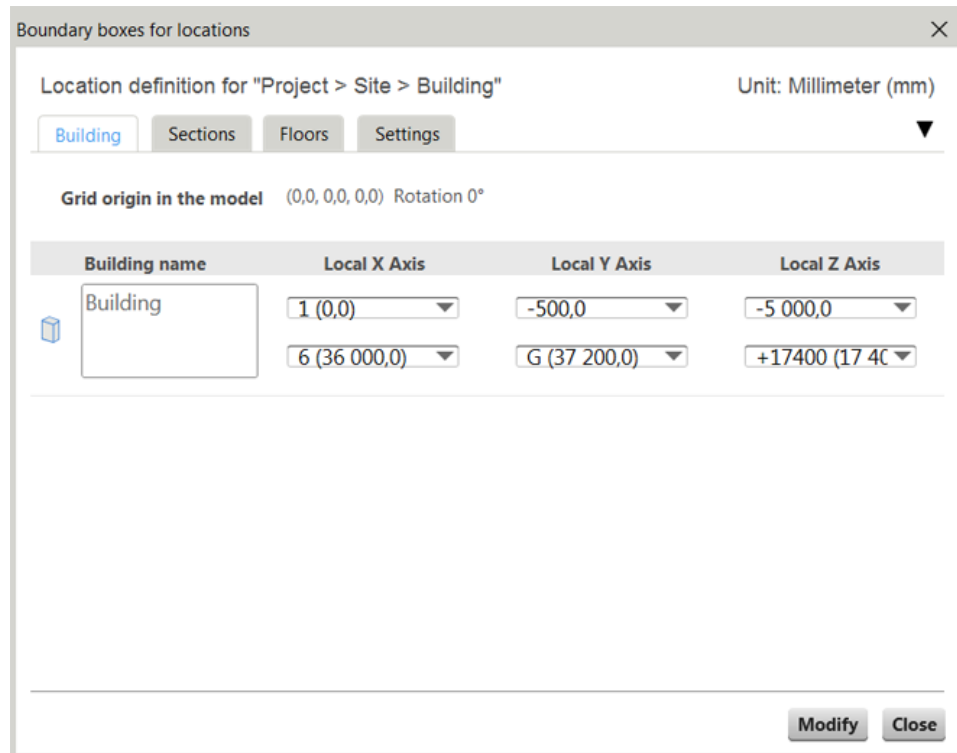

Building name	Local X Axis	Local Y Axis	Local Z Axis
 Building	1 (0,0)	-500,0	-5 000,0
	6 (36 000,0)	G (37 200,0)	+17400 (17 400)

- e. Right-click in the model and select **Update window** to remove the boundary box from the model view.
5. On the **Sections** tab, define the boundary boxes for sections.

- a. Click  to create one or more sections.
- b. If needed, change the default names of the sections.
- c. Define the x, y and z coordinates for the section boundary box by selecting the boundary coordinates from the list, or by entering suitable coordinates in the boundary coordinate boxes.

Ensure that the sections do not overlap and that they are inside the building boundary box. A red exclamation mark is shown in front of the coordinates if the boundary boxes overlap. You can save the location definitions when the boundary boxes do not overlap.

- d. Click the  icon in front of the section to view the boundary box in the model.

The image below shows an example of section coordinates.

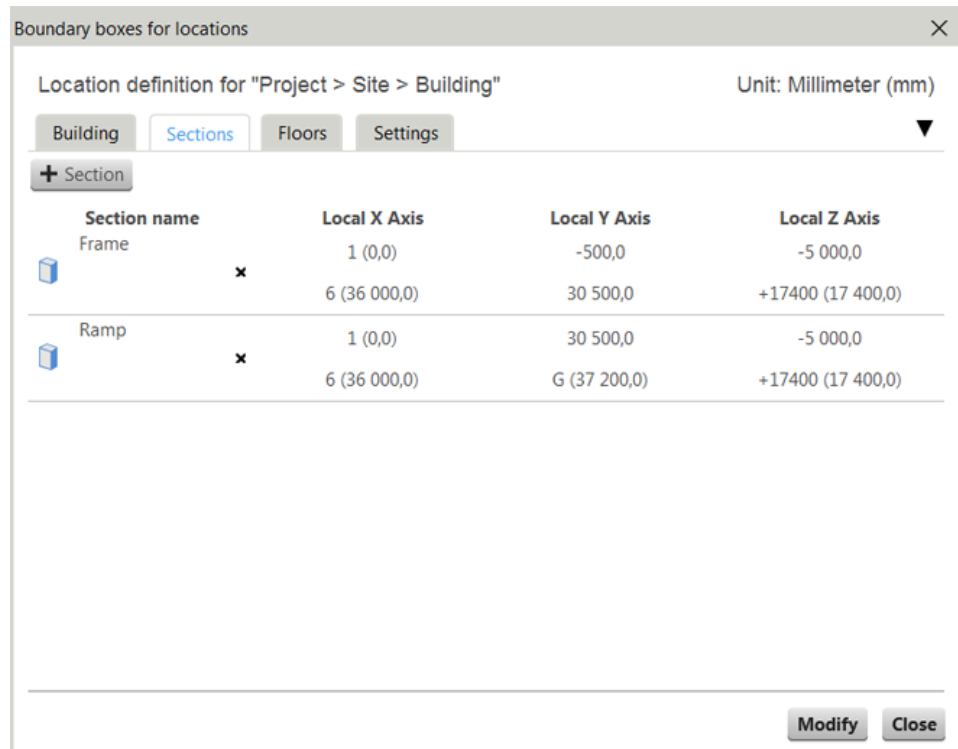

- e. Right-click in the model and select **Update window** to remove the boundary box from the model view.
6. On the **Floors** tab, define the boundary boxes for floors.
- a. Click the **Floor system** button.
You can add as many floor systems as you need. The added floor systems are available in the list.
 - b. If needed, enter a name for the floor system.
 - c. Do one of the following:
 - Click **+ Floor** to add a top floor to the floor system.
You can enter the height of the top floor in the box next to the button.
 - Click **+ Floors based on grid** to create floors automatically based on the grid levels.
Grid selection is available on the **Building** tab for buildings that do not have floors defined yet.
 - d. If needed, change the default names of the floors.
 - e. Define the z coordinates for the floors by selecting the boundary coordinates from the list, or by entering suitable coordinates in the boundary coordinate boxes.

- f. Select a building or a section in which the floor system is used from the list in the box at the top right.

If you have not defined sections, the buildings are shown. The building or section is added to the box.

Floor systems can be used in several buildings and sections. If the floor system is used in some other building and you want to remove the floor system from that other building, you need to open the boundary box definitions of that other building and make the modifications there.

- g. Click the  icon in front of the floor to view the boundary box in the model.

The image below shows an example of floor coordinates.

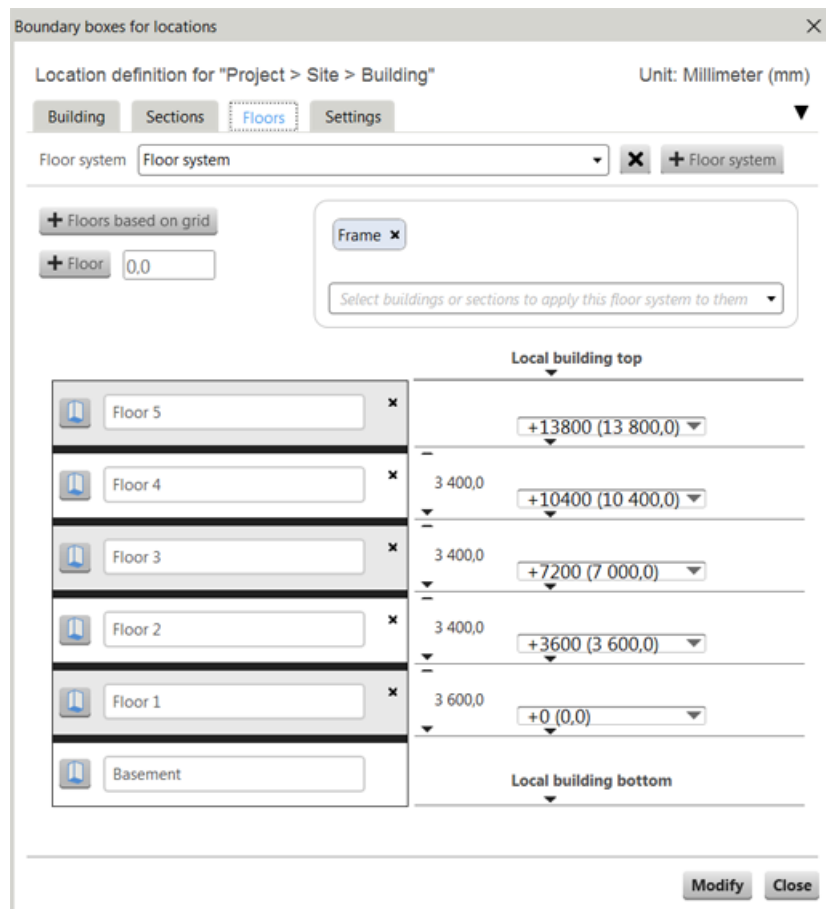

- h. Right-click in the model and select **Update window** to remove the boundary box from the model view.
7. On the **Settings** tab, define how objects are placed in the categories.

Organizer checks the selected options in the order in which they are shown on the **Settings** tab, from top to bottom.

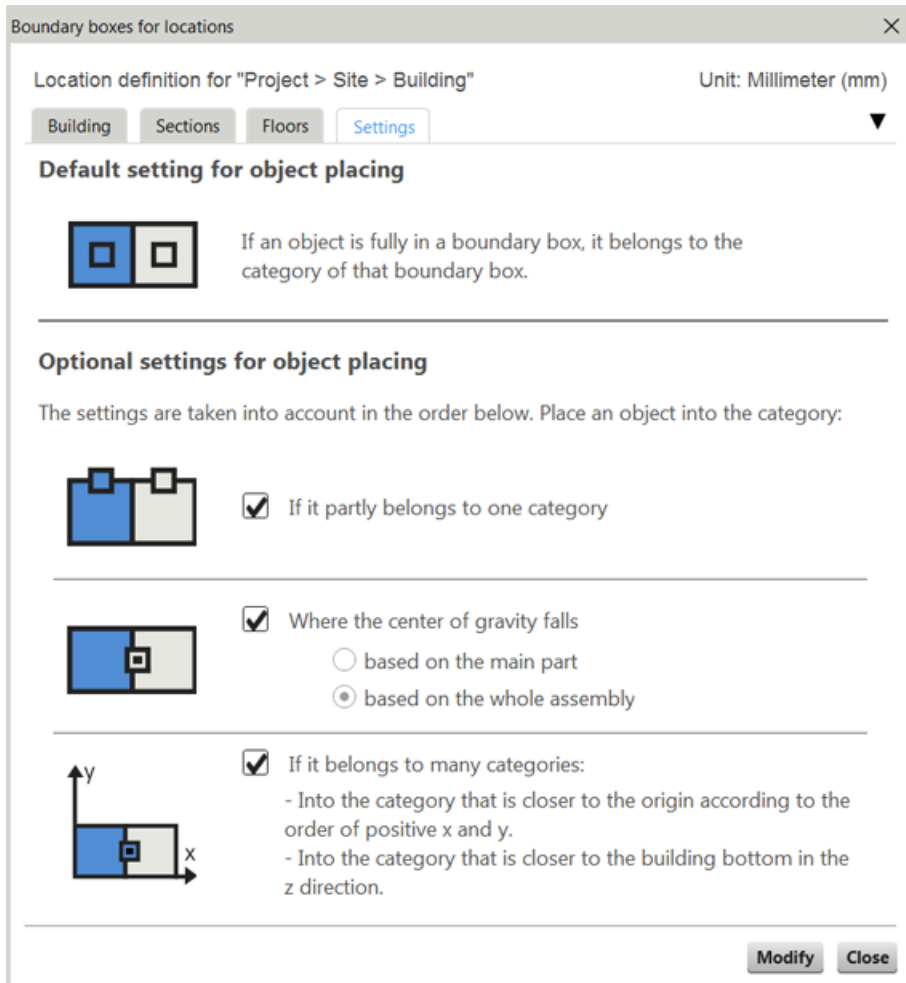

The objects that cannot be included in categories based on the default and the selected optional settings are placed in an **Uncategorized** category that is created automatically on the relevant level. You can either modify the boundary coordinates or manually move the objects to the correct location.

Note that if you have more than one project, you cannot move objects from one project to another.

8. Click **Modify** and **Close**.
9. Right-click any category in the project and select **Synchronize category** to refresh the category content from the model.

You can also click  to synchronize **Organizer**.

When you have created the categories, the icons in front of the categories are shown as blue in the category tree.

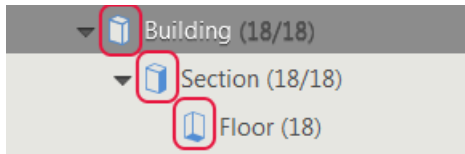

Copy a project to property categories or custom categories

You can copy any **Project** from the location categories to the property categories or custom categories.

1. Select the **Project** that you want to copy.
2. Drag the **Project** to the property categories or custom categories in the category tree.

Organizer shows a thick line in the location to which you can copy the **Project**.

3. Select the appropriate copy option:
 - **Copy** to copy the **Project** tree structure and the objects
When you copy a **Project** using this option and later make changes in the **Project** in the location categories, the changes are automatically shown in the copied **Project**.
 - **Copy only the tree structure** to copy the **Project** tree structure

NOTE If you select a Tekla Structures model in the category properties, all assemblies, cast units, or pour units are included.

If you select any of the reference models in the category properties, the reference assemblies or reference objects are included. If there are no assemblies in a reference model, then the reference objects are included.

See also

[Categories in Organizer \(page 35\)](#)

[Modify a category in Organizer \(page 52\)](#)

[Delete a category in Organizer \(page 57\)](#)

Create location categories manually in Organizer

You can manually create location categories without defining boundary boxes for the categories.

1. To open **Organizer**, click **Manage** on the ribbon and then click **Organizer**.

2. Select a **Project**, right-click and select **New site**.
You can also select **New project** to have **Organizer** automatically create **Site** and **Building** under the project.
3. Right-click the **Site** you created and select **New building**.
4. Right-click the **Building** you created and select **New section** or **New floor**.
5. Right-click the **Section** you created and select **New floor**.
You can create as many projects, sites, buildings, sections, and floors as you need.
6. Add objects to the categories. Do one of the following:
 - Select a category in the project to show the model objects in **Object Browser** and select the objects that you want to move to the new category. Then drag the objects to the new category.
 - In the model, select the objects that you want to move, right-click the new category and select **Move the selected objects**.

NOTE You cannot move objects from one project to another. Within a project, you can move model objects between the lowest level categories. One object can belong to only one lowest level location category at a time.

When you have created the categories manually, the icons in front of the categories are shown as black in the category tree.

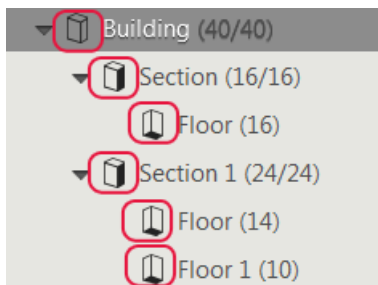

See also

[Categories in Organizer \(page 35\)](#)

[Modify a category in Organizer \(page 52\)](#)

[Delete a category in Organizer \(page 57\)](#)

Create a property category in Organizer

You can create property categories to add properties to model objects. You can use existing user-defined attributes (UDAs) in the categories and add

values to them, or you can create UDAs as custom properties in **Organizer** and use these in the property categories.

NOTE If you have several property categories, you can use a certain UDA in only one root level property category. This ensures that other categories do not overwrite the UDA.

1. To open **Organizer**, click **Manage** on the ribbon and then click **Organizer**.
2. In **Categories**, select a property category at the root category level, right-click and select **Properties**.

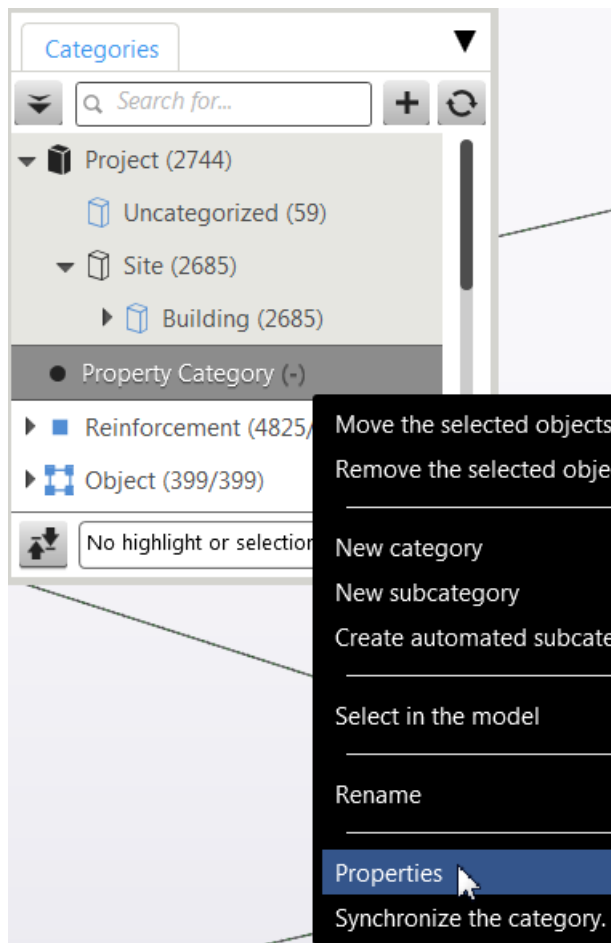

3. [Add content to the category \(page 47\)](#). Properties are added to the objects that are in the category.

You can do the following:

- a. Add the category content [manually \(page 52\)](#) by selecting objects in the model and inserting them to the category, or by defining rules that automatically insert objects to the category.

- b. [Add subcategories \(page 50\)](#) to the category. Subcategories can be added manually or automatically based on a property. The property values are written to objects from lowest level categories.
 - c. Select the **Do not delete empty automated subcategories** checkbox to keep all subcategories at synchronization. If you do not select the checkbox and change the model so that some, or all of the subcategories do not contain any objects, the empty subcategories are deleted when you synchronize the root category or the whole **Organizer**.
 - d. Select the **Include the highest assembly level in the model** option if you want to ensure that only highest level assembly objects are inserted to the category. **Organizer** shows either cast-in-place cast units or pour units at the highest cast-in-place hierarchy level, depending on whether you have selected the **Pour units enabled** setting in **Organizer Settings**  **> Synchronization**. To use the **Pour units enabled** setting, set the `XS_ENABLE_POUR_MANAGEMENT` advanced option to `TRUE`.
4. Under **Object properties**, select a custom property or an existing UDA. You can add more than one property.
 5. Define the property settings:

Property	Type	Value	Unit
comment	Text		

Select a property...

- a. Select the value type from the **Type** list and define the value in the **Value** box.
The type determines what kind of values you can use.

Type of UDA	Type	Value
String	Text	Enter text or a number.
	Category name	Organizer adds the name of the category to the Value box automatically.
	Combined category names	Organizer adds the names of the categories to the Value box automatically.
Integer	Number without decimals	Enter a number.
Double	Number with decimals	Enter a number with decimals.

Type of UDA	Type	Value
	Formula	Select a formula from the Value list. Formulas are defined in Organizer Settings .
Date	Date	Enter a date or select it from the calendar.

- b. Select a unit for the value from the **Unit** list.
Only the possible unit options are available for the property:
 - The units of the properties are defined in `contentattributes_userdefined.lst` or `object.inp` files.
 - The units of custom properties that are created in **Organizer** are defined when creating the property.
- c. Modify the properties in the subcategories if you want the subcategories to have different property values for the same property.
 - If you want a property to use the property value defined on the higher property category level, select the **Inherit value** checkbox after the property name.
 - If you have selected the **Inherit value** checkbox but select a type in the **Type** box or enter a value in the **Value** box, the **Inherit value** checkbox is cleared automatically.

NOTE The property values are written to the objects from the lowest level subcategories.

When you write the custom properties you have created in **Organizer** to the model, you can use these properties as any other UDAs in the model.

When the properties are written to the model, you can use them in visualization and IFC export, for example. You can also view the properties in object dialogs and share them with Tekla Model Sharing.

6. Clear the **Update category at synchronization** checkbox if you do not want to update the category when you synchronize the whole **Organizer** with the model.
7. Click **Modify**.
Organizer creates an **Uncategorized** category for the objects that are not included to the lowest level categories yet. If the same objects would belong to more than one subcategory based on the category rules, **Organizer** creates a **Clashing** category for these objects. You need to modify the category rules to empty the **Clashing** category.

8. Click  to synchronize **Organizer**, or select any category in the property category tree, right-click and select **Synchronize category**.

Properties and their values are written to the model objects when **Organizer** or the category is synchronized. **Uncategorized** and **Clashing** categories do not modify the existing UDA values.

You can inquire the properties written to the model and [report \(page 181\)](#) them as any other properties.

NOTE If you delete a property category and its subcategories, the properties that have already been written to the model are not removed.

UDAs with options

If you add UDAs with options to a property category when writing properties to the objects, you have to use the UDA - <property name> format.

To get the correct report result in **Object Browser**, you can use the same property without UDA - in the name.

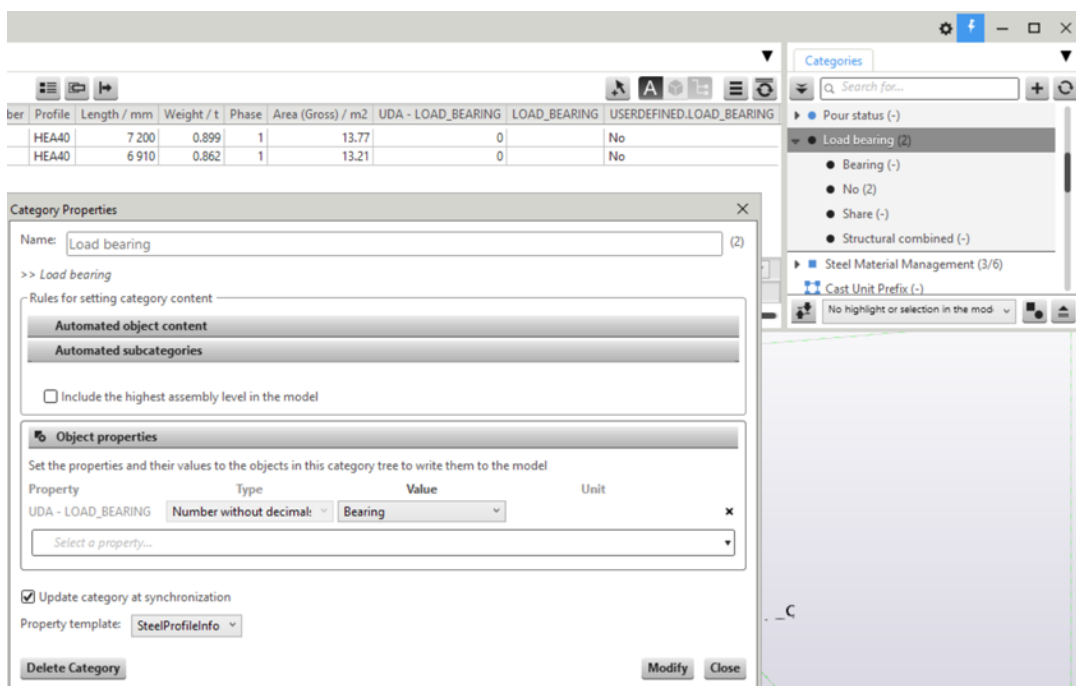

See also

[Categories in Organizer \(page 35\)](#)

[Example: Organizer for precast \(page 124\)](#)

Create a custom category in Organizer

You can create custom categories to group model objects, for example, based on object properties.

1. To open **Organizer**, click **Manage** on the ribbon and then click **Organizer**.
2. Click  to create a new category.
If you have a category selected, the new category is created on the same level as the selected category. If you have several categories selected or do not have any category selected, the new category is created at the root category level. You can add as many categories as you need.
3. Right-click the new category and select **Properties**.
4. Type a name for the category.
5. Define the rules for setting the category content:

- a. Under **Automated object content**, select the models, filters and categories that are used to automatically add objects to the category. Do any of the following:

- Click the **Select model** list and select a model to add its objects to the category.

To include all model objects in the category, select the Tekla Structures model.

- Drag a category from the category tree to the categories and filters rule box, or click or type in the box and select a filter from the list.
- Click **Object group** to define a filter for **Organizer**.

The **Object Group - Organizer** dialog opens in the Tekla Structures main view. When you have saved the filter, click or type in the rule box again and select the filter.

Organizer filters are saved in the `\attributes` folder of the model folder with the `.OrgObjGrp` file extension. You can use these filters only in **Organizer**.

You can add as many filters and categories as you want to the same rule box.

If you add more than one category or filter to the same rule box, the category content is a union of all the objects in them.

If you add categories or filters to separate rule boxes, select whether the category content is an intersection or difference of the content of the boxes.

NOTE You can also separately create filters for **Organizer** before creating any categories. These filters are created in the same way as Tekla Structures selection and view filters, and you

can use them in category rules. When creating the filters, click  in the filter settings and set **Organizer** as the filter type. Then define the settings needed in the filter.

- b. Under **Automated subcategories**, select the properties that are used to create the subcategories. Do the following:
- Click **Grouping in Object Browser**.
To use this option, drag one or more property columns to the [grouping \(page 15\)](#) row in **Object Browser**. **Organizer** uses the properties included in the columns when creating the subcategories.
You can also add property template columns or object properties to the rule boxes.
 - Click the rule boxes and select a property template column or an object property.
Note that you cannot use the **Grouping in Object Browser** option if you first add property template columns or object properties to the rule boxes.
You can add more than one column or property to the same rule box.
Organizer adds a new subcategory level to the properties dialog when you have added a column or a property to the rule box. If you want the category to have the new subcategory level, add columns or properties to the rule boxes on the new subcategory level.
 - Select the **Do not delete empty automated subcategories** checkbox to keep all subcategories at synchronization.
If you do not select the checkbox and change the model so that some, or all of the subcategories do not contain any objects, the empty subcategories are deleted when you synchronize the root category or the whole **Organizer**.
- c. Select the **Include the highest assembly level in the model** option if you want to ensure that you have only assembly level objects in the category.
When you select this option and add a model object to the category, the assembly to which the object belongs will be added to the category.
Organizer shows either cast-in-place cast units or pour units at the highest cast-in-place hierarchy level, depending on whether you have selected the **Pour units enabled** setting in **Organizer Settings** 

> **Synchronization.** To use the **Pour units enabled** setting, set the `XS_ENABLE_POUR_MANAGEMENT` advanced option to `TRUE`.

6. Clear the **Update category at synchronization** checkbox if you do not want to update the category when you synchronize **Organizer** with the model.
7. Select a default property template for the category from the **Property template** list.
This is the property template that is shown in the **Object Browser** property table.
8. Click **Modify**.

TIP You can manually add categories and subcategories to automated categories. Select a category, right-click and select **New category** or **New subcategory**. Manually added categories are not deleted at synchronization. When you synchronize a manually created subcategory, only that category is synchronized.

See also

[Customized default setup for Organizer \(page 57\)](#)

[Categories in Organizer \(page 35\)](#)

[Modify a category in Organizer \(page 52\)](#)

[Delete a category in Organizer \(page 57\)](#)

Create automated subcategories in Organizer

You can create an automated subcategory tree structure for one or several custom categories at a time.

Note that the categories for which you create the automated subcategories cannot already have subcategories. If you use an empty category that does not contain any objects yet, only the category rules are saved.

1. To open **Organizer**, click **Manage** on the ribbon and then click **Organizer**.
2. Select a custom category, right-click and select **Create automated subcategories**.

Organizer opens the **Automated subcategories** section in the category properties dialog.

3. You can use the following two methods to define the properties that are used to create the subcategories:
 - In **Object Browser**, click  to enable grouping.

Drag one or more property columns to the [grouping \(page 15\)](#) row in **Object Browser**. **Organizer** uses the properties included in the

columns when creating the subcategories, for example, as shown in the image below.

Click **Grouping in Object Browser** in the category properties dialog. Note that you cannot use the **Grouping in Object Browser** option if you first add property template columns or object properties to the rule boxes.

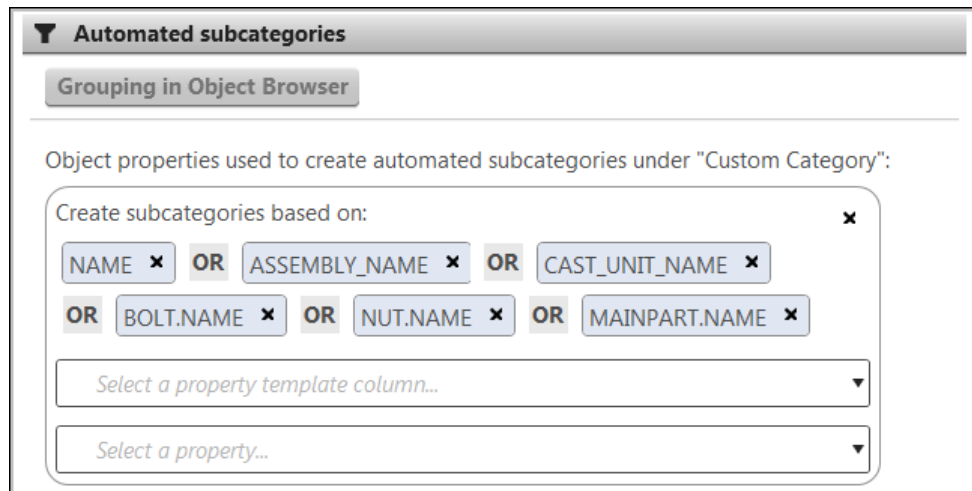

- You can also add property template columns or object properties to the rules by selecting them from the lists in the category rule boxes.

Click the rule boxes and select a property template column or an object property.

You can also type the name of the property in the box, for example, `PROFILE` and press **Enter**. You can add more than one column or property to the same rule box.

Organizer adds a new subcategory level to the properties dialog when you have added a column or a property to the rule box.

4. If you want the category to have the new subcategory level, add columns or properties to the rule boxes on the new subcategory level.
5. Select the **Do not delete empty automated subcategories** checkbox to keep all subcategories at synchronization.

If you do not select the checkbox and change the model so that some, or all of the subcategories do not contain any objects, the empty subcategories are deleted when you synchronize the root category or the whole **Organizer**.

6. Click **Modify**.

TIP You can manually add categories and subcategories to automated categories. Select a category, right-click and select **New category** or **New subcategory**. Manually added categories are not deleted at synchronization. When you synchronize a manually created subcategory, only that category is synchronized.

See also

[Categories in Organizer \(page 35\)](#)

[Create a custom category in Organizer \(page 47\)](#)

[Modify a category in Organizer \(page 52\)](#)







[Delete a category in Organizer \(page 57\)](#)





Modify a category in Organizer

You can modify the category rules and make manual changes to the category content.

1. To open **Organizer**, click **Manage** on the ribbon and then click **Organizer**.
2. Do any of the following:

To	Do this
Rename a category	Select a category, right-click and select Rename .
Show cast-in-place cast units or pour units as the highest cast-in-place hierarchy level	<p>To use pour units as the highest cast-in-place hierarchy level, set the <code>XS_ENABLE_POUR_MANAGEMENT</code> advanced option to <code>TRUE</code>.</p> <ol style="list-style-type: none">1. Click  to open Organizer Settings.2. Go to the Synchronization tab.3. Select or clear the Pour units enabled checkbox, depending on what you want to show in the categories. Note that when you select or clear the Pour units enabled setting, Organizer will be fully synchronized when you close the Settings dialog. Take this into account when changing the setting in large models, as synchronization may take some time. Categories with manually added objects will lose the pour unit or cast-in-place cast unit content, depending on what you have selected.4. Close the Settings dialog.
Add objects to a category	<p>You can manually add objects to a category.</p> <ol style="list-style-type: none">1. Select objects in the model or select a category.2. Select objects in Object Browser by selecting rows.3. Drag the selected objects to a category.

To	Do this
	<p>If you want to add all the objects that you have selected in the model, you can also right-click the category and select Add the selected objects.</p> <p>Click  to hold the view in Object Browser. When you hold the view, you can make selections in the model or in the categories without changing the contents shown in Object Browser. To show objects per category in Object Browser, click  and select  Separate categories.</p> <p>In location categories, when you select objects in one category and add them to another category, the objects are moved to the other category. An object can be in only one lowest level location category within a project.</p>
Remove objects from a category	<p>You can manually remove objects from a category.</p> <ol style="list-style-type: none"> 1. Select a category. 2. Select the objects in Object Browser. 3. Right-click and select Remove the selected objects from the selected categories.
Manage manual changes in a category	<p>You can view in Object Browser how each object has been included in the category, or why it is not included. Objects can be included in categories either automatically based on category rules, or you can add and remove them manually.</p> <ol style="list-style-type: none"> 1. Select a custom category. 2. Right-click the category and select Properties to view the rules used in the category. <p>The properties show whether there are manually added and removed objects in the category. You can control the status of the objects in Object Browser.</p> <ol style="list-style-type: none"> 3. Click  and select  Manage manual changes. <p>Organizer places a purple frame around Object Browser and Categories, and adds a Status column to Object Browser. In the manual change mode, a limited set of Organizer commands is available.</p> <p>Each object has a status icon:</p> <ul style="list-style-type: none"> •  <p>The object has been automatically added to the category based on the category rules.</p>

To	Do this
	<ul style="list-style-type: none"> •  <p>The object has been automatically added and manually removed from the category.</p> •  <p>The object has been automatically added to the category and manually added to the category.</p> •  <p>The object has been manually added to the category.</p> •  <p>The object has been manually removed from the category.</p> <p>Note that the status applies in the selected category. The object may have a different status in another category.</p> <p>4. Right-click an object in Object Browser to change the status:</p> <ul style="list-style-type: none"> • Add manually adds the object to the category. • Remove manually removes the object from the category. • Remove manual changes removes manual status from an object but leaves the object to the category if it has been included automatically.
Modify category rules	<ol style="list-style-type: none"> 1. Select a category, right-click and select Properties. 2. Modify the category content rules under Automated object content. <p>The  icon in the Automated object content button shows that the category has automated object content rules defined.</p> <p>Do any of the following:</p> <ul style="list-style-type: none"> • Select a model from the list of models. <ul style="list-style-type: none"> Click Model list to see which models are already used in the rules. • Drag a category from the category tree to the rule box. • Click or type in the rule box and select a filter from the list.

To	Do this
	<ul style="list-style-type: none"> • Click Object group to define a filter for Organizer. When you have saved the filter, click or type in the box again, and select the filter. You can add more than one category and filter, and create unions, intersections, or differences of them. <p>3. Modify the subcategory rules under Automated subcategories.</p> <p>The  icon in the Automated subcategories button shows that the category has automated subcategory rules defined.</p> <p>Do any of the following:</p> <ul style="list-style-type: none"> • Click the rule boxes to add more property template columns or properties to the rules. You can add more properties to the existing subcategory hierarchy levels or to the empty hierarchy level that is under the existing levels. • Remove a property from the rules. • Remove a whole subcategory hierarchy level from the rules. <p>4. Click Modify.</p> <p>You can modify the subcategory rules of several subcategories at the same time if they have the same subcategory rules, see also Create automated subcategories in Organizer (page 50).</p>
Change the default property template of a category	<ol style="list-style-type: none"> 1. Select a category, right-click and select Properties. 2. Select another property template from the Property template list. 3. Click Modify.
Modify the properties of multiple categories	<ol style="list-style-type: none"> 1. Select the categories you want to modify. 2. Right-click and select Properties. <p>The properties you can modify depend on the selected categories. You can, for example, change the default property template or subcategory rules.</p>
Change the category content to include the highest assembly level	<ol style="list-style-type: none"> 1. Select a category, right-click and select Properties. 2. Select the Include the highest assembly level in the model checkbox.

To	Do this
	<p>3. Click Modify.</p> <p>If you add parts to a category that includes only assemblies, the assembly information is shown in the category.</p>
<p>Modify the boundary boxes of a building, section or floor category</p>	<ol style="list-style-type: none"> 1. Select a category that you have created using boundary boxes. 2. Right-click and select Define boundary boxes for locations. 3. Modify the boundary box definitions. <p>If you modify a building coordinate and a section has the same coordinate, the section coordinate changes to the modified building coordinate.</p> <p>The categories you have created using boundary boxes have a blue icon in the category tree.</p>
<p>Add a floor manually to a building that has an automated location breakdown structure</p>	<p>You can manually add floors to automated buildings, for example, to collect the objects of special structures within a building into separate categories. The manually added floors do not have a boundary box for automated object collection. You can add objects from any part of the building.</p> <p>You can use the manual floor category, for example, to separate the elevator shaft from the rest of the building.</p> <ol style="list-style-type: none"> 1. Select a section under a building that has an automated location breakdown structure. 2. Right-click and select New floor. 3. Add objects to the floor. 4. Select the Project root category, right-click and select Write to the model for reporting to write the new location information to the model objects.
<p>Add a category manually to an automated category</p>	<p>You can manually add categories to automated categories. Manually added categories are not deleted at synchronization even if they do not contain any objects.</p> <ol style="list-style-type: none"> 1. Select an automated category. 2. Right-click and select either New category or New subcategory.
<p>Copy or move a category</p>	<p>You can copy or move one category and its subcategories at a time.</p> <ol style="list-style-type: none"> 1. Select a category and drag it to a suitable location in the category tree, either on top of a category or between two categories.

To	Do this
	2. Select a suitable option from the list: <ul style="list-style-type: none"> • Copy copies the category properties and the objects in the categories to the target category. • Copy only the tree structure copies the tree structure without the objects and their properties. • Move moves the category with the objects and their properties to the new location.

See also

[Synchronize Organizer with the model \(page 60\)](#)

[Categories in Organizer \(page 35\)](#)

Delete a category in Organizer

You can delete categories in **Organizer**. Note that there must be at least one location category, one property category and one custom category in the **Organizer** category tree. You cannot delete the last categories.

1. To open **Organizer**, click **Manage** on the ribbon and then click **Organizer**.
2. Select a category.
You can select more than one category.
3. Right-click and select **Delete**.
If you have used the selected category in the property rules of other categories, **Organizer** shows a dialog where these categories are listed.
4. Click **Yes** to delete.

NOTE To permanently delete a subcategory from a category created with the **Create automated subcategories** command, you must remove the subcategory objects from the main category. If you do not remove the objects from the main category, the subcategory will be created again based on the main category rules when you synchronize **Organizer**.

See also

[Categories in Organizer \(page 35\)](#)

Customized default setup for Organizer

You can customize **Organizer** by creating a setup that opens the same templates and categories in all new models. A customized setup is useful

if you have templates and categories you want to use in all models. Then you do not need to create or import the templates and categories for each model separately. The customized setup is used when you open **Organizer** in a model for the first time.

You can also [exclude some object types \(page 59\)](#) from **Organizer** using the `ExcludedTypesFromOrganizer.xml` file. Excluded object types are not displayed in **Object Browser** and they are not included in categories.

To make the customized property templates and categories available in all models, store the templates in the `\ProjectOrganizerData\PropertyTemplates` folder and the categories in the `\ProjectOrganizerData\DefaultCategoryTrees` folder. The templates and categories are stored as in the `xml` format. Property template files have the `.propertytemplate` file extension and categories have the `.category` file extension.

NOTE The defined location categories are automatically imported but they behave like manually created categories. Automatic categories need to be defined in each model separately.

You can have the folders under any or all of the following folders:

- Current model folder
- Project folder, defined in the `XS_PROJECT` advanced option
- Firm folder, defined in the `XS_FIRM` advanced option
- Folders defined in the `XS_SYSTEM` advanced option

Example of folders:

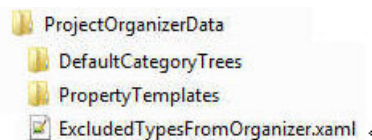

All templates and categories in these folders are loaded to **Organizer** when you open it for the first time in a model. If there are many files with the same file name in several different folders, the first file found is loaded and the other files with the same file name are ignored. The search order is always: model, project, firm, system. The `roles.ini` does not affect this order.

For example, if you have `rebar.category`, `category.category` and `material.category` in a system folder `\ProjectOrganizerData\DefaultCategoryTrees` folder, these files will all be loaded automatically to the categories. If you also have a `rebar.category` file in the `\PROJECT\ProjectOrganizerData\DefaultCategoryTrees` folder and in the `\model\ProjectOrganizerData\DefaultCategoryTrees` folder, only the first `rebar.category` file found is used. In this case, the file under the model folder would be the first one found.

NOTE You can use the `roles.ini` files to control multiple setups. For example, create a `\Concrete\ProjectOrganizerData` folder and a `\Steel\ProjectOrganizerData` folder under the firm folder. Then define in the `roles.ini` file which of these folders is read and/or in which order the folders are read. This way you can read only the `\Concrete` folder files, or read the `\Concrete` folder first. In this case, the files with the same name in the steel folder are ignored.

The loaded templates and categories are saved in the `ProjOrg.db` in the `\ProjectOrganizer` folder under the model folder. When you open **Organizer** for the first time, the `ProjOrg.db` is created and the files are read in from the model, project, firm and system folders. The `ProjOrg.db` database stores all template and category information used in the model. When you make changes to the templates and categories in the folders, they are not automatically updated in `ProjOrg.db`. The database will not read in the template and category `xml` files again, so updates to the files will not be automatically applied.

If you want to apply the changed templates and categories to the `ProjOrg` database, you have two options:

- Delete the old templates and categories in **Organizer** and import the changed templates and categories. We recommend that you use this option.
- Export from **Organizer** all the templates and categories that you want to keep and close the model. Delete the `ProjOrg.db` database from the `\ProjectOrganizer` folder under the model folder, and re-open the model. Import the exported templates and categories back to **Organizer**.

NOTE The second option will reset **Organizer** completely. All data will be lost if not exported.

See also

[Categories in Organizer \(page 35\)](#)

[Import a category to Organizer \(page 66\)](#)

[Import a property template to Organizer \(page 33\)](#)

[Export a category from Organizer \(page 64\)](#)

[Export a property template from Organizer \(page 34\)](#)

Excluding object types from Organizer

Some object types can be excluded from **Organizer**. These object types are listed in the `ExcludedTypesFromOrganizer.xml` file that is by default located in the `\system\ProjectOrganizerData` folder in the Common

environment. The location may vary depending on your environment. Excluded object types are not displayed in **Object Browser** and they are not included in categories, even if you select in the category rules to include a model and all its objects to a category. For example, loads, cuts and fittings are listed in the `ExcludedTypesFromOrganizer.xaml` file and excluded from **Organizer**.

You can modify the `ExcludedTypesFromOrganizer.xaml` file to either include or exclude the object types. Before you modify the file, we recommend that you copy it to the `\ProjectOrganizerData` folder that is under the model folder. You may need to create the `\ProjectOrganizerData` folder as it does not by default exist in the model folder.

For example, to exclude fittings, change the value as follows:

```
<Fitting>true</Fitting> to <Fitting>>false</Fitting>
```

To include fittings again, change the value `false` back to `true`.

To apply the changes, click  in **Categories** to fully synchronize **Organizer** with the model.

NOTE Do not add or remove any lines from the `ExcludedTypesFromOrganizer.xaml` file, otherwise **Organizer** will not be able to use the file.

You can also [customize Organizer by creating a setup \(page 57\)](#) that opens the same templates and categories in all new models. A customized setup is useful if you have templates and categories you want to use in all models.

1.7 Synchronize Organizer with the model

You can synchronize **Organizer** with the model to ensure that the categories are up to date and that **Object Browser** shows the latest object property values from the model. You can also synchronize individual categories or reload the **Object Browser** view.

Synchronization adds [location information \(page 63\)](#) to model object properties. You can use the location information when creating reports and inquiries.

Synchronize Organizer

Synchronizing **Organizer**  updates all properties of the changed objects in the **Organizer** database. You do not need to reload **Object Browser** if you change the selection in the model, or select another category or property

template. When you have synchronized **Organizer**, the object properties are up to date until you make changes in the model.

Organizer is synchronized:

- When you click  **Synchronize with the model..**
- When you open **Organizer** and select to synchronize it.

To make synchronization faster, set the `XS_COLLECT_MODEL_HISTORY` advanced option to `TRUE`. If `XS_COLLECT_MODEL_HISTORY` is set to `FALSE`, at synchronization all objects are loaded to check what has been deleted in the model.

When you synchronize **Organizer**, the Tekla Structures action history that is used in undoing the last action is deleted. This means that you cannot use the **Undo (Ctrl + Z)**  command immediately after you have synchronized. Otherwise, **Undo** works normally.

Note that the **Undo history** list  is cleared when you synchronize **Organizer**. The **Undo history** list shows all the commands that you have run and the modifications that you have made in the model. Saving the model also clears the list.



You can define in **Organizer Settings**  that **Organizer** is always synchronized when you open it. Go to the **Synchronization** tab and select the **Always synchronize Organizer with the model when opening** checkbox.



When you open **Organizer** and select the **Do not show this dialog again.** checkbox in the **Synchronize** dialog, **Organizer** does not show the **Synchronize** dialog anymore in any model where you use **Organizer**. To get the **Synchronize** dialog back, browse to the `\users\\AppData\Local\Trimble` folder and delete all the files starting with `ObjectBrowser`. Note that deleting these files deletes the default **Organizer** unit settings. Check the unit settings in **Organizer Settings**.

Update the whole Organizer database

You can update the whole **Organizer** database so that the properties you have viewed in **Object Browser**, or that are used in categories, are updated to all model objects in the **Organizer** database.

The **Organizer** database is updated:

- When you press **Ctrl +**  **Synchronize with the model.**
- When you open a model that was saved with an older Tekla Structures version and click  **Synchronize with the model.**

- When you select or clear the **Pour units enabled** setting on the **Synchronization** tab in **Organizer Settings**, and then close the **Settings** dialog. The **Pour units enabled** setting controls whether **Organizer** uses pour units or cast-in-place cast units as the highest cast-in-place hierarchy in the categories. To use the **Pour units enabled** setting, set the `XS_ENABLE_POUR_MANAGEMENT` advanced option to `TRUE`.
- When you change any model-specific advanced option and the next time click  **Synchronize with the model**.
- When you save the model with **Save as** and the next time click  **Synchronize with the model**.
- When you change the material catalog and the next time click  **Synchronize with the model**.

Reload Object Browser

Click the  reload button in **Object Browser** when you want to view the latest property values from the model. Once you have viewed a property of any object in **Organizer**, the property will be updated in the **Organizer** database at synchronization.

If you make changes in the model while viewing the objects, reload **Object Browser**.

NOTE When you select objects in the model or in the categories, **Object Browser** shows the properties that are already in the **Organizer** database, and loads the new values from the model to the properties that are not yet in the **Organizer** database.

You have to **Reload the view**  in **Object Browser** to update the view with the new values.

Synchronize a category

Organizer is partially synchronized:

- When you select a category, right-click and select **Synchronize category**.
To view the synchronization date and time, right-click the category again.
- When you synchronize categories at export.

Partial synchronization:

- Synchronizes the whole project when you synchronize any location category, such as a **Floor**.

- Synchronizes the categories that are used in the category rules of other categories when you synchronize these other categories.
- Synchronizes the whole category tree created by automated subcategory rules when you synchronize one subcategory in the tree.
- Synchronizes the whole category tree when you synchronize a manually created subcategory in a property category tree.

NOTE Partial synchronization does not update the properties shown in **Object Browser**. You need to reload  **Object Browser** to show the updated category content.

Exclude a category from synchronization

1. Select a category, right-click and select **Properties**.
2. Clear the **Update category at synchronization** checkbox.

The objects that are deleted from the model are removed from the category even if the **Update category at synchronization** option is not selected.

1.8 Report Organizer location categories

You can use location category properties in reports. If you have more than one project in a model, you need to select which project, including the subcategories in the project, is used in reporting. You can use only one project at a time. You can write the report properties to the model.

Note that to use **Organizer** location categories in reporting, you need to set the `XS_USE_INTEGRATED_BUILDING_HIERARCHIES` advanced option to `FALSE`.

1. To open **Organizer**, click **Manage** on the ribbon and then click **Organizer**.
2. Select a **Project**.
3. Right-click and select **Use for reporting**.

The icon in front of the **Project** that is selected for reporting is shown as black .

4. Right-click the **Project** again and select **Write to the model for reporting**.

The report properties are updated to the model.

The location properties of the assembly level objects in the model are:

- `LBS_PROJECT`
- `LBS_BUILDING`
- `LBS_SECTION`

- LBS_SITE
 - LBS_FLOOR
 - LBS_FLOOR_ELEVATION
 - LBS_HIERARCHY_LEVEL_NUMBER
 - LBS_HIERARCHY
5. To change the project used for reporting, select another **Project**, right-click and select **Use for reporting**.
 6. Right-click the **Project** again, and select **Write to the model for reporting**.

The report properties are updated to the model.

The report properties are also written to the model when you synchronize



Organizer with the model.

NOTE When using location properties in a report template, you need to add `LOCATION_BREAKDOWN_STRUCTURE` to the property name, for example, `LOCATION_BREAKDOWN_STRUCTURE.LBS_FLOOR`.

See also

[Categories in Organizer \(page 35\)](#)

[Synchronize Organizer with the model \(page 60\)](#)

1.9 Export a category from Organizer

You can export categories from **Organizer** to an `xml` format file and use the exported categories in other models. You can export the selected categories, or all location categories, custom categories, and property categories at a time. **Organizer** creates only one `.category` export file even if you export more than one category at a time. By exporting categories you can ensure that you have back-up copies of the categories you have created.

For information on how to use the firm, project and system folders with **Organizer**, see [Customized default setup for Organizer \(page 57\)](#).

1. To open **Organizer**, click **Manage** on the ribbon and then click **Organizer**.
2. Select one or more categories.
3. Click  and select **Export Organizer categories**.
4. Define the export settings.
 - a. Select **All categories** or **Selected categories with their subcategories**.

- Exporting location categories: The whole project is exported even if you only select a subcategory in the project, for example, a floor.
 - Exporting categories that have been created using rules: The whole category tree is exported. If you select a subcategory, the main category and the other subcategories in the category tree are also exported.
 - Exporting property categories: The whole category tree is exported. If you select a subcategory, the main category and the other subcategories in the category tree are also exported.
 - Exporting categories that have been created manually: Only the selected category is exported.
- b. Select the **Include the properties of the categories** checkbox to include category properties in the export.
 - If the rules in category properties include a filter, and you plan to use the category in another model, the filter must be available in that model. Otherwise, the category will not have the correct content.
 - If you do not select **Include the properties of the categories**, only the category name is exported. The property template is set to the default template in the export.
 - c. Select the **Include the objects** checkbox to include the object GUIDs in the export.

If the exported category is used in other models, the categories will be empty.
 - d. Select the **Synchronize the categories before export** checkbox if you want to ensure that the latest model changes are included in the export.
5. Click **Browse** to select the destination folder.

By default, the category is exported to the `\ProjectOrganizer` folder in the current model folder.
 6. Click **Export**.

If the category you are exporting includes other categories in the category property rules, and you have not selected these other categories to the export, the **Export category structure references** dialog is displayed.

 - a. **Export the valid references** exports categories including the rules defined in the category.

This option is dimmed when you have not selected the categories defined in the rules for export. Click **Cancel** and select the category to export and the categories used in the rules. When you do this, the **Export category structure references** dialog is not shown at all. In import, all exported categories will now be imported.

- b. **Export without references** exports the object GUIDs in the categories if you have selected the **Include the objects** checkbox in the **Export category structure** dialog.

If you have not selected to include the objects, only the category name is exported. In import, **Organizer** treats this category as a manually created category.

7. Click **OK**.

See also

[Import a category to Organizer \(page 66\)](#)

[Categories in Organizer \(page 35\)](#)

1.10 Import a category to Organizer

You can import categories that have been exported from **Organizer** in the current model or in other Tekla Structures models. The category import files are in the `xml` format, and have the `.category` file extension. You can import one `.category` file at a time. The file can contain many categories.

For information on how to use the firm, project and system folders with **Organizer**, see [Customized default setup for Organizer \(page 57\)](#).

1. To open **Organizer**, click **Manage** on the ribbon and then click **Organizer**.
2. Click  and select **Import Organizer categories**.
3. Click **Browse**.
4. Select the `.category` file you want to import.
5. Click **Open**.
6. Click **Import**.

If the category you are importing has the same name as an existing category, you have the following options:

- You can import the category and replace the existing category.
- You can select not to import the category.
- You can import the category but keep the existing category. If you import a category that has the same name as an existing category, **Organizer** adds a running number to the category name.

Location categories are added at the end of the location categories, property categories at the end of property categories, and custom categories at the end of the custom categories.

NOTE If the imported category does not contain any objects, check if the rules in the category properties have a filter that does not exist in the model. When you add the filter to the model, the category content is updated. Another reason could be that there are no objects in the model that match the rules.

The category may also be empty if it has only manually added content and the objects were not included in the export. If you have imported the category from another model, the manually added content is not imported.

See also

[Categories created in earlier Tekla Structures versions \(page 67\)](#)

[Export a category from Organizer \(page 64\)](#)

[Categories in Organizer \(page 35\)](#)

Categories created in earlier Tekla Structures versions

If you have used the **Model Organizer** tool in the same model in an earlier Tekla Structures version, the categories created in **Model Organizer** are automatically transferred to **Organizer**. **Model Organizer** categories are shown in the custom categories in **Organizer**.

When you are using **Organizer** in a model created in an earlier Tekla Structures version:

- If you have never opened **Model Organizer** in the earlier Tekla Structures version model, no categories are imported.
- If you have opened and closed **Model Organizer** in the earlier Tekla Structures version model, the project and site logical area categories are imported to **Organizer**.
- If you have added at least one object to the **Model Organizer** logical area categories, the logical area categories are imported to **Organizer**.
- If you have added at least one object to the **Model Organizer** object type categories, all the categories are imported to **Organizer**.

Model Organizer property sets are imported to **Organizer**, converted to property templates, and named after the categories. If several categories have the same name, a running number is added to the property template name.

See also

[Import a category to Organizer \(page 66\)](#)

1.11 Import IFC categories to Organizer

You can import the location breakdown structure of an IFC model as IFC categories to the location categories in **Organizer**.

1. To open **Organizer**, click **Manage** on the ribbon and then click **Organizer**.
2. Select a **Project**, right-click and select **New IFC project**.
3. Select the IFC model.
4. Click **Import**.

The IFC categories are imported at the bottom of location categories. The objects of the imported IFC model are automatically included in the IFC categories.

5. If the IFC model is changed, you can update the latest version of the model to the categories. Select the highest IFC category level in the category tree, right-click and select **Update**.

TIP If you import IFC categories that have the same name as existing IFC categories, **Organizer** adds a running number to the category name. You can rename the categories.

See also

[Categories in Organizer \(page 35\)](#)

1.12 Organizer in the multi-user mode

When using **Organizer** in the multi-user mode, only one user at a time can save changes. The first user who opens **Organizer** becomes the main user and is the only user who can save changes. When the main user closes **Organizer** and saves the model, another user who wants to save changes must first close **Organizer** and open it again to be able to save changes.

If there already is a main user in **Organizer** when another user opens **Organizer**, the other user will get a message that the database is locked and that changes cannot be saved permanently. Note that even though only one user at a time can save changes, other users can still select, create and modify categories and property templates. Other users can export the categories and property templates they have changed, and import them back to **Organizer** for saving.

NOTE **Organizer** data is not shared in Tekla Model Sharing.

See also

[Organizer \(page 7\)](#)

1.13 Example: Organize the model into location and custom categories, and view quantities

This example will go through the basic workflow of setting up **Organizer**, and creating concrete and reinforcing bar take-offs.

You will use **Organizer** to organize your model into buildings, sections and floors based on the locations in the model. You will create a category tree structure and custom categories. When you have created the locations and custom categories, it is fast and easy to view and report quantities in **Object Browser**.

In the example, the set-up is done using the `Cast in Place Sample` model that is available in the **Default** environment as a model template. You can delete the existing set-up or just create a new project and start setting that up.

Example: Organize the model to buildings, sections and floors

You will now organize your model to [location categories \(page 37\)](#).

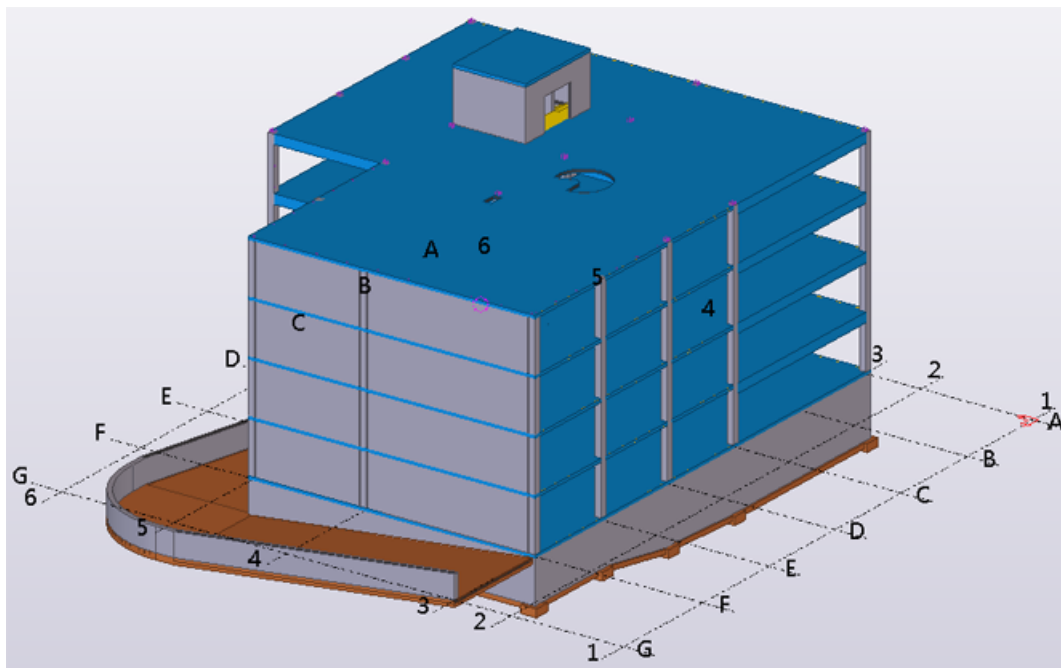

1. To open **Organizer**, click **Manage** on the ribbon and then click **Organizer**.

2. Select the **Building** category under **Project**, right-click and select **Define boundary boxes for locations**.
3. Adjust the boundary box for the building by selecting or entering coordinates.

Boundary boxes for locations ✕

Location definition for "Project > Site > Building" Unit: Millimeter (mm)

Building
Sections
Floors
Settings
▼

Grid origin in the model (0,0, 0,0, 0,0) Rotation 0°

Building name	Local X Axis	Local Y Axis	Local Z Axis
<div style="display: flex; align-items: center;"> 📦 <div style="border: 1px solid #ccc; padding: 5px; flex-grow: 1;">Building</div> </div>	1 (0,0) ▼	-500,0 ▼	-5 000,0 ▼
	6 (36 000,0) ▼	G (37 200,0) ▼	+17400 (17 400) ▼

Modify
Close

4. Go to the **Sections** tab and add two sections to your building using the values shown in the image below.

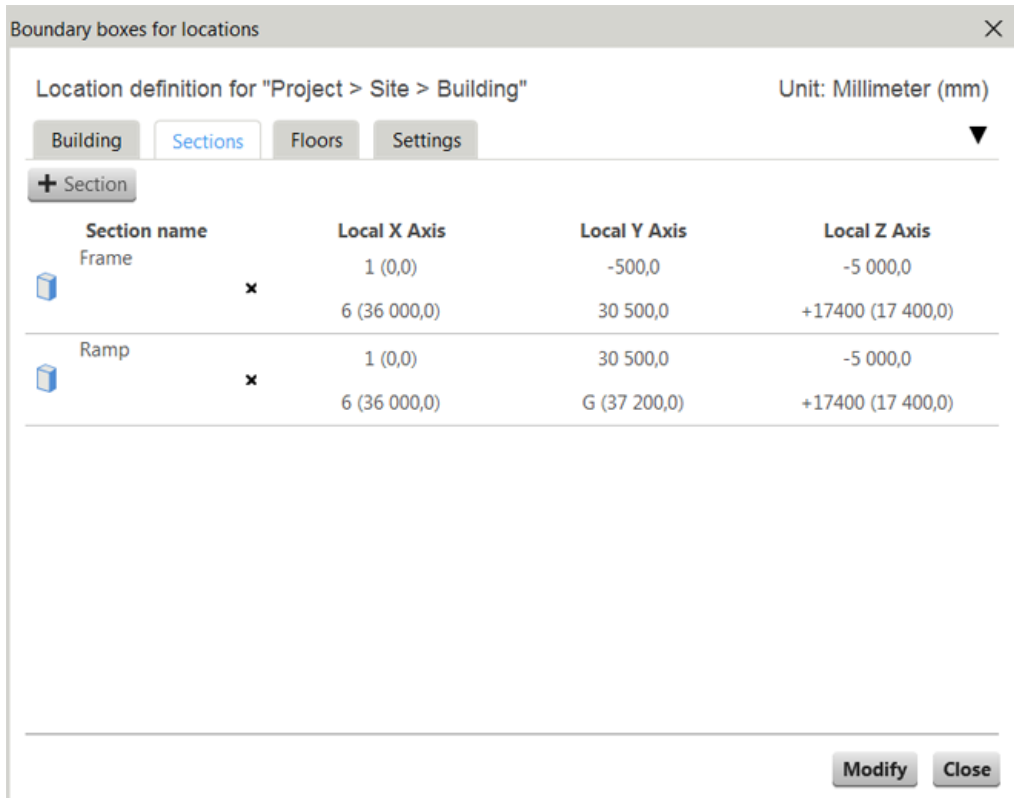

You can click the blue box in front of the section name to visualize the section in the model. The image below shows the **Frame** section.

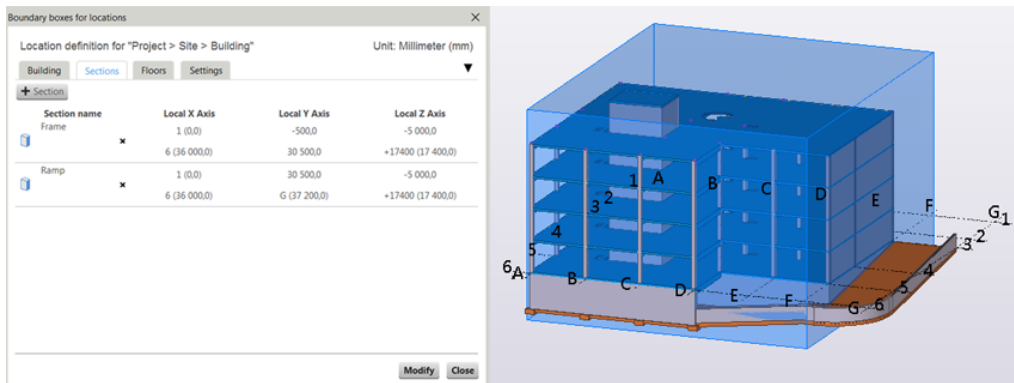

5. Go to the **Floors** tab and create a floor system for the **Frame** section based on the grid lines.

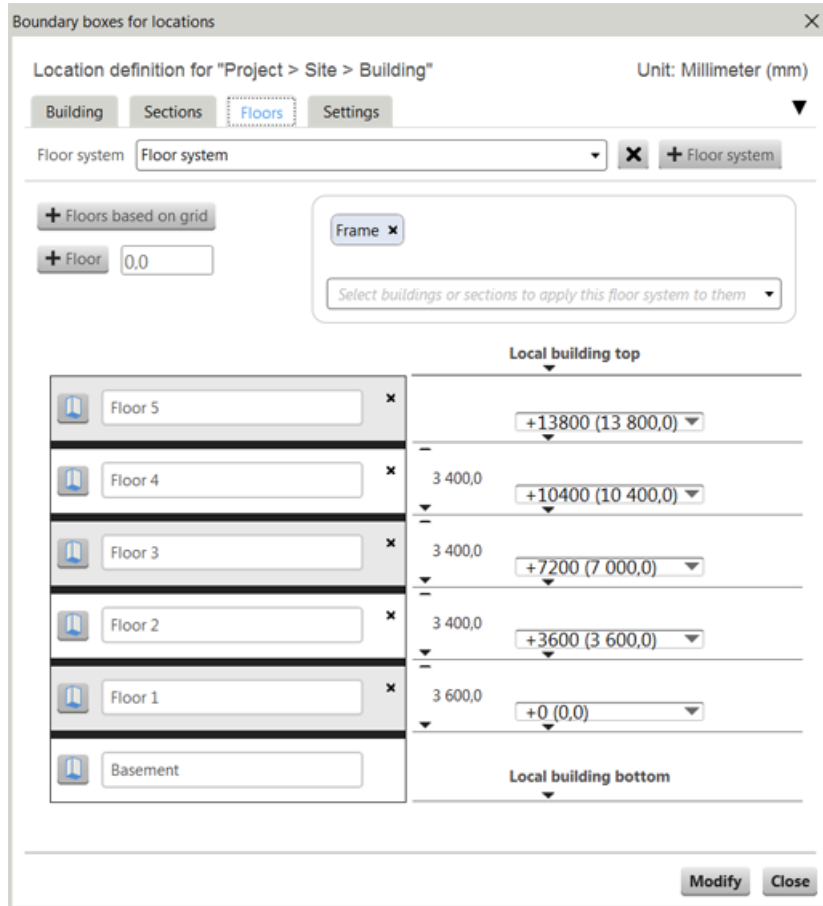

6. Click **Modify** and **Close**.
You have now organized the model to sections and floors based on locations.
7. There are three ramp objects that are located in the **Basement** of the **Frame** section. You have to move these manually to the **Ramp** section:
 - a. Select the **Basement** category, right-click and select **Select in the model** to view the objects in the model.

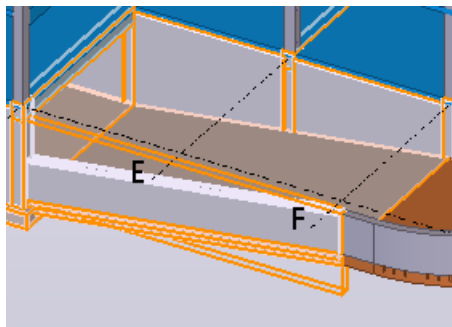

- b. Select the three ramp objects in the model.
- c. Right-click the **Ramp** category and select **Move the selected objects**.

Example: Create a custom category with automated subcategories based on object names in Organizer

You will now [create a custom category \(page 47\)](#) for assemblies, and divide the category to subcategories based on the assembly name.

1. Click  to create a new custom category.
2. Right-click the **Custom Category** and select **Properties**. Rename the category as **Object**.
3. Under **Automated object content**, add the material filters `Material - Concrete` and `Material - Steel` to the rules. You can also select the Tekla Structures model to include the Tekla Structures objects in the category content.

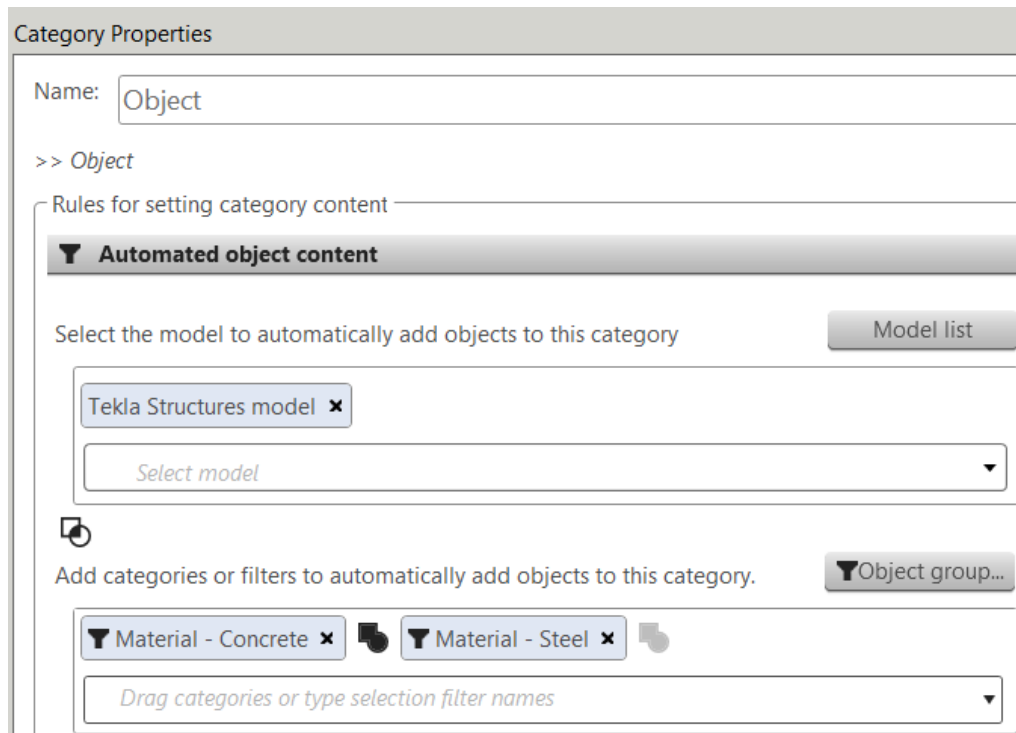

Category Properties

Name:

>> Object

Rules for setting category content

Automated object content

Select the model to automatically add objects to this category Model list



Add categories or filters to automatically add objects to this category. Object group...

4. Click **Modify** to add the objects to the category.
5. Next, group the objects in **Object Browser**. Click  and select **Group** to create a grouping based on the **Name** column. The grouping you see in **Object Browser** is a preview of the automated subcategories.

Content type	Material type	Material	Position number	Profile	Top level / mm	Height / mm	Length / mm	Width / mm	
▶ Name: ANCHOR BOLT (121)							6 236		
▶ Name: BEAM (114)							1 139 680		
▶ Name: COLUMN (190)							648 400		
▶ Name: ELEVATED SLAB (10)							280 000	200	
▶ Name: EMBED (406)							81 694		
▶ Name: FASTENER (288)							14 400	50	
▶ Name: FOOTING (46)							315 896		
▶ Name: GROUND SLAB (14)							189 294		
▶ Name: PAD FOOTING (38)							19 000		
▶ Name: STAIR (6)							19 200	3 200	
▶ Name: STAIRCASE SLAB (34)							109 610		
▶ Name: STAIRCASE WALL (50)							112 500	150	
Number of objects in the table: 1449							Result of: Total	Of these rows: All	
									3 714 707

6. Now create automated subcategories for the category based on object names. Right-click the new category, select **Properties** and under **Automated subcategories**, click **Grouping in Object Browser**. This adds the object properties that are used in the grouping to the category properties.
7. Select the **Include the highest assembly level in the model** checkbox.
Selecting **Include the highest assembly level in the model** ensures that only assemblies and cast units are included in the category. Otherwise, the category will include both parts and assemblies. Using assemblies in categories is important because later you will select and view multiple different categories, and this will require using hierarchical dependencies for objects. Also, **Organizer** is built to work with assemblies.
8. Select the **Default** property template for **Object Browser**.
9. Click **Modify**.

The subcategories are created under the **Object** category. If you now make changes to the model, the category and the subcategories will be updated. For

example, new subcategories are created and old ones deleted based on the names found in the model.

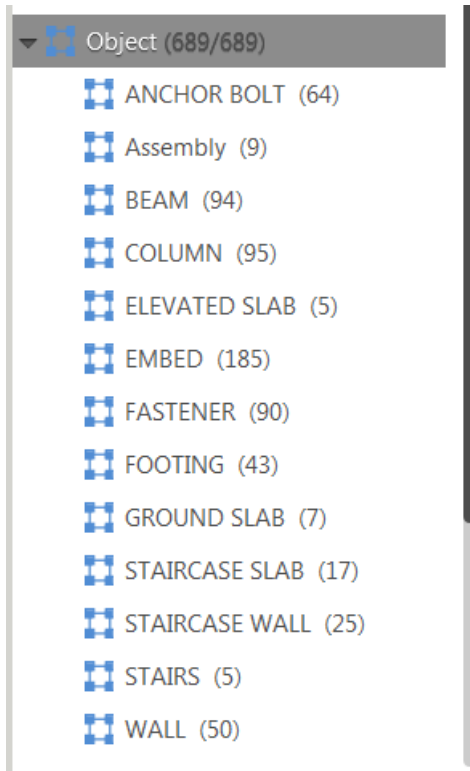

Next, you will create a custom category for reinforcing bars.

Example: Create a custom category for reinforcing bars in Organizer

You will now create [a custom category \(page 47\)](#) for reinforcing bars.

1. Create a new category and name it **Reinforcement**. Select to use the `Object type - Reinforcement` filter in the category property rules.

If you do not have a filter for reinforcement, click **Object group** and create a filter as shown in the image below.

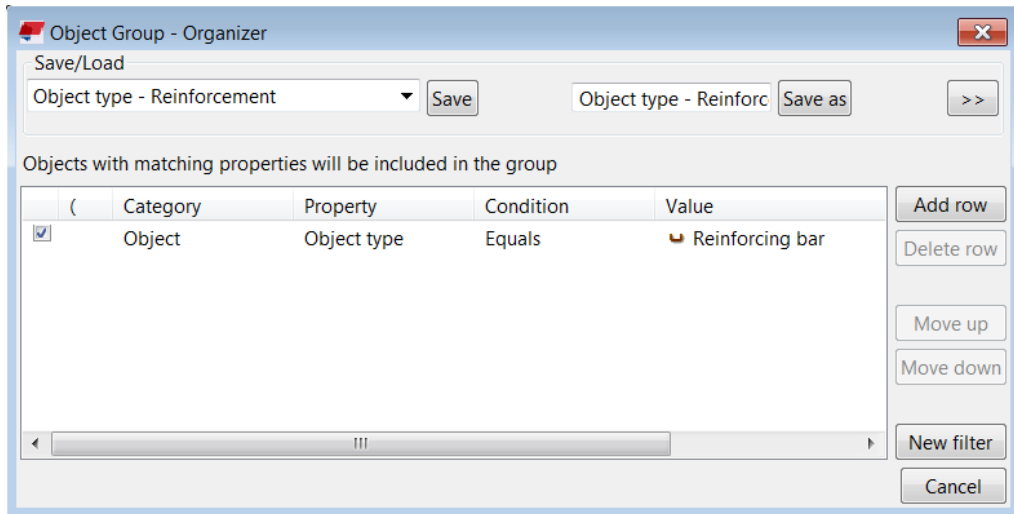

2. Select a property template for **Object Browser**. In this example, you select the **Rebar** template. For this category, do not select the **Include the highest assembly level in the model** checkbox. If you select to include only assemblies, you will get all assemblies that contain reinforcing bars. The highest assembly level for reinforcing bars is cast unit. Create subcategories based on the nominal diameter.
3. Click **Modify** to create the category.

You have now created the categories you need and you can start creating reports.

Next, you will create a concrete quantity take-off and a reinforcing bar quantity take-off for specific objects in a specific location.

NOTE You can customize **Categories** to open with a set of default categories to avoid creating frequently used categories for each project. [Export the desired categories \(page 64\)](#) in the xml format as a .category file. Save the file to your firm folder under \ProjectOrganizerData.

Example: Create a concrete quantity take-off using Organizer

You will now [get the quantities \(page 8\)](#) and formwork areas for the columns on the first floor. You need accurate quantities to order materials (formwork plywood and concrete), or just to plan your work.

1. Select the **Floor 1** and **Column** categories in the category tree.
2. Select a property template for quantity take-offs. **Object Browser** now shows the quantities of the columns on the first floor.

Organizer

Object Browser

Quantity takeoff Modify Show from model Show from Categor

Name ▲	Grid position	Material	Profile	Length / mm	Volume / m3	Top level / mm	Section	Floor
COLUMN	3/F	C30/37	400*40	3 200,0	0,5	3 400,0	Frame	Floor 1
COLUMN	4/F	C30/37	400*40	3 200,0	0,5	3 400,0	Frame	Floor 1
COLUMN	5/F	C30/37	400*40	3 200,0	0,5	3 400,0	Frame	Floor 1
COLUMN	5/E	C30/37	400*40	2 816,6	0,4	3 016,6	Frame	Floor 1
COLUMN	3/E	C30/37	400*40	2 800,0	0,4	3 000,0	Frame	Floor 1
COLUMN	3/D	C30/37	400*40	2 800,0	0,4	3 000,0	Frame	Floor 1
COLUMN	3/C	C30/37	400*40	2 800,0	0,4	3 000,0	Frame	Floor 1
COLUMN	3/A	C30/37	400*40	2 800,0	0,4	3 000,0	Frame	Floor 1
COLUMN	4/A	C30/37	400*40	2 800,0	0,4	3 000,0	Frame	Floor 1
COLUMN	5/A	C30/37	400*40	2 800,0	0,4	3 000,0	Frame	Floor 1
COLUMN	6/A	C30/37	400*40	2 816,6	0,4	3 016,6	Frame	Floor 1
COLUMN	6/B	C30/37	400*40	2 816,6	0,4	3 016,6	Frame	Floor 1
COLUMN	6/C	C30/37	400*40	2 816,6	0,4	3 016,6	Frame	Floor 1
COLUMN	6/D	C30/37	400*40	2 816,6	0,4	3 016,6	Frame	Floor 1
COLUMN	5/D	C30/37	400*40	2 816,6	0,4	3 016,6	Frame	Floor 1
COLUMN	4/E	C30/37	400*40	2 800,0	0,4	3 000,0	Frame	Floor 1
COLUMN	4/D	C30/37	400*40	2 800,0	0,4	3 000,0	Frame	Floor 1
COLUMN	4/C	C30/37	400*40	2 800,0	0,4	3 000,0	Frame	Floor 1
COLUMN	4/B	C30/37	400*40	2 800,0	0,4	3 000,0	Frame	Floor 1

Number of objects in the table: 19 Result of: Total Of these rows: All

				54 499,5	8,7			
--	--	--	--	----------	-----	--	--	--

In this example, you have 19 columns with a total volume of 8.7 m³. You can now create a report by exporting, or you can just check the objects individually. Or, you can just use the total volume and call the concrete supplier to order the needed concrete to the site.

3. Select a property template for formwork. Using a different property template allows you to get different information on your selection.

Organizer

Object Browser

Formwork columns, walls and footings Modify Show from model Show from Ca

Name	Grid position	Formwork area / m2	Section	Floor
COLUMN	3/F	5,1	Frame	Floor 1
COLUMN	4/F	5,1	Frame	Floor 1
COLUMN	5/F	5,2	Frame	Floor 1
COLUMN	5/E	4,7	Frame	Floor 1
COLUMN	3/E	4,5	Frame	Floor 1
COLUMN	3/D	4,5	Frame	Floor 1
COLUMN	3/C	4,5	Frame	Floor 1
COLUMN	3/A	4,5	Frame	Floor 1
COLUMN	4/A	4,5	Frame	Floor 1
COLUMN	5/A	4,5	Frame	Floor 1
COLUMN	6/A	4,7	Frame	Floor 1
COLUMN	6/B	4,7	Frame	Floor 1
COLUMN	6/C	4,7	Frame	Floor 1
COLUMN	6/D	4,7	Frame	Floor 1
COLUMN	5/D	4,7	Frame	Floor 1
COLUMN	4/E	4,5	Frame	Floor 1
COLUMN	4/D	4,5	Frame	Floor 1
COLUMN	4/C	4,5	Frame	Floor 1
COLUMN	4/B	4,5	Frame	Floor 1

Number of objects in the table: 19 Result of: Total Of these rows: All

88,4

You now get the total formwork area for columns. The formwork area is calculated using a [formula \(page 30\)](#). You can also see the individual formwork area of each column.

4. To check for discrepancies, you can select columns and locate them in the model for visual checking:
 - a. Select the columns in **Objects Browser**.
 - b. Right-click on the selected rows and select **Select in the model**.
 - c. Press **Ctrl+5** to show only the selected columns. Other objects are almost completely transparent.
 - d. Press **Ctrl+4** to show the object surfaces again.

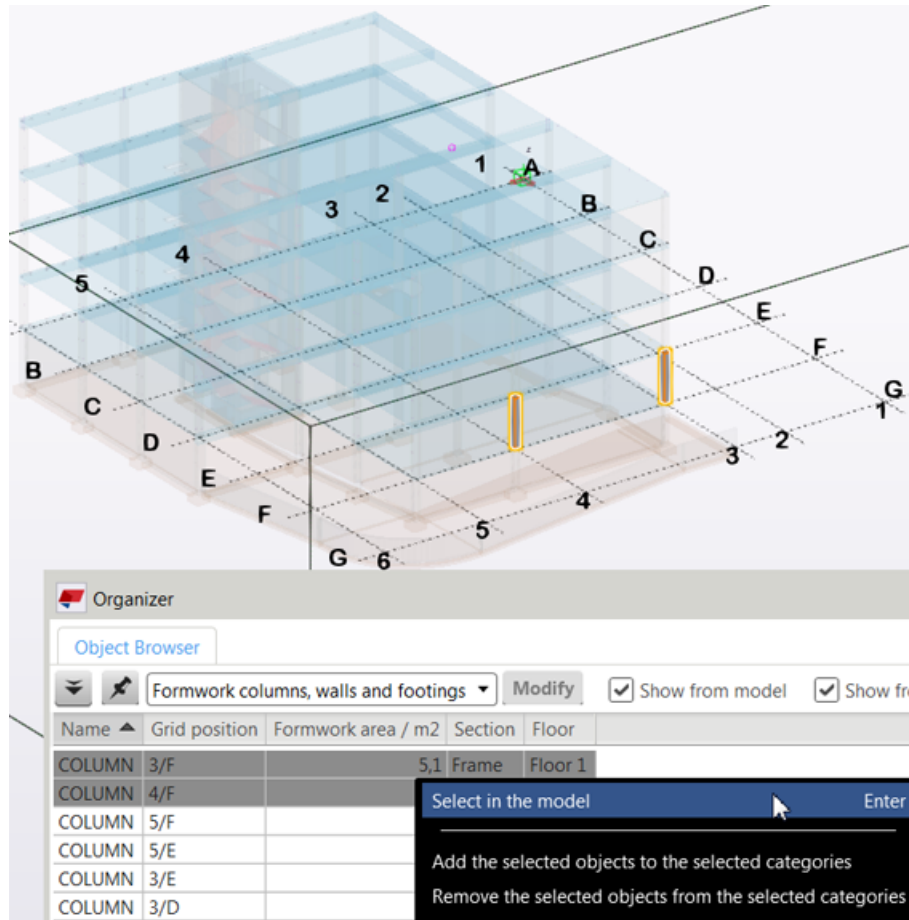

Next, you will create a quantity take-off for the reinforcing bars in the first floor columns.

Example: Create a reinforcing bar quantity take-off using Organizer

You will now [get the quantities \(page 8\)](#) of the reinforcing bars of the columns on the first floor.

1. Select the **Floor 1** and **Reinforcement** categories, and the **Column** subcategory.
2. Click  to view the categories as unions and intersections in the selection pane, as shown in the image below. In this example, you need the intersections of the categories.

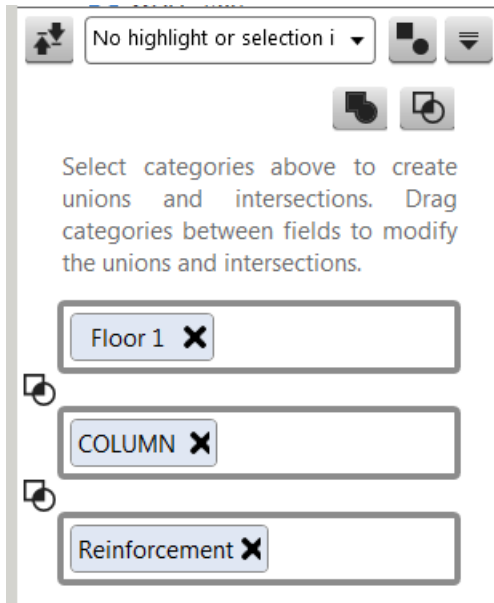

Object Browser shows the reinforcing bars that belong to the columns on **Floor 1** using a combination of the property templates of all the selected categories. You can select a different property template to view other properties, and change the grouping and sorting of the properties.

Name	Content type	Material type	Material	Position number	Profile	Top level / m	Height / mm	Length / mm	Width
▶ Size: 8.0 (57)								81 510,0	
▶ Size: 25.0 (76)								303 000,0	
Number of objects in the table: 133								Result of: Total	Of these rows: All
								384 510,0	

You can change your category selection for different union and intersection combinations. For example, you can add more than one floor category to get a union of the categories.

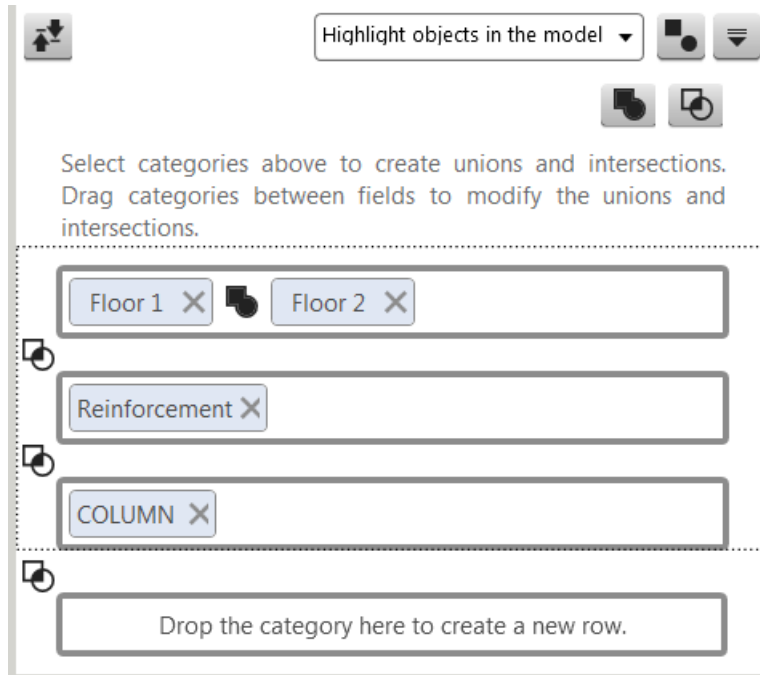

3. Click **Export**  to [create an Excel file \(page 64\)](#) of your selection.

If you need the same report often, you can save your selection as a new category and set the desired template as the default property template. You can use categories in the rules to define the content of the new category. This is useful especially when you are building your model, and want to automatically include model changes in the category.

1.14 Example: Track modeling and planning issues using Organizer

You can use **Organizer** to highlight objects with certain properties. This functionality is useful for detailers and contractors, or anyone who wants to check abnormalities during modeling or planning.

Example: Track reinforcing bar length using Organizer

In this example, the maximum reinforcing bar length in your stock is 12 meters. All the reinforcing bars in your model should therefore be under 12 meters. You can use **Organizer** to track reinforcing bars that are longer than 12 meters.

1. Create a new category and name it **Rebar length over 12 m** in **Category Properties**. Click **Object group** to create a filter for the category and set it up as shown in the image below. The value is shown in millimeters.

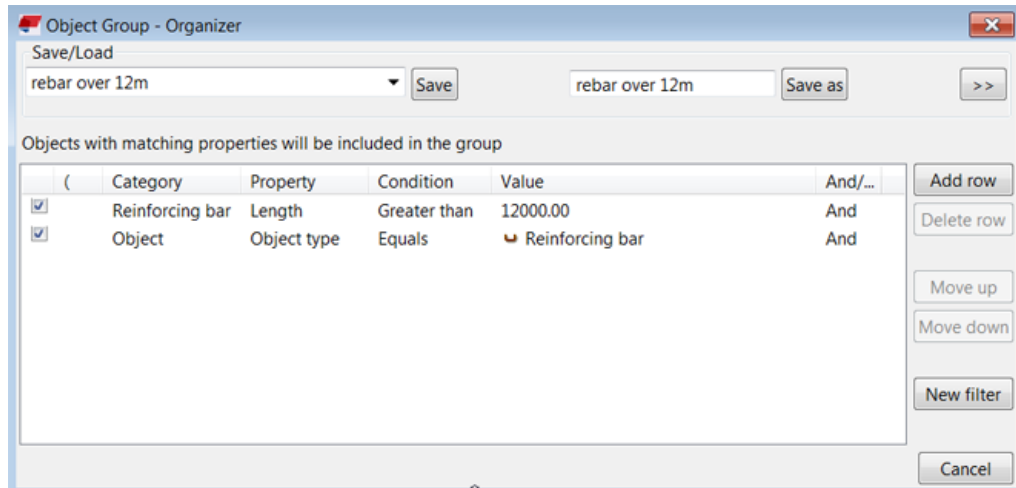

2. Save the filter with a unique name using **Save as**.
3. In **Category Properties**, add the filter you created to the rule box, and an **Object Browser** property template if needed. Note that if you select the **Include the highest assembly level in the model** checkbox, you will get the assemblies and cast units that contain reinforcing bars longer than 12 meters.
4. Click **Modify**. The reinforcing bars that are longer than 12 meters are now included in the category. In this example, there are 208 reinforcing bars longer than 12 meters.
5. Select the category and view the content in **Object Browser**. You can group the reinforcing bars in the category based on their length or location, for example. You can also select them in the model through category, or select them in the **Object Browser** listing and right-click to select them in the model.

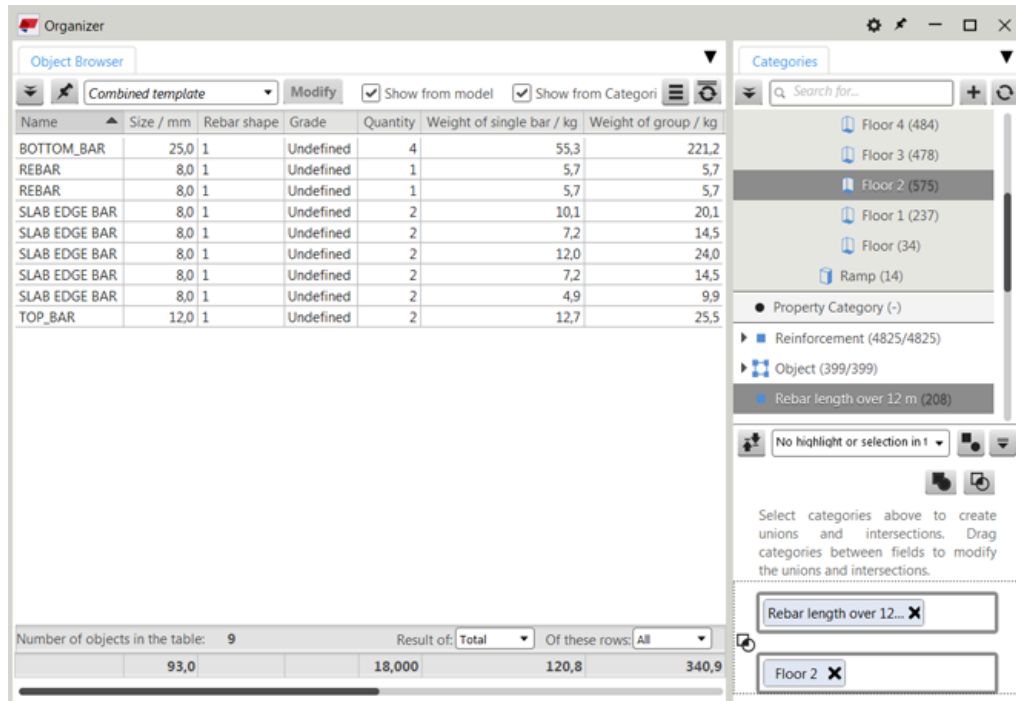

Other possible use cases

You can also check reference models that contain reinforcing bars. In this example, the IFC model has been created with Tekla Structures.

1. First, create a filter as shown in the image below. Click  to set the filter type to **Organizer**.
2. Then, create a new category using this filter.
3. Ensure that your reference model is subdivided to be able to include reference objects to categories.

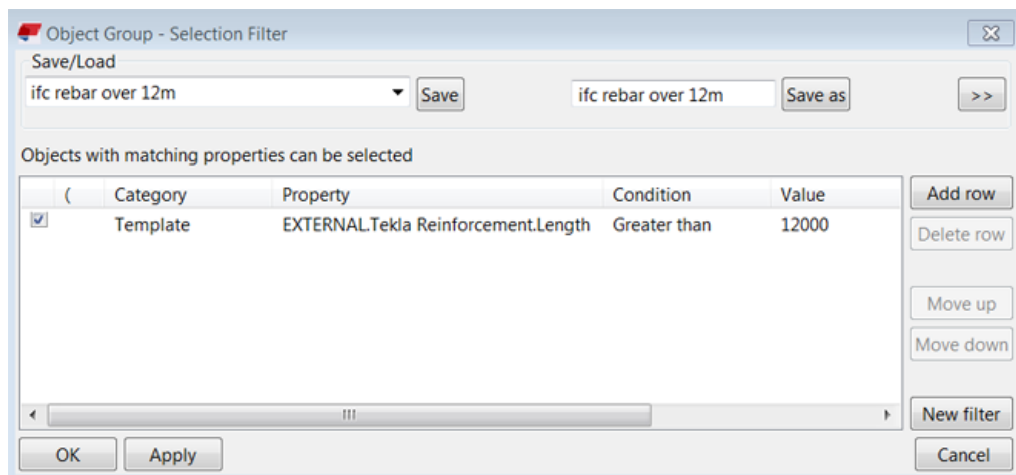

TIP If you have a reference model that has been created with some other software, an easy way to find out the string for the filter is to use the **Inquire** command. Select an object and right-click. Find the desired value string from the **Inquire** dialog, and copy and paste the value as a property to the filter dialog, and add `EXTERNAL.` in front of the property name.

Example: Track too heavy precast elements from a reference model using Organizer

You can track precast element weights in **Organizer** by creating selection filters.

1. Create a new category.
2. Create filters to track precast element weights.
 - a. Create a filter to track a weight over 10 tonnes.

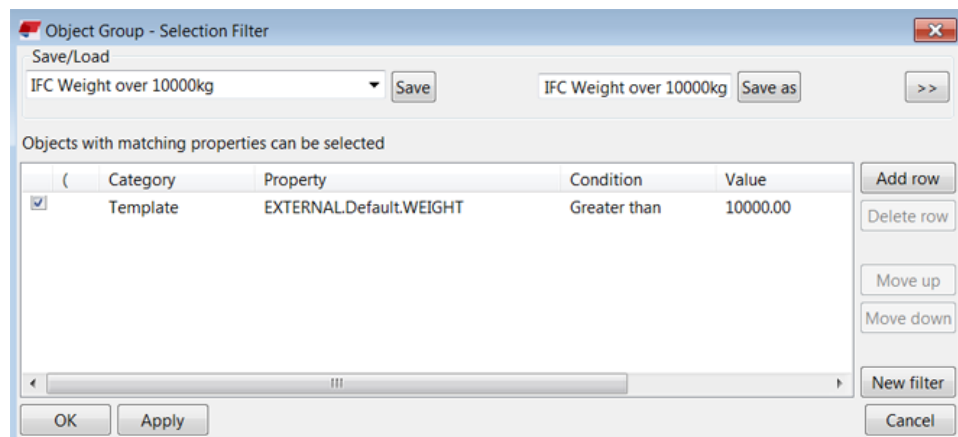

- b. Create a filter to track a weight under 1 tonne.

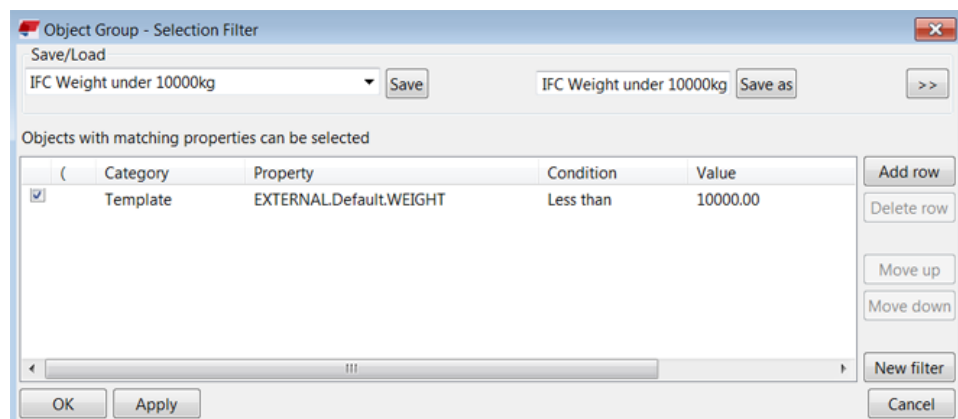

- c. Create a filter to track a weight within a certain limit.

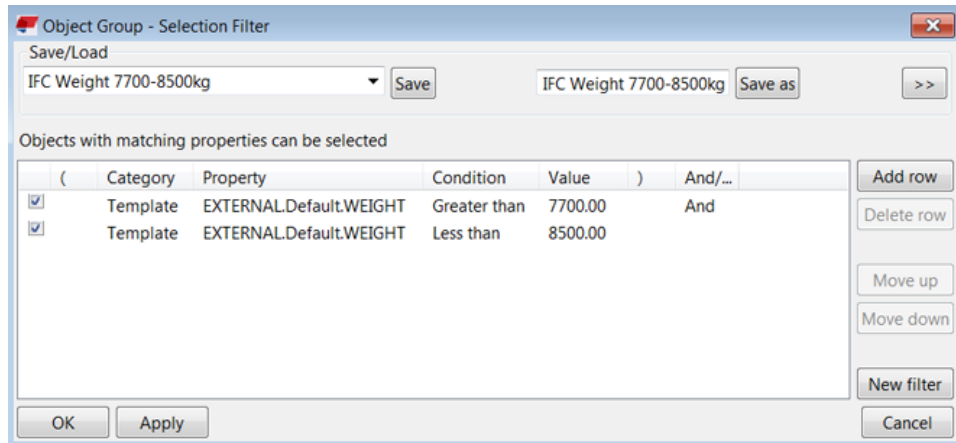

- When you have created the category and the filters, add a suitable filter to the category property rules and save the category.

NOTE You can also use this similar process with Tekla Structures objects, for example, to track both steel assembly and cast unit weights with one filter. Here is an example of such a filter:

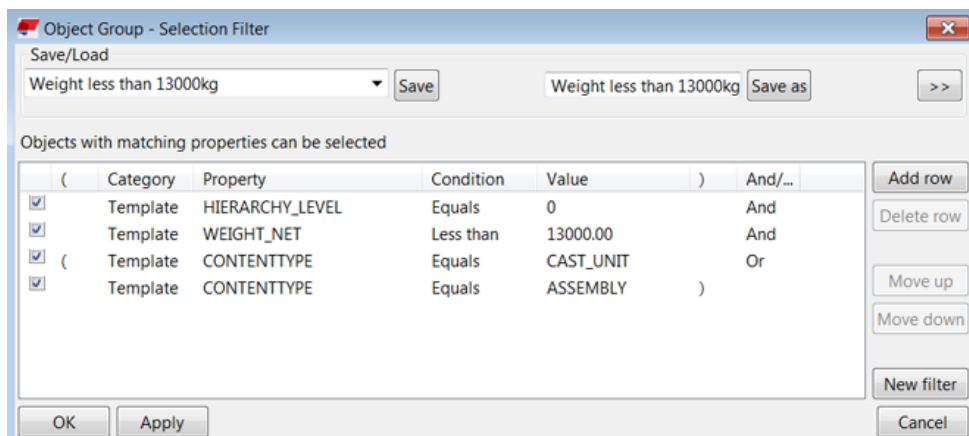

This filter selects all steel assemblies and concrete cast units that are under 13 tonnes. The hierarchy level attribute is needed to get the main assembly weight.

Example: Create weight group categories to track different weights using Organizer

You can create selection filters to track different weights in **Organizer**.

- Create a suitable filter to create categories for weights, for example, Weight 5 - 10t as shown in the image below. Click  to set the filter type to **Organizer**.

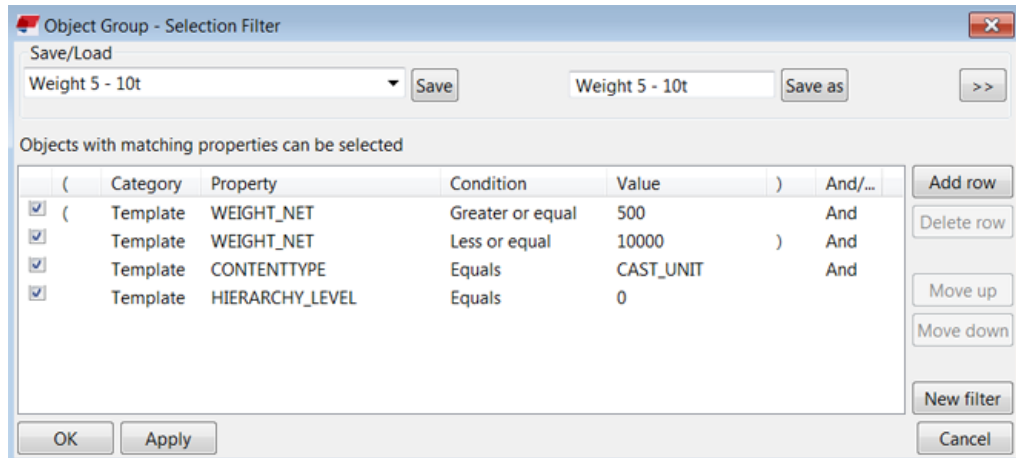

2. You can now create categories for the weight intervals and track locations. You can use the categories like other categories, for example, you could track first floor weights. You can also use the same logic with other properties, such as volume, length, and area. Adjust the filter rules depending on what you want to track.



Example: Track large concrete volumes using Organizer

It may sometimes happen that the volumes in the model accidentally exceed certain limits. Such limits could be the daily pour rate and delivery rate. You can use **Organizer** to track the limits.

1. Create a new category and name the category as **Pour volume over 140m³**.
2. In **Category Properties**, click **Object group** to create a filter for selecting volumes larger than the daily delivery maximum and set it up as shown in the image below. In this example, the daily delivery limit is 140 m³. The unit is mm³.

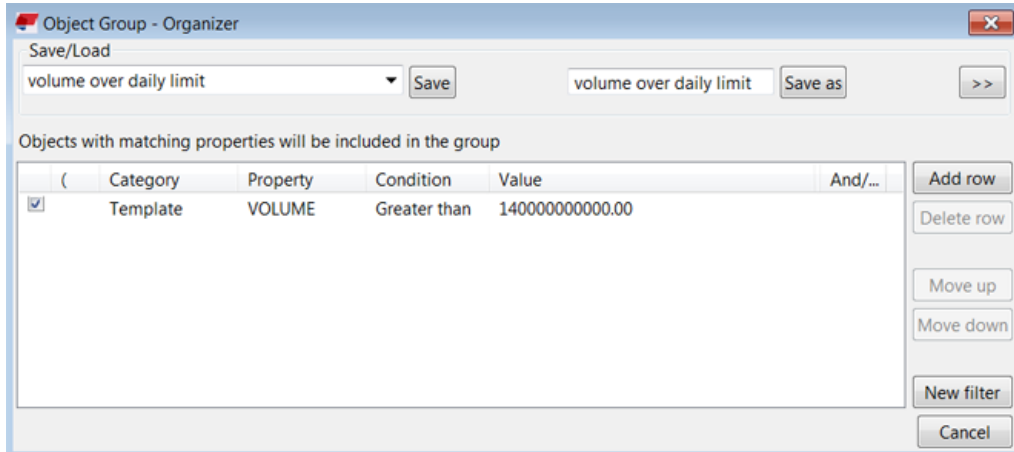

3. Add the filter you created in the category rules and select the **Include the highest assembly level in the model** checkbox. Save the category properties.

Note that if you are doing this with pour objects as shown in the image below, use a pour object filter and do not select the **Include the highest assembly level in the model** checkbox.

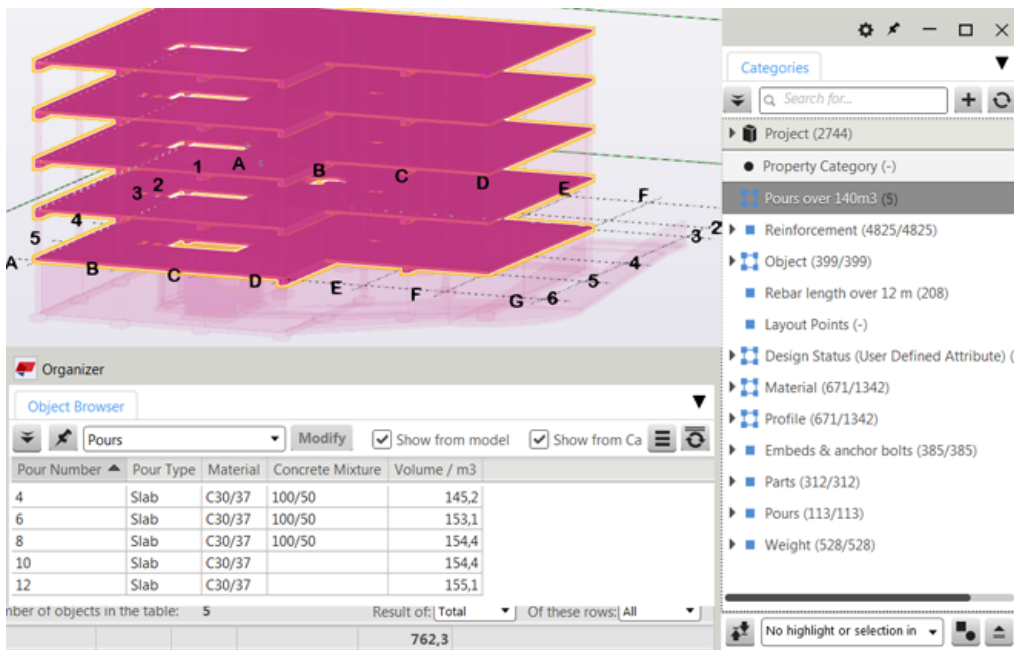

You can now start planning based on the result. For example, you may need a bigger crane, or maybe the elements should be smaller. Perhaps the four pours you have should be divided into smaller pours, or maybe you need more concrete delivered to the site.

1.15 Example: Report areas based on object groups in Organizer

In this example, you will use property categories to create a report on different area calculations for the selected object groups.

First you will create property categories to define the group of objects that need different area calculations. Then you will create formulas for the area calculations, and finally you will add the formulas to the corresponding categories to write the formula results to the model objects. As a result, the objects in the different categories will have different area values in the report.

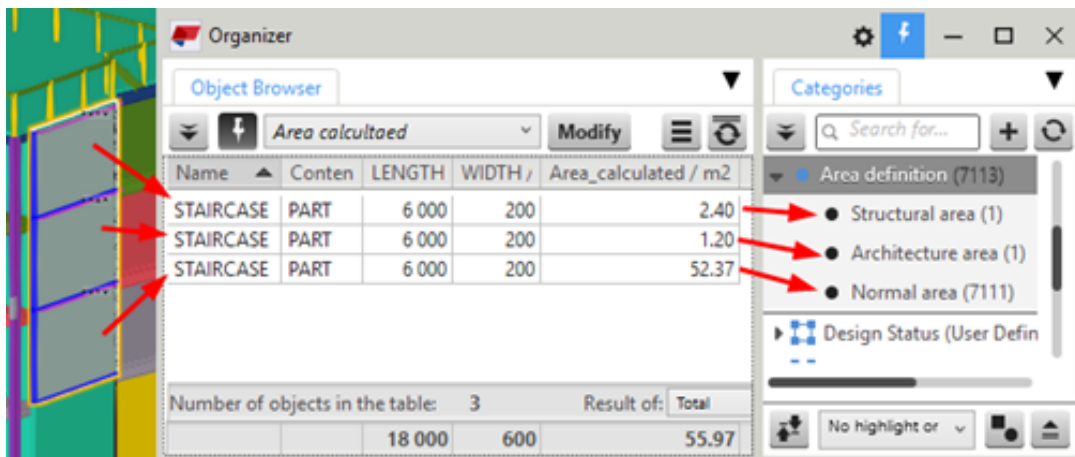

1. To open **Organizer**, click **Manage** on the ribbon and then click **Organizer**.
2. Create a [property category \(page 43\)](#).

Add all model objects to the property category, and create subcategories for the different area calculations you need. You can use object 

or assembly  type of categories according to your needs. To use assemblies, select the **Include the highest assembly level in the model** option in the category properties.

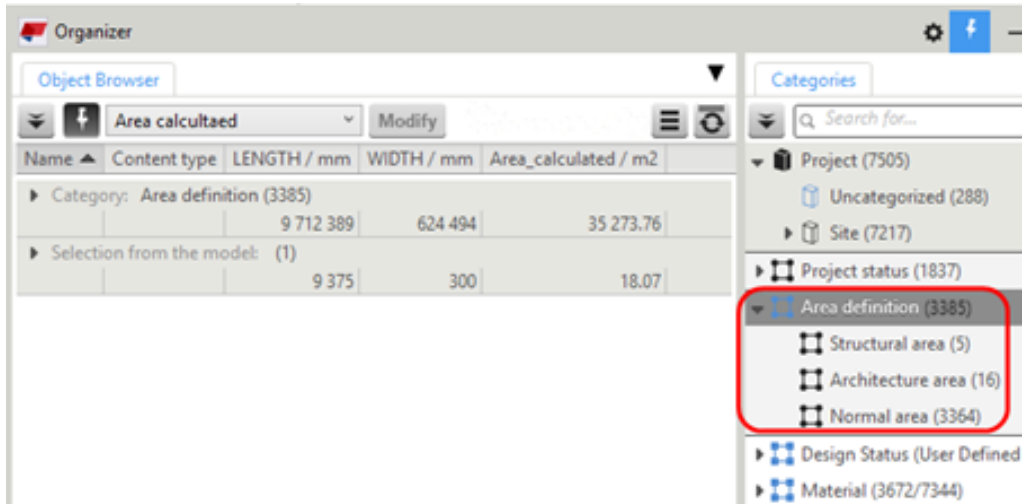

3. [Create a property \(page 28\)](#) to report the calculated areas.

Open the **Settings** dialog in **Organizer**,

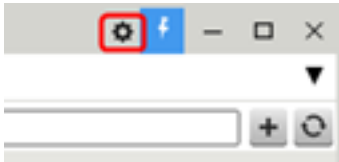

and create the property using the following settings:

- **Name:** Area_calculated
- **Property:** Area_calculated
- **Unit type:** Area
- **Data type:** Number with decimals
- **Property type:** UDA

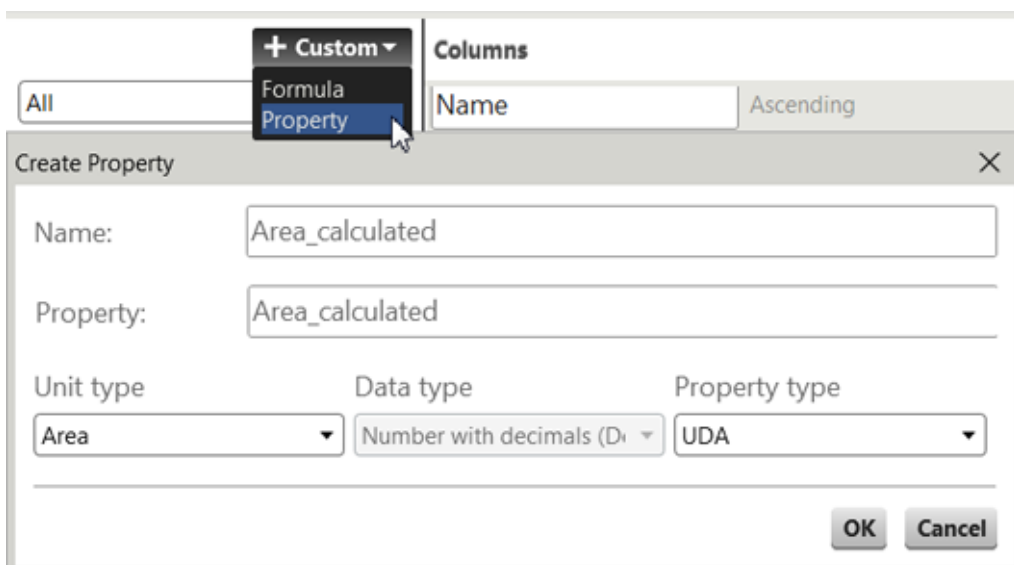

4. Add the property to the property template you are using to show it as a column in **Object Browser**, and click **Modify**.

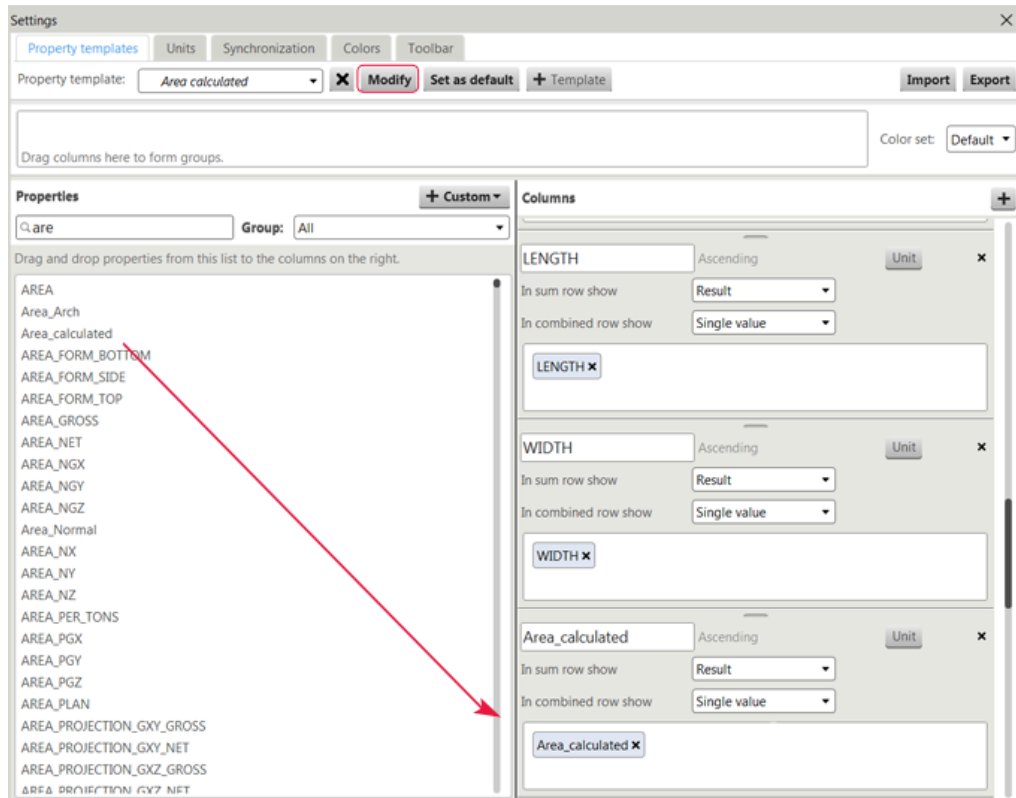

5. [Create separate formulas \(page 30\)](#) for the categories.

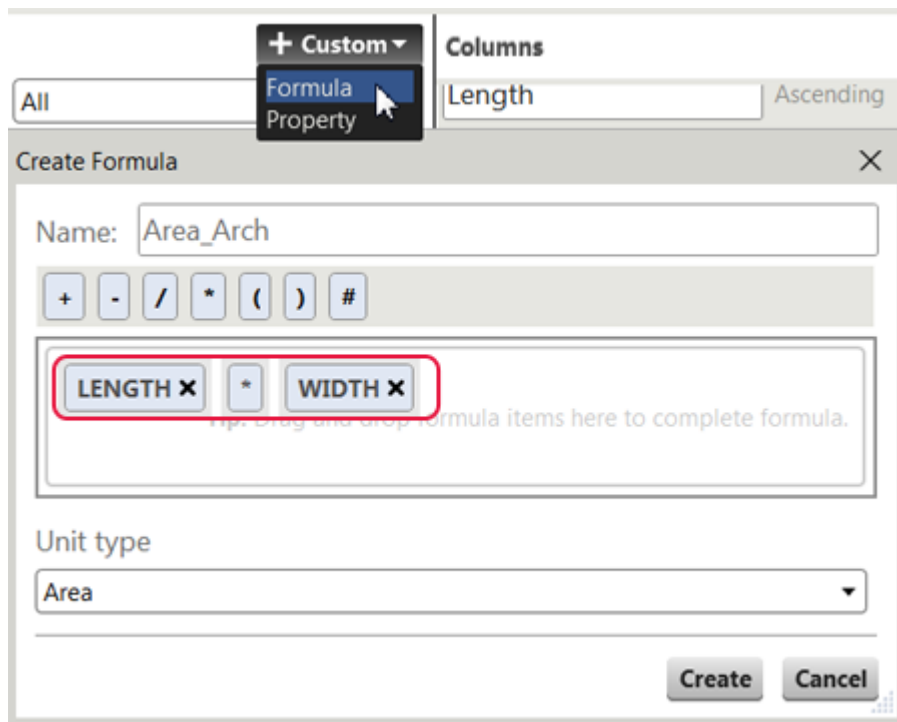

Create Formula ✕

Name:

+ - / * () #

WIDTH ✕ * LENGTH ✕ * 2 ✕

Tip: Drag and drop formula items here to complete formula.

Unit type
Area

Create Cancel

Create Formula ✕

Name:

+ - / * () #

AREA ✕

Tip: Drag and drop formula items here to complete formula.

Unit type
Area

Create Cancel

6. Add the property and the formulas you created to the **Area definition** categories to write the UDA values to the model objects.
 - a. Add the `Area_calculated` property in the category properties of the root-level **Area definition** category.

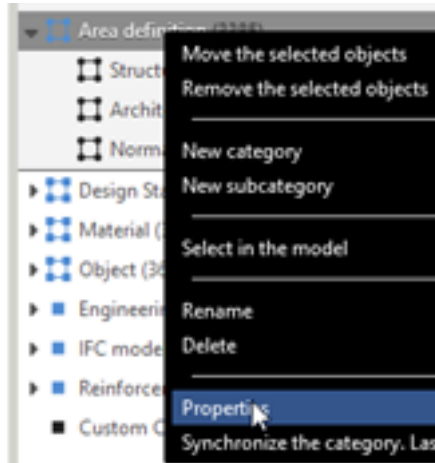

Search for the property in **Object properties**, select it, and click **Modify**.

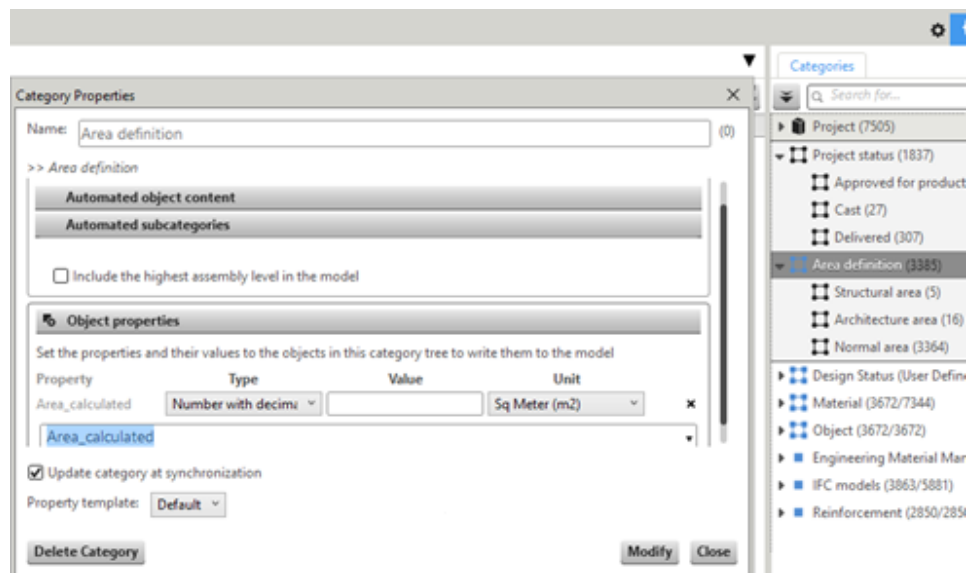

- b. Add a value to the property in the category properties of each lowest-level subcategory.

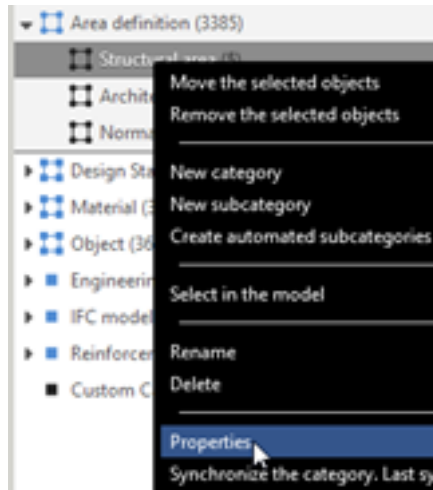

- **Type:** Formula
- **Value:** Select a formula you previously created.

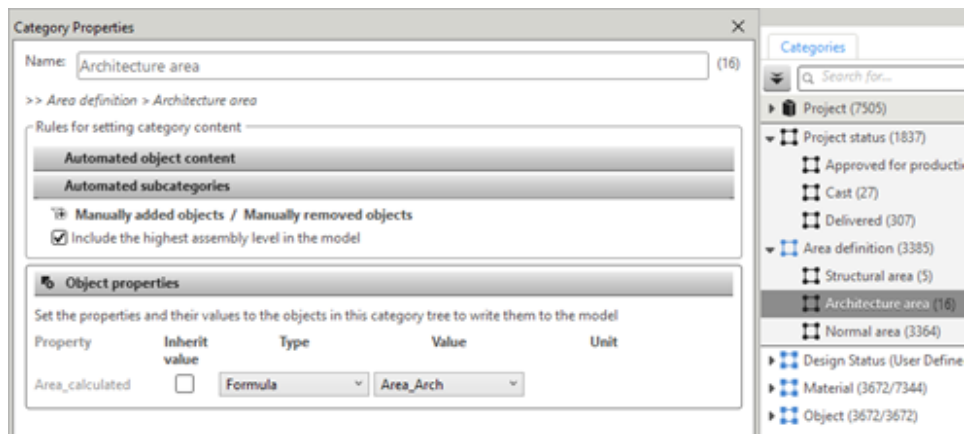
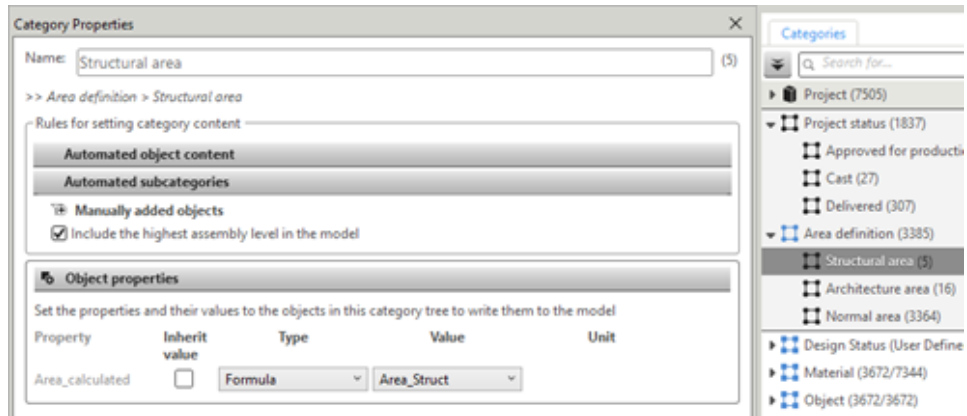

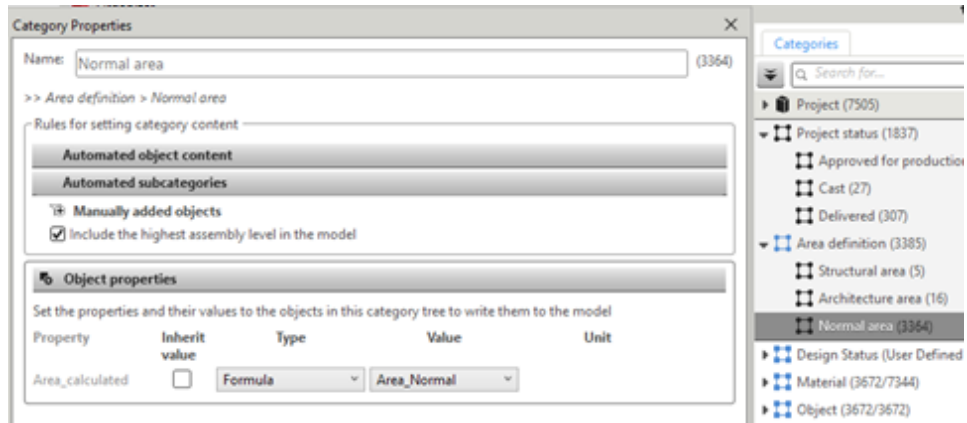

7. Synchronize **Organizer** to calculate the new UDA values and write them to the model objects.

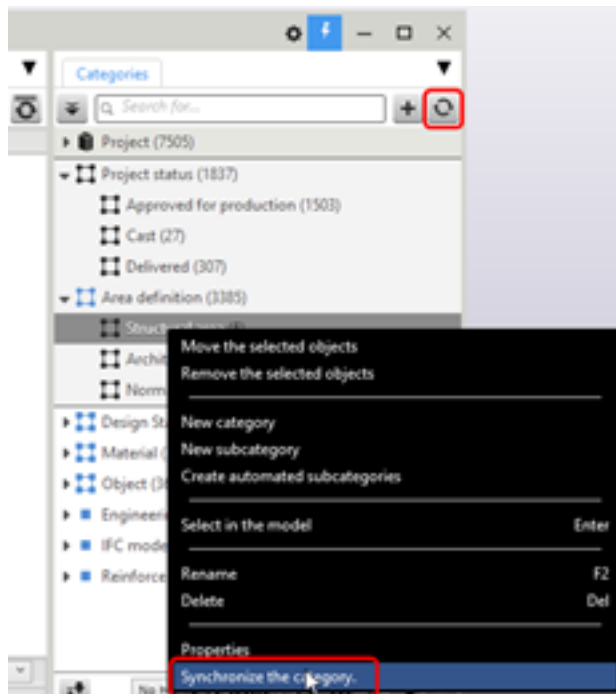

8. View the report in **Object Browser**.

The **Area_calculated** column in **Object Browser** shows the areas of the objects according to the categories they belong to.

Name	Content type	LENGTH / mm	WIDTH / mm	Area_calculated / m2
Category: Area definition > Structural area (5)		24 424	5 345	63.65
STAIRCASE	CAST_UNIT	4 470	200	1.79
STAIRCASE	CAST_UNIT	4 642	200	1.86
STAIRCASE	CAST_UNIT	4 470	200	1.79
STAIRCASE	CAST_UNIT	4 642	200	1.86
STAIRCASE A	CAST_UNIT	6 200	4 545	56.36
Category: Area definition > Architecture area (16)		241 904	14 378	186.73
PANEL	CAST_UNIT	8 056	600	4.83
PANEL	CAST_UNIT	1 088	600	0.65
PANEL	CAST_UNIT	30 344	600	18.21
PANEL	CAST_UNIT	2 046	600	1.23
PANEL	CAST_UNIT	6 385	600	3.83
PANEL	CAST_UNIT	17 819	600	10.69
PANEL	CAST_UNIT	7 042	600	4.23
PANEL	CAST_UNIT	62 540	600	37.52
PANEL	CAST_UNIT	7 700	600	4.62
PANEL	CAST_UNIT	1 976	600	1.19
PANEL	CAST_UNIT	31 473	600	18.88
PANEL	CAST_UNIT	13 402	600	8.04
PANEL	CAST_UNIT	11 580	4 676	54.15
PANEL	CAST_UNIT	17 450	200	3.49
PANEL	CAST_UNIT	5 552	2 102	11.67
PANEL	CAST_UNIT	17 450	200	3.49
Category: Area definition > Normal area (3364)		9 446 061	604 770	35 023.39
BASE PLATE	ASSEMBLY	500	480	0.29
BASE PLATE	ASSEMBLY	500	480	0.29
BASE PLATE	ASSEMBLY	500	480	0.29
BASE PLATE	ASSEMBLY	500	480	0.29
Number of objects in the table: 3387		Result of: Total		Of these rows:
		9 721 501	624 894	35 277.41

1.16 Example: Calculate and report areas based on object type and project status in Organizer

In this example, you will create property categories based on the project status. During the project you will move the objects between the categories to reflect the current status of the objects. You will also create property categories to report the area calculations for the selected object groups.

You will combine the properties that the project status and area calculation property categories add to the objects. The report will not show any values for the areas of the objects that are early in the delivery chain, but it shows object type-specific areas for the rest of the objects that are in the later phases in the delivery chain.

To report area values, you will set up two conditions for special area reporting:

- Do not show the area of the objects if the project status is `Approved` for production, but show the area if the project status is something else.
- Calculate the area based on a predefined categorization of the objects.

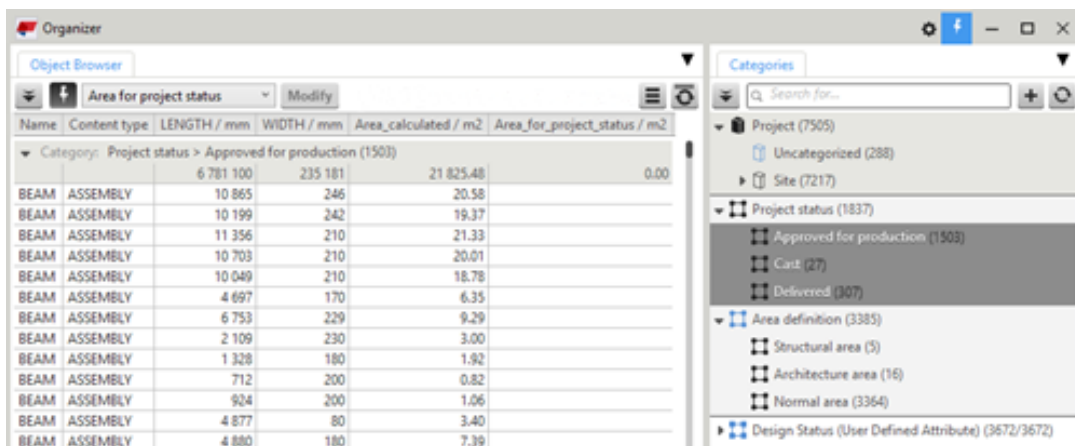
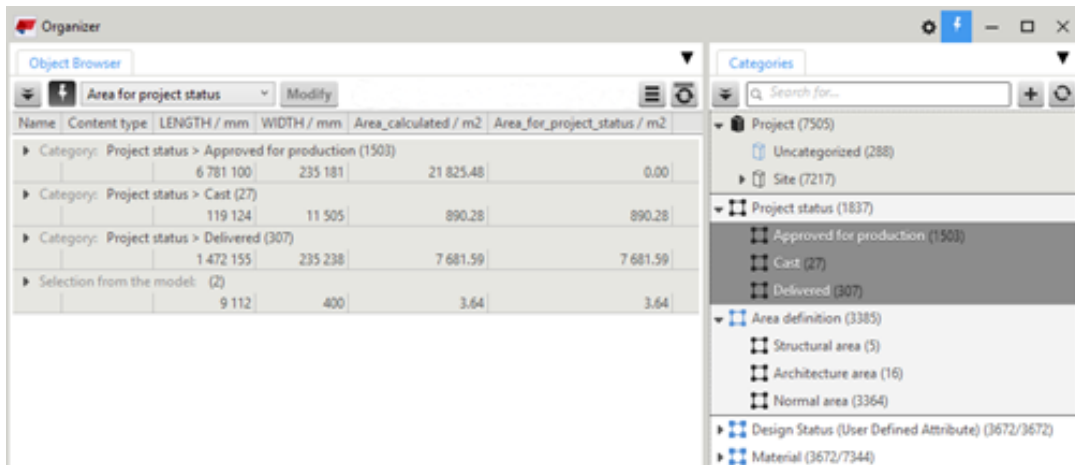



1. To open **Organizer**, click **Manage** on the ribbon and then click **Organizer**.
2. Set up the rules for project status.

First create property categories to define the project statuses of the objects. Then create a property that you will add to these categories to define whether certain report fields get values.

- a. [Create a property category \(page 43\)](#) for the project statuses.

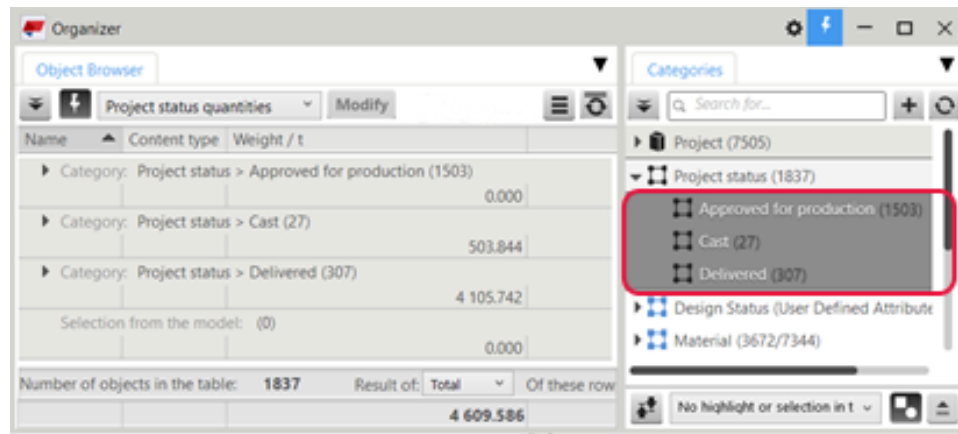
Add all model objects, or a smaller set of objects, to the root-level category, and then create subcategories according to the project statuses.



You can use object  or assembly  type of categories according to your needs. To use assemblies, select the **Include the highest assembly level in the model** option in the category properties.

- b. [Create a property \(page 28\)](#) for the calculations.

Open the **Settings** dialog in **Organizer**,

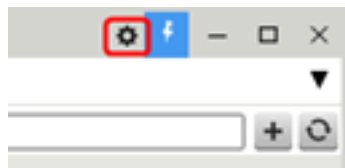

and create the property using the following settings:

- **Name:** Quantity_output
- **Property:** Quantity_output
- **Unit type:** No unit
- **Data type:** Number without decimals
- **Property type:** UDA

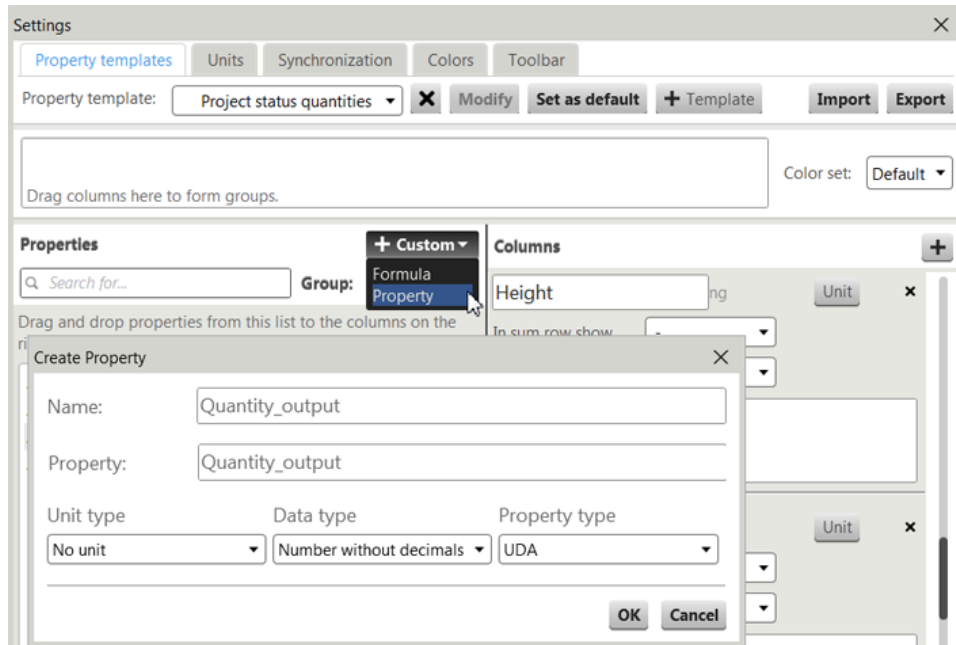

- c. Add the created property to the **Project status** categories to write the values to the model objects. You can then use the values in further calculations.
- Add the `Quantity_output` property in the category properties of the root-level **Project status** category.

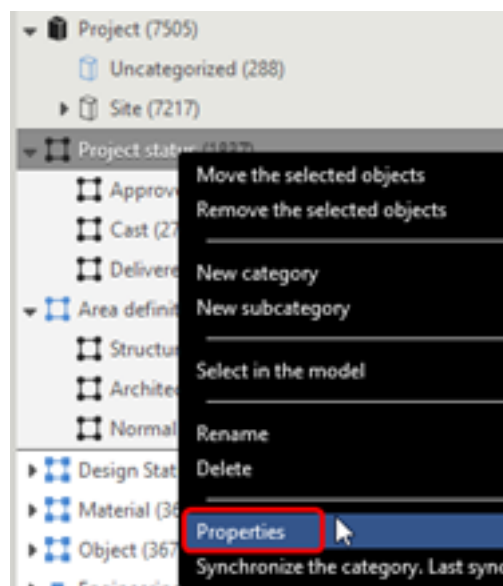

Search for the property in **Object properties**, select it, and click **Modify**.

Category Properties X

Name: (1837)

>> Project status

Rules for setting category content

- Automated object content
- Automated subcategories
- Manually added objects
 - Include the highest assembly level in the model

Object properties

Set the properties and their values to the objects in this category tree to write them to the model

▾

Update category at synchronization

Property template: ▾

Object properties

Set the properties and their values to the objects in this category tree to write them to the model

Property	Type	Value	Unit
Quantity_output	<input type="text" value="Number without deci"/> ▾	<input type="text"/>	<input type="text" value="x"/>
<input type="text" value="Select a property..."/> ▾			

Update category at synchronization

Property template: ▾

- Add a value of the property in the category properties of each lowest-level subcategory.

In the **Value** box, add value 0 where you do not want to have any output, and add 1 where you want to have output. You have to set the value in each lowest-level subcategory.

Category Properties (1503)

Name: Approved for production (1503)

>> Project status > Approved for production

Rules for setting category content

- Automated object content
- Automated subcategories
- Manually added objects
- Include the highest assembly level in the model

Object properties

Set the properties and their values to the objects in this category tree to write them to the model

Property	Inherit value	Type	Value	Unit
Quantity_output	<input type="checkbox"/>	Number without de	0	

Update category at synchronization

Property template: Default

Buttons: Delete Category, Modify, Close

Category Properties (27)

Name: Cast (27)

>> Project status > Cast

Rules for setting category content

- Automated object content
- Automated subcategories
- Manually added objects
- Include the highest assembly level in the model

Object properties

Set the properties and their values to the objects in this category tree to write them to the model

Property	Inherit value	Type	Value	Unit
Quantity_output	<input type="checkbox"/>	Number without de	1	

Update category at synchronization

Property template: Default



Buttons: Delete Category, Modify, Close

3. Set up the rules for area calculation.

First you will create property categories to define the group of objects that need different area calculations. Then you will create formulas for the area calculations, and finally you will add the formulas to the

corresponding categories to write the formula results to the model objects.

a. Create a property category for area calculations.

Add to the category the same model objects that you have added to the **Project status** category. Create subcategories according to the area calculation types. Use the same type of category, object  or assembly , as in the **Project status** category.

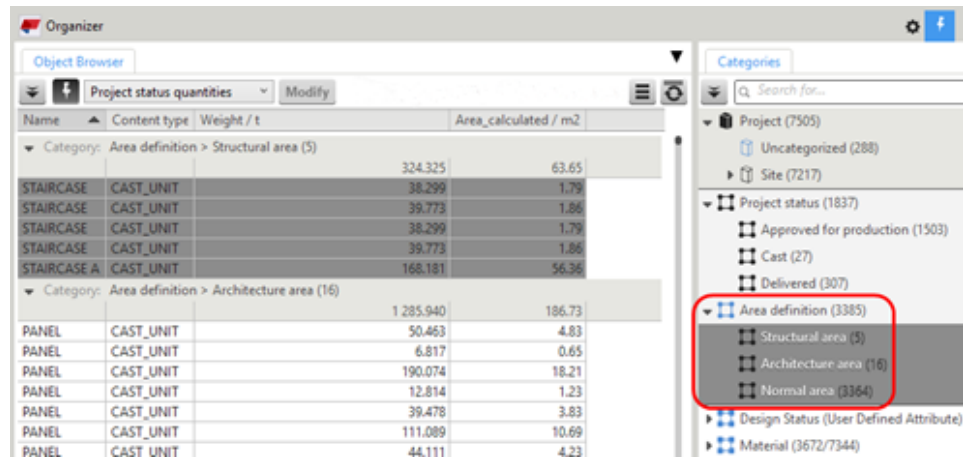

b. Create a property to report the calculated areas.

Open the **Settings** dialog in **Organizer**,

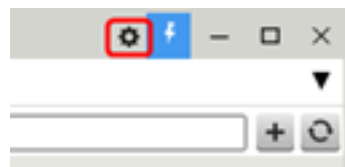

and create the property using the following settings:

- **Name:** Area_calculated
- **Property:** Area_calculated
- **Unit type:** Area
- **Data type:** Number with decimals
- **Property type:** UDA

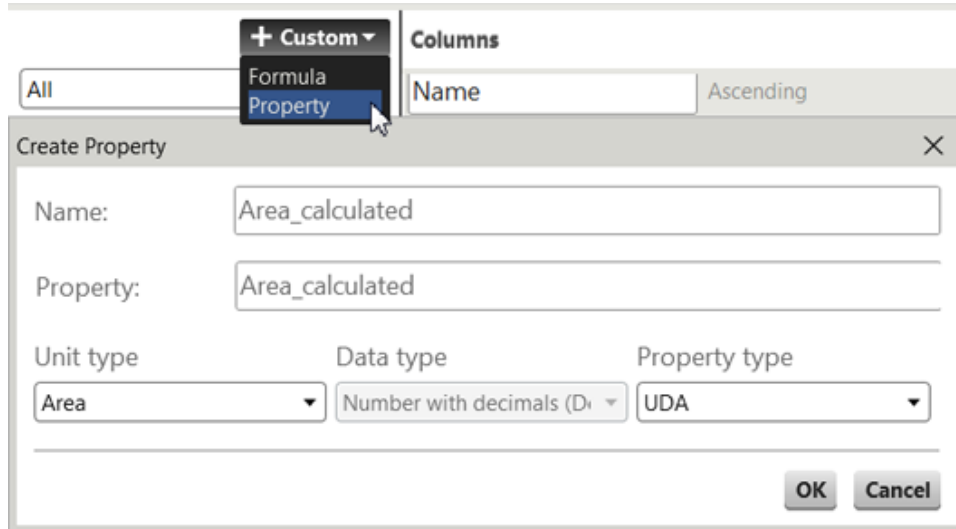

Add the property to the property template you are using to show it as a column in **Object Browser**, and click **Modify**.

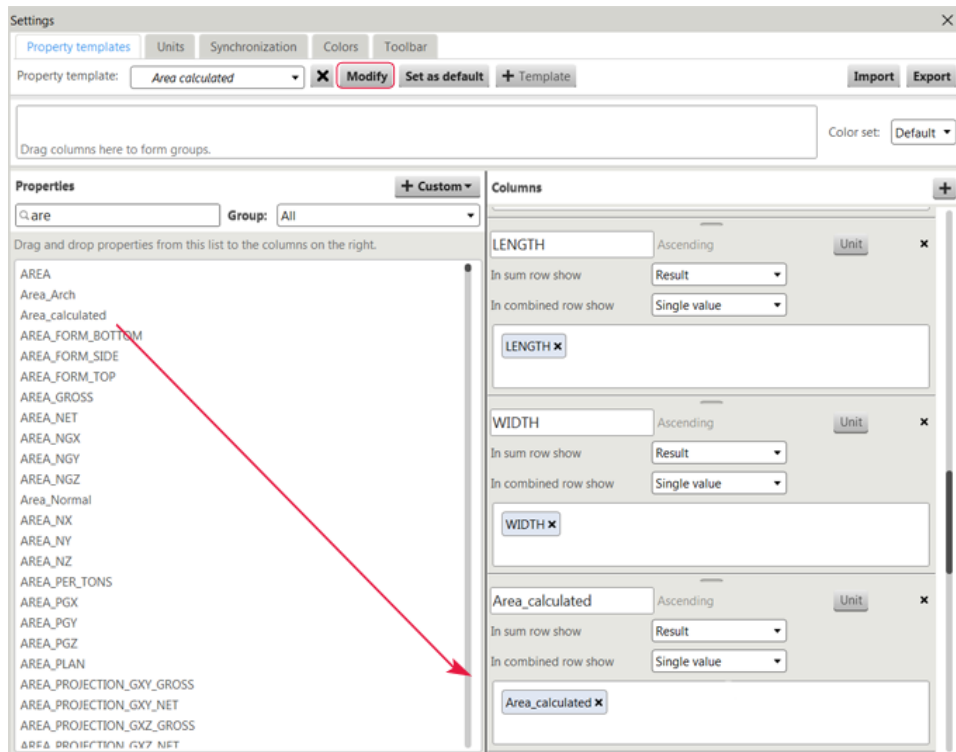

- c. [Create separate formulas \(page 30\)](#) for all the different area calculations.

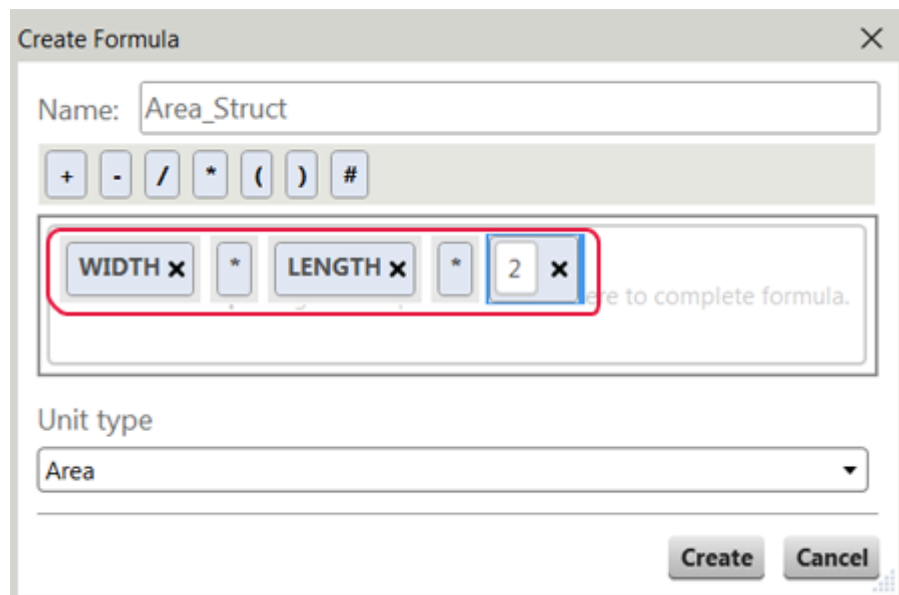
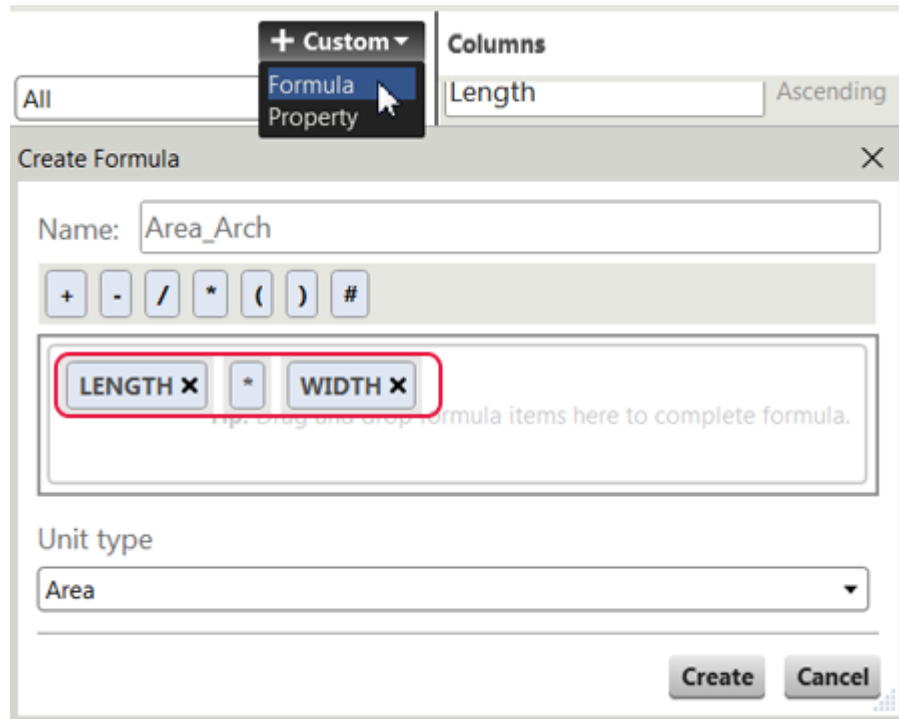

If you do not need special calculations for every object type, you also need to create a simple formula using the default area property of the objects.

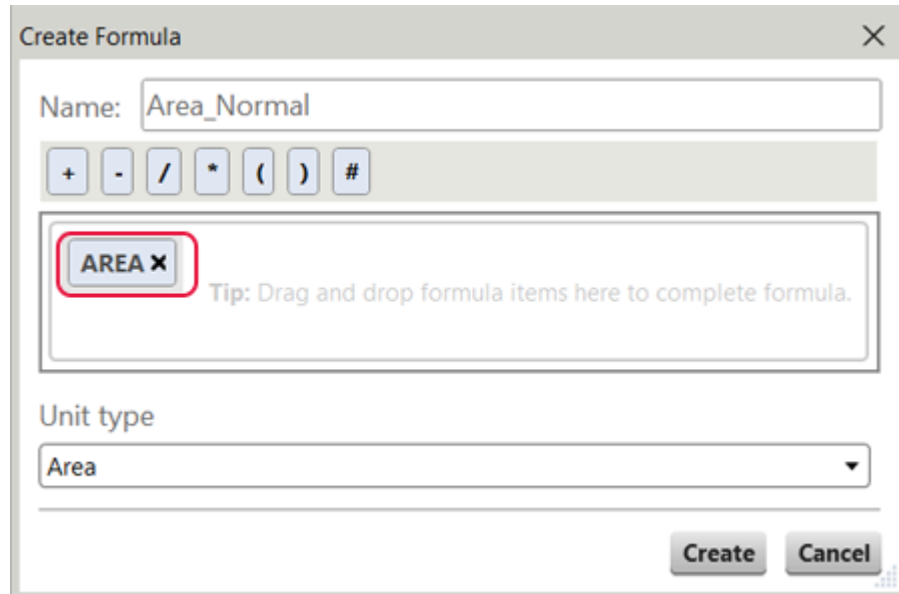

- d. Add the `Area_calculated` property and the formulas to the category properties of the **Area definition** categories to write the values to the model objects.
- Add the property in the category properties of the root-level **Area definition** category.

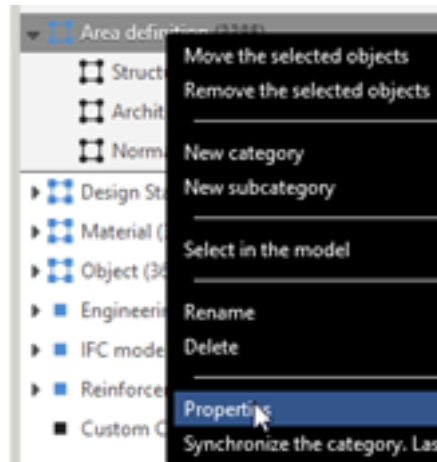

Search for the property in the **Object properties**, select it, and click **Modify**.

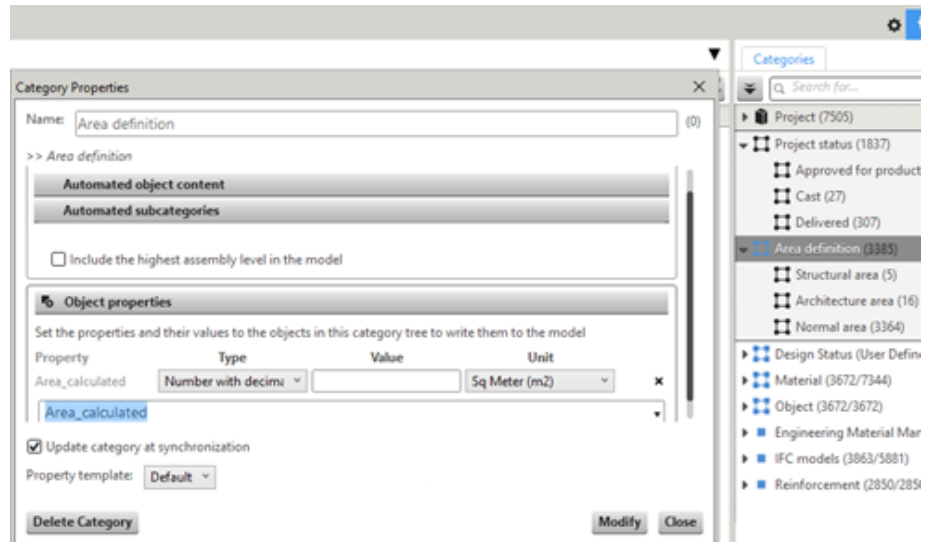

- Add a value to the property in the category properties of each lowest-level subcategory.
 - **Type:** Formula
 - **Value:** Select a formula you previously created.

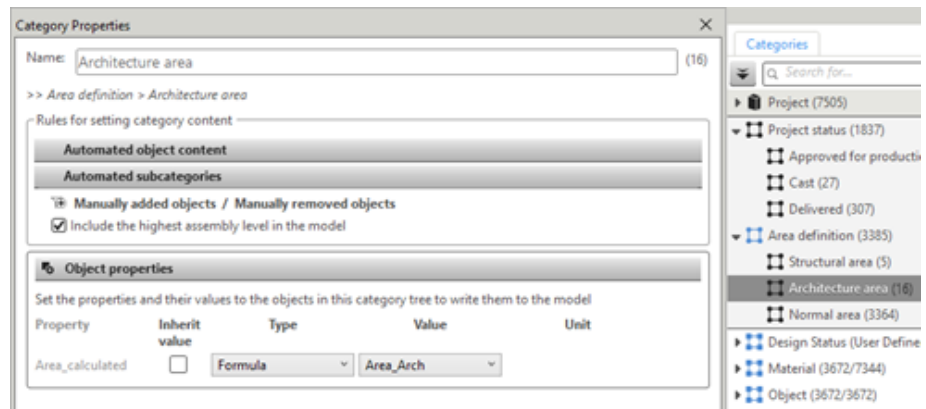
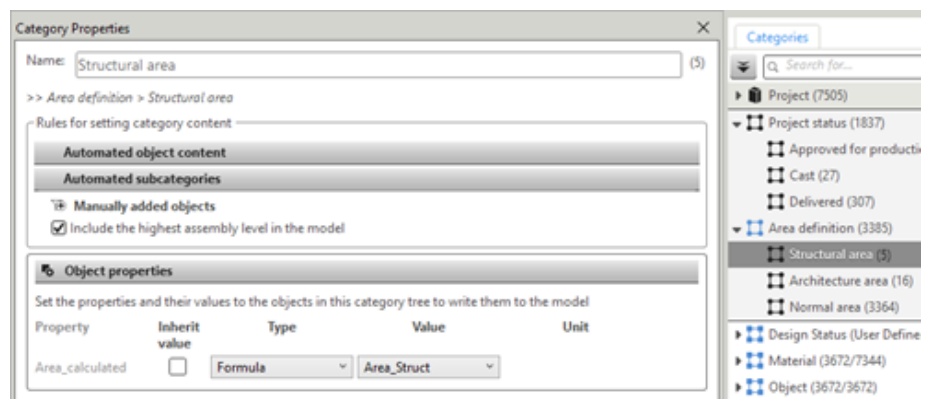

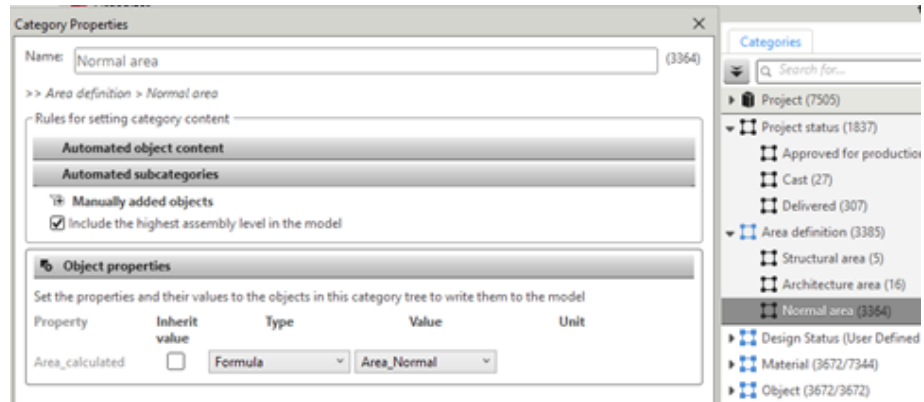

4. Add the area calculations to the **Project status** categories.

Create a formula that uses the `Area_calculated` property written to the objects from the **Area definition** categories, and the `Quantity_output` property written to the objects from the **Project status** categories.

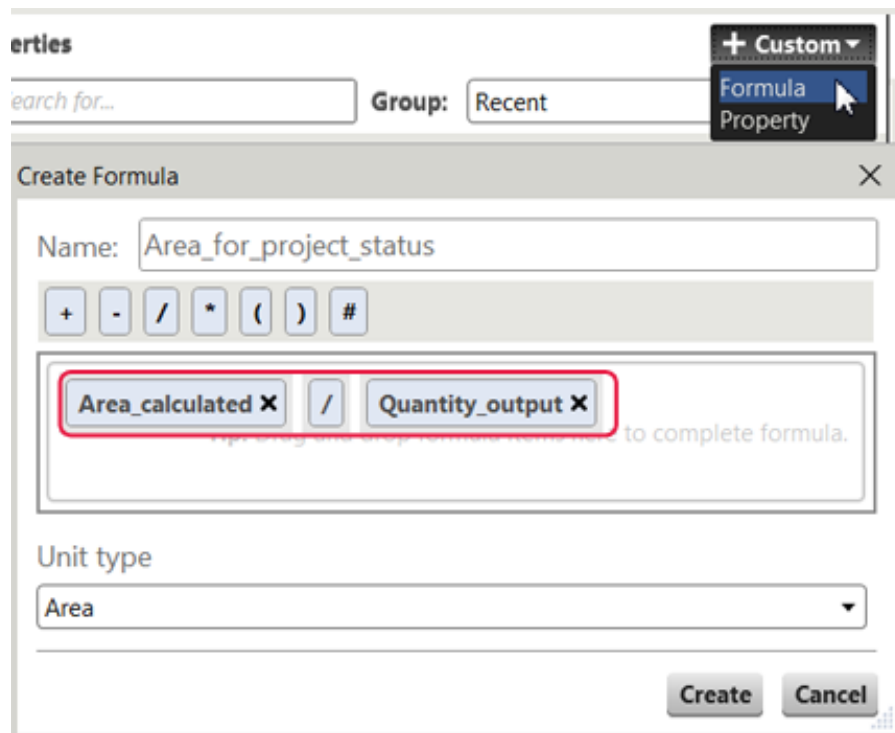

Add the new formula to the property template you are using to show it as a column in **Object Browser**, and click **Modify**.

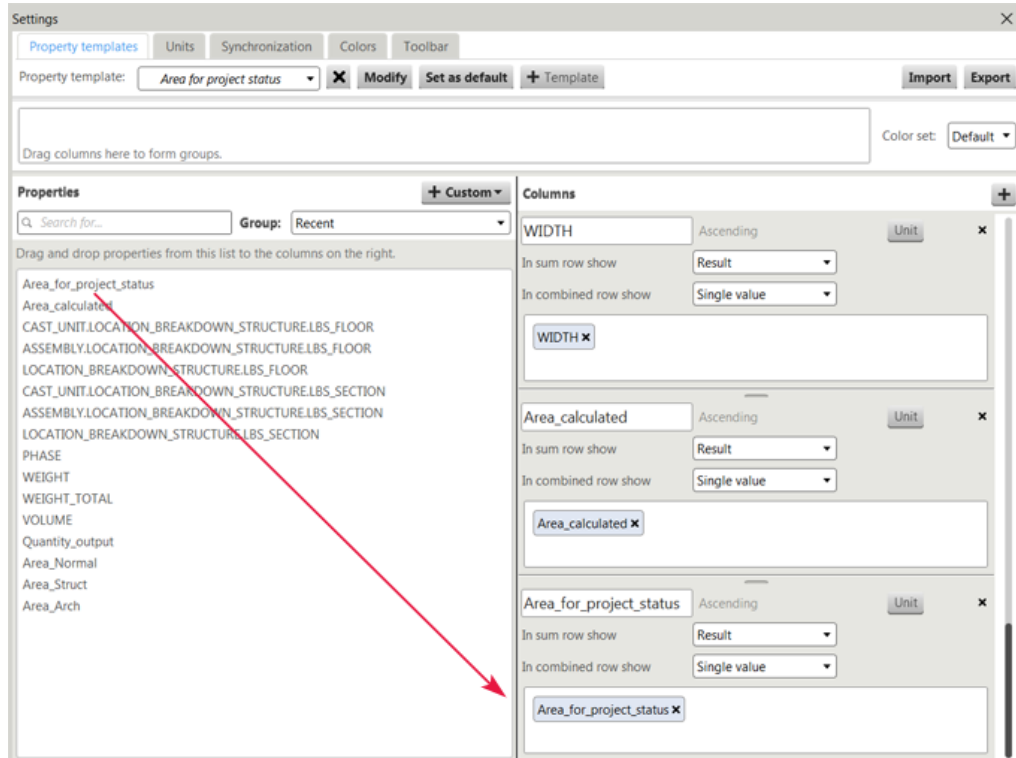

The formula calculates a property value that is shown in the **Area_for_project_status** column in **Object Browser**. If the `Quantity_output` in the formula is 1, a property value is shown in **Object Browser**. If `Quantity_output` is 0, **Organizer** does not add a value to the object property. When the `Quantity_output` value is 0, the `Area_for_project_status` formula equals `Area_calculated/0`.

5. Synchronize **Organizer** to calculate the new UDA values and write them to the model objects.

You can either synchronize **Organizer**, or only the property category tree.

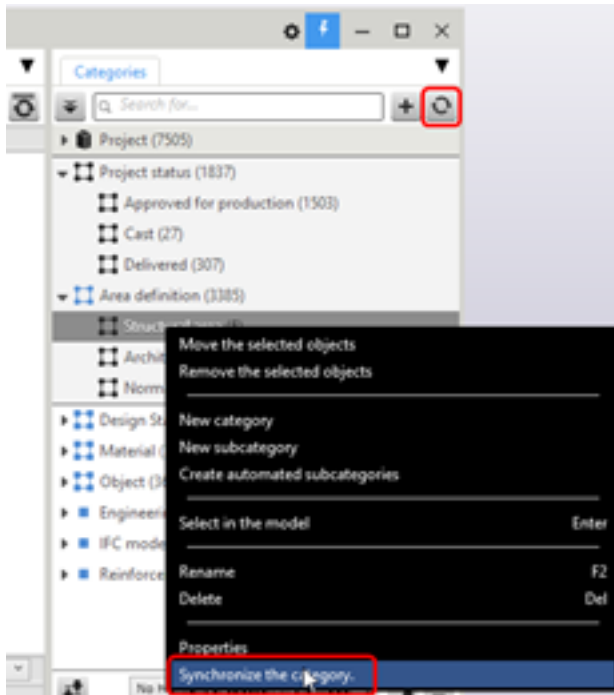

6. View the report in **Object Browser**.

In the image below, the five objects selected in **Object Browser** have the area values calculated based on the definition in the **Structural area** category.

Name	Content type	LENGTH / mm	WIDTH / mm	Area_calculated / m2	Area_for_project_status / m2
Category: Project status > Approved for production (1503)					
		6 781 100	235 181	21 825.48	0.00
Category: Project status > Cast (27)					
		119 124	11 505	890.28	890.28
STAIR	CAST_UNIT	3 590	200	31.23	31.23
STAIR	CAST_UNIT	4 085	200	35.31	35.31
STAIR	CAST_UNIT	7 200	200	61.04	61.04
SLAB	CAST_UNIT	1 500	160	14.24	14.24
STAIR	CAST_UNIT	4 085	200	35.31	35.31
STAIR	CAST_UNIT	3 590	200	31.23	31.23
STAIR	CAST_UNIT	3 000	2 000	19.42	19.42
STAIR	CAST_UNIT	3 590	200	31.79	31.79
STAIR	CAST_UNIT	3 590	200	31.79	31.79
STAIR	CAST_UNIT	4 085	200	35.96	35.96
STAIR	CAST_UNIT	7 200	200	62.15	62.15
STAIR	CAST_UNIT	4 085	200	35.96	35.96
STAIR	CAST_UNIT	3 590	200	31.79	31.79
STAIR	CAST_UNIT	3 590	200	31.79	31.79
STAIR	CAST_UNIT	4 085	200	35.96	35.96
STAIR	CAST_UNIT	7 200	200	62.15	62.15
STAIR	CAST_UNIT	4 085	200	35.96	35.96
STAIR	CAST_UNIT	3 590	200	32.74	32.74
STAIR	CAST_UNIT	3 590	200	32.74	32.74
STAIR	CAST_UNIT	4 085	200	37.03	37.03
STAIR	CAST_UNIT	7 200	200	64.00	64.00
STAIR	CAST_UNIT	4 085	200	37.03	37.03
STAIR	CAST_UNIT	4 642	200	1.86	1.86
STAIR	CAST_UNIT	4 470	200	1.79	1.79
STAIR	CAST_UNIT	4 642	200	1.86	1.86
STAIR	CAST_UNIT	4 470	200	1.79	1.79
STAIR	CAST_UNIT	6 200	4 545	56.36	56.36
Category: Project status > Delivered (307)					
		1 472 155	235 238	7 681.59	7 681.59
Selection from the model: (2)					
		9 112	400	3.64	3.64
Number of objects in the table: 1839					
		8 381 491	482 324	30 401.00	8 575.52

In the **Approved for production** category, the objects have no area values in the **Area_for_project_status** column, so the total sum is 0.

Name	Content type	LENGTH / mm	WIDTH / mm	Area_calculated / m2	Area_for_project_status / m2
Category: Project status > Approved for production (1503)					
		6 781 100	235 181	21 825.48	0.00
BEAM	ASSEMBLY	10 865	246	20.58	
BEAM	ASSEMBLY	10 199	242	19.37	
BEAM	ASSEMBLY	11 356	210	21.33	
BEAM	ASSEMBLY	10 703	210	20.01	
BEAM	ASSEMBLY	10 049	210	18.78	
BEAM	ASSEMBLY	4 697	170	6.35	
BEAM	ASSEMBLY	6 753	229	9.29	
BEAM	ASSEMBLY	2 109	230	3.00	
BEAM	ASSEMBLY	1 328	180	1.92	
BEAM	ASSEMBLY	712	200	0.82	
BEAM	ASSEMBLY	924	200	1.06	
BEAM	ASSEMBLY	4 877	80	3.40	
BEAM	ASSEMBLY	4 880	180	7.39	

NOTE To show the categories as groups, select the **Separate categories** option on the **Object Browser** menu.

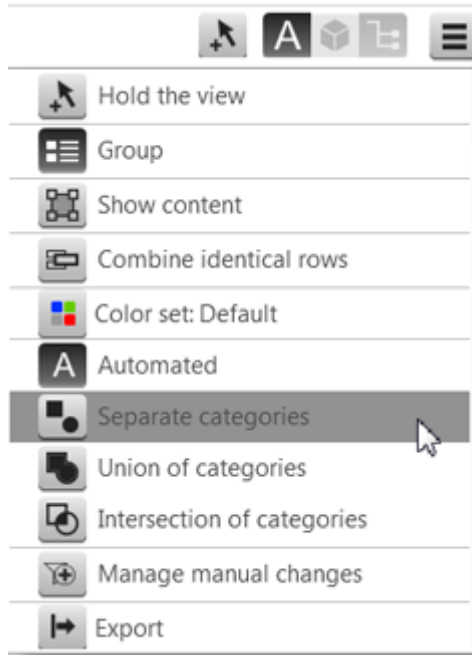

The UDAs added by **Organizer** are also shown in the **Inquire object** dialog.

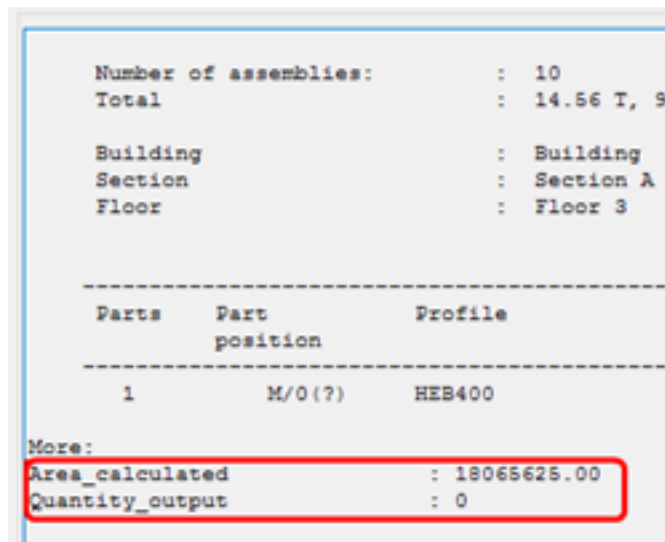



1.17 Example: Add a classification code to objects in Organizer and export the code to IFC

You can add a classification code to the user-defined attributes of objects through a property category in **Organizer** and export the code with the objects to an IFC file.

1. To open **Organizer**, click **Manage** on the ribbon and then click **Organizer**.
2. Create the classification categories that you need as [property categories](#) (page 43).

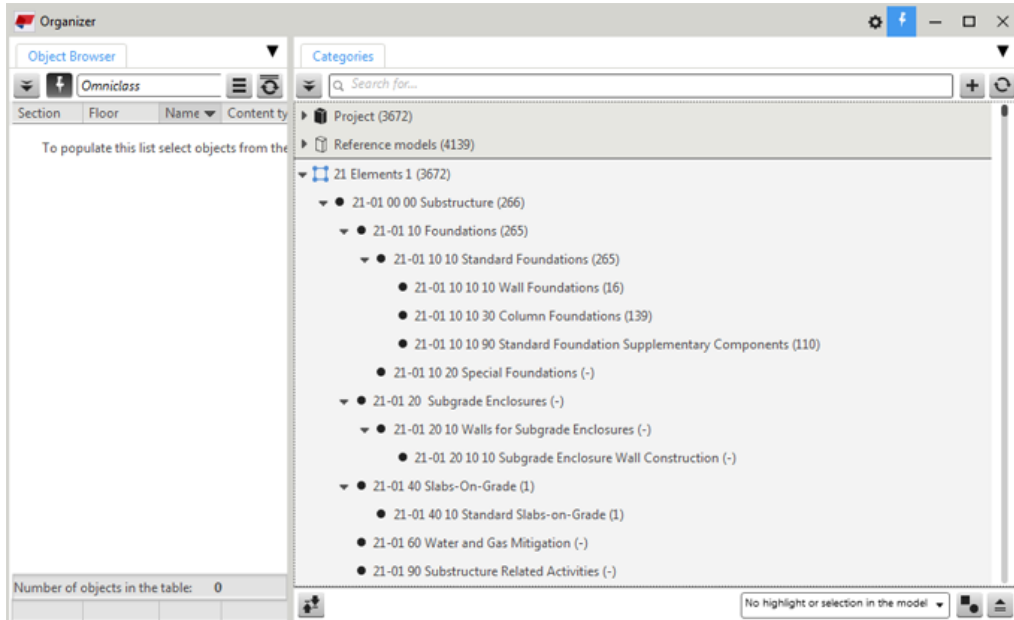
Property categories have round icons in the category tree.



3. Create a custom property that you will use in the classification.
 - a. Click  in the upper-right corner of **Organizer** to open the **Settings** and click **Custom** --> **Property**.

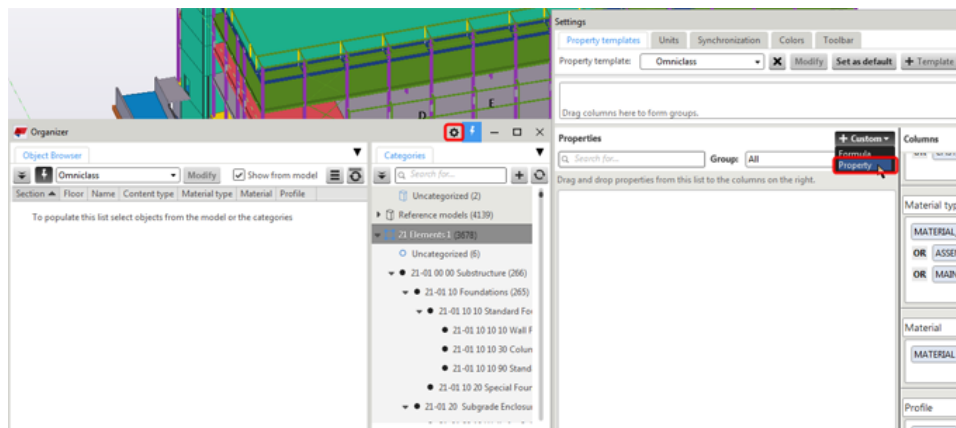

- b. Define the custom property as shown in the image below. Set the property type to **UDA**.

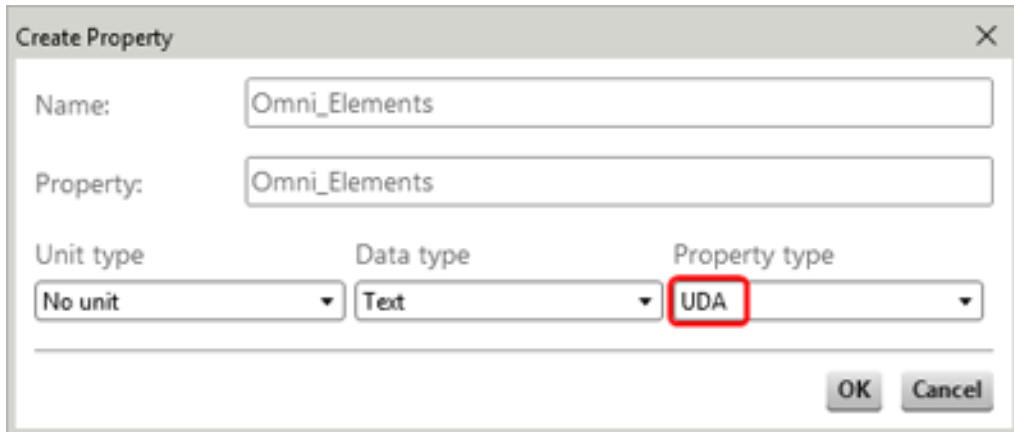

If you want, you can add the property to the `objects.inp` file to see the property in the user-defined attributes dialog.

4. Add the custom property to a property template.

If you do not have a suitable property template, [create a new template](#) (page 24).

- a. Search for the custom property you created and drag it to the selected template.

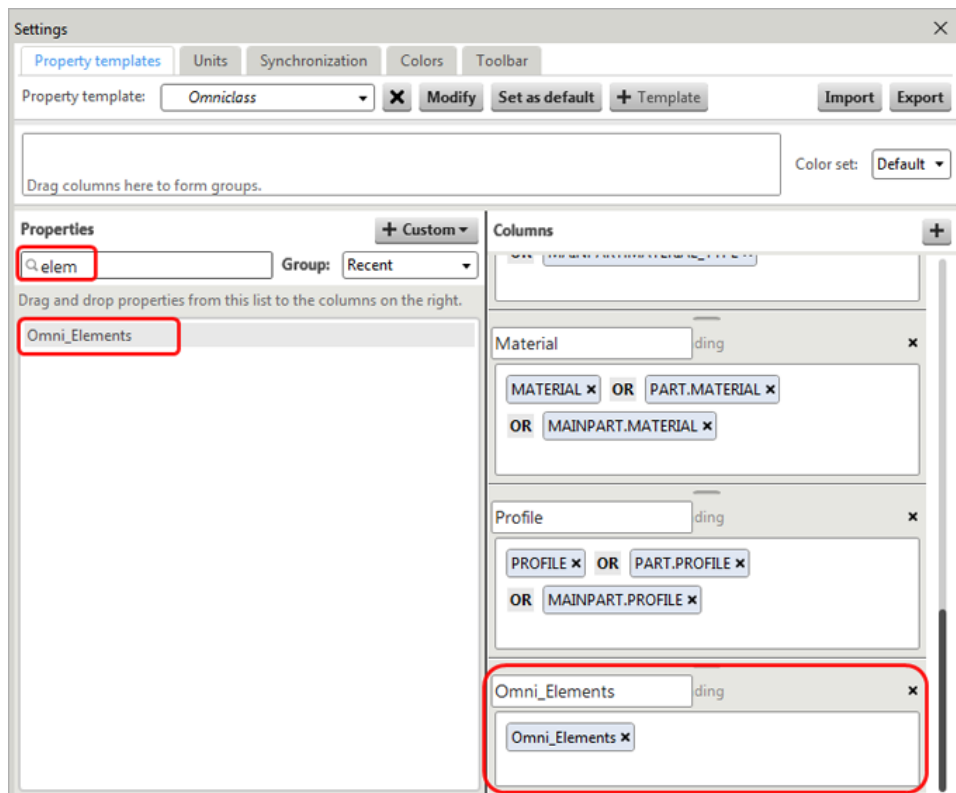

- b. Click **Modify** to save the template and close the settings.

5. Add the custom property to the property category you created earlier.

- a. Double-click the root property category to open the category properties.
- b. Under **Object properties**, select the custom property you created.

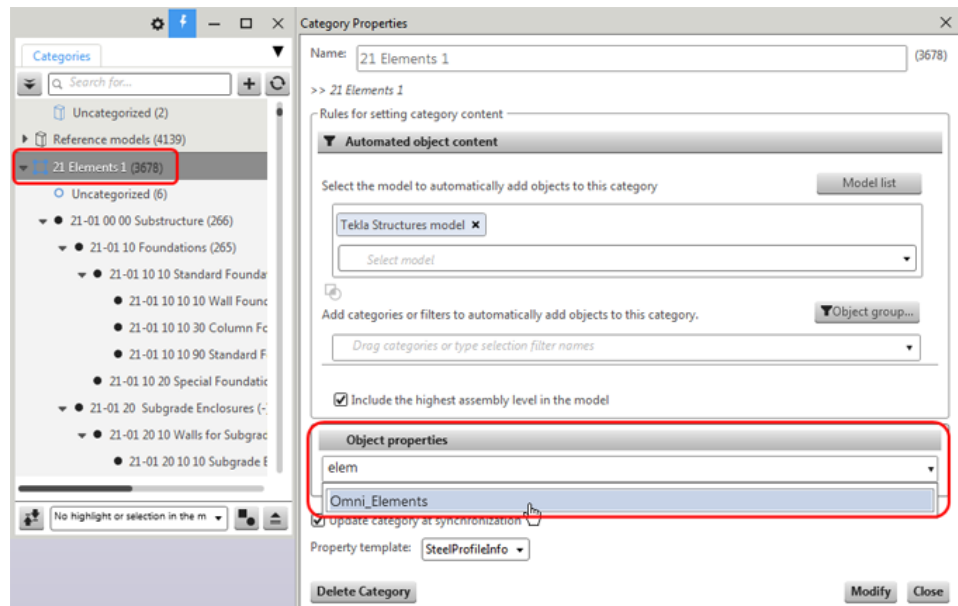

- c. Click **Modify** to save the changes.

Now all the subcategories under the property category have the same custom property. The lowest subcategories will add the custom property to the objects with the values you will define next.

6. Set the custom property value in the subcategories to add the value to the objects.

You can add different property values in all subcategories.

- a. Double-click a lowest level subcategory to open category properties.
- b. Add the custom property value that you want to write to the objects in the selected subcategory.

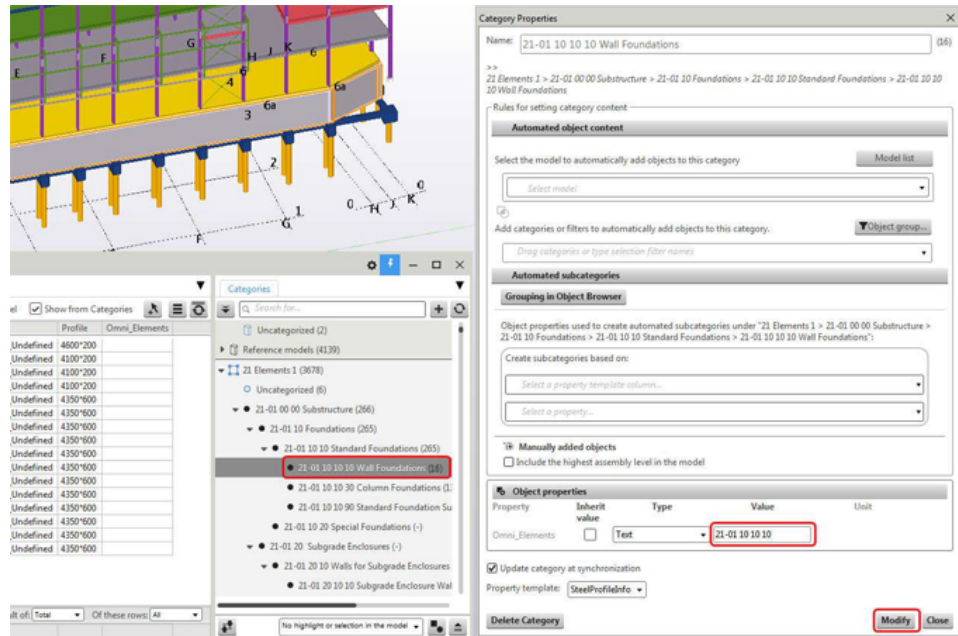

c. Click **Modify** to save the changes.

7. Synchronize the property category to write the property values to the model objects.

Select any subcategory in the property category, right-click and select **Synchronize category**.

The whole category tree is synchronized.

You can check the result in **Object Browser**, or by inquiring an object.

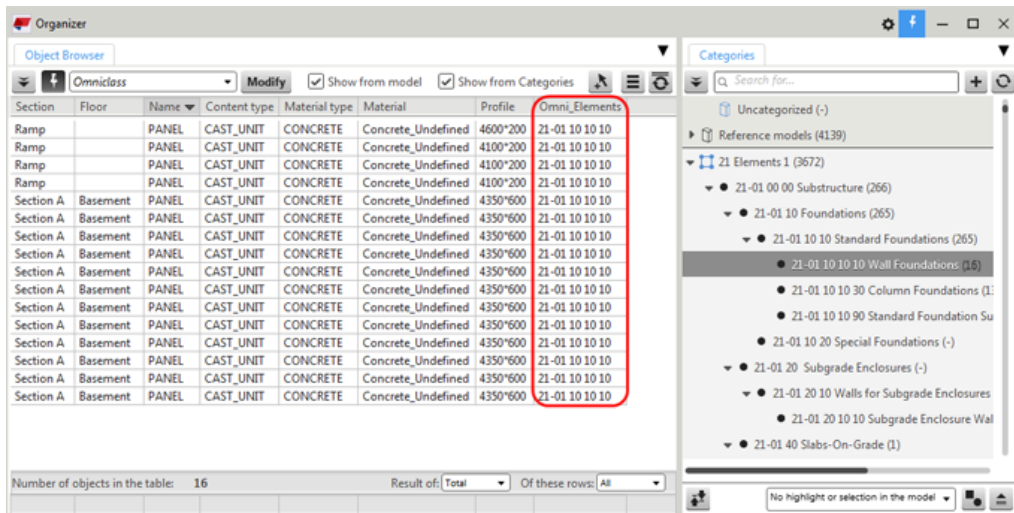

8. Add the classification code to the project properties.

- a. On the **File** menu, click **Project properties --> User-defined attributes**.

- b. Add the classification code to the **Classification system** box.

Use the name that you added to the **Property** option when creating the custom property.

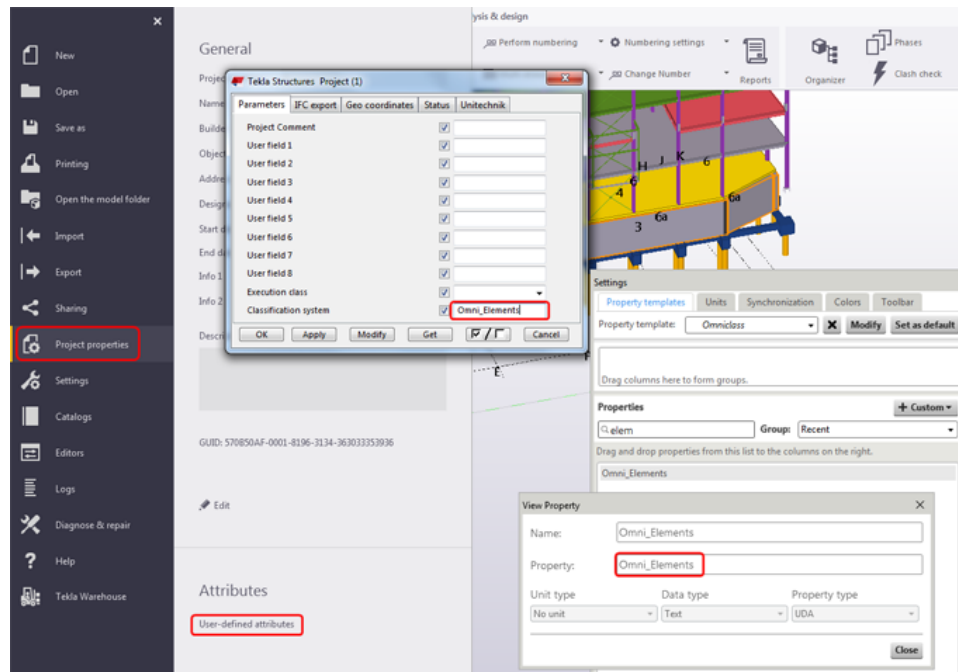

You can add one classification code at a time this way.

9. Export the classification code to an IFC file.
 - a. On the **File** menu, click **Export --> IFC** .
The classification code is exported with assemblies even if you have added it to parts.
 - b. Check the result in the exported model.

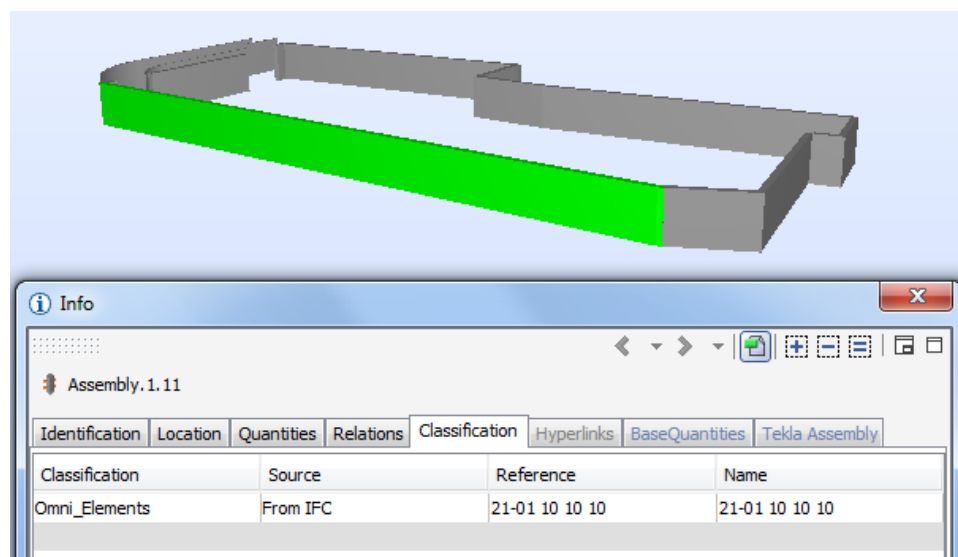

1.18 Example: Create a custom category for structural design status in Organizer

1. To open **Organizer**, click **Manage** on the ribbon and then click **Organizer**.
2. Create a new category, right-click the category and select **Properties**. Enter **Design Status (User Defined Attribute)** as the name of the category.
3. Set the category rules to create automated subcategories using **Grouping in Object Browser** based on the design status that has been assigned for each model part under the UDA.

Category Properties

Name: Design Status (User Defined Attribute) (657)

>> Design Status (User Defined Attribute)

Rules for setting category content

Automated object content

Select the model to automatically add objects to this category Model list

Select model

Add categories or filters to automatically add objects to this category. Object group...

standard x

Drag categories or type selection filter names

Drag categories or type selection filter names

Automated subcategories

Grouping in Object Browser

Object properties used to create automated subcategories under "Design Status (User Defined Attribute)":

Create subcategories based on:

MAINPART.PLANS_STATUS x OR UDA - PLANS_STATUS x

OR ASSEMBLY.MAINPART.PLANS_STATUS x

OR CAST_UNIT.MAINPART.PLANS_STATUS x OR PLANS_STATUS x

Update category at synchronization

Property template: Default

Delete Category Modify Close

You can now use the categories in managing the structural design status of your project.

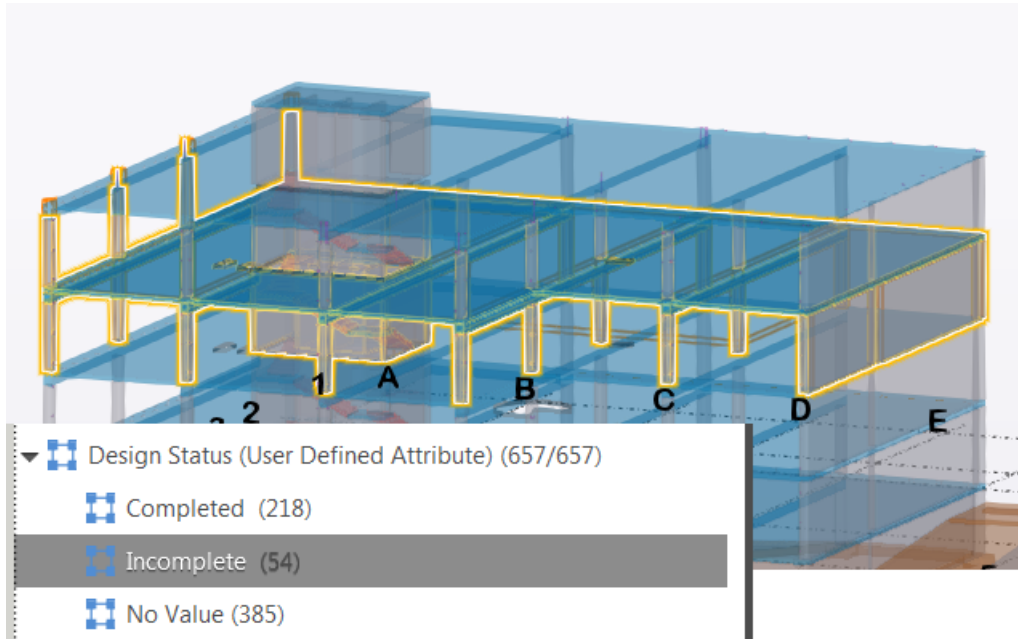

See also

[Example: Create a custom category for architectural design status in Organizer \(page 118\)](#)

[Organizer \(page 7\)](#)

1.19 Example: Create a custom category for architectural design status in Organizer

Your design team may want to communicate the design status of the parts in their model to ensure that other project members only focus on areas where the design has reached maturity.

1. Ensure that the architectural team places an IFC attribute to each object, such as `Architectural_Status`, which can be included in the IFC file that they share. In ArchiCAD, this can be done by simply adding an IFC property to the objects called, for example, `Status`. In Revit, this can be done by using the Revit comment attribute found on each Revit Family Instance.
2. In Tekla Structures, use the **Add model** command to place the architectural IFC model in the correct location and ensure that the model is subdivided.
3. To open **Organizer**, click **Manage** on the ribbon and then click **Organizer**.

4. Create a new category, right-click the category and select **Properties**. Enter **Architectural_Status** as the category name.
5. Add the **Object type - Reference Object** filter to the rule box for categories and filters, or a locally set filter that will find all reference objects in the model.



6. Create a new property to allow Tekla Structures to read comments from the ArchiCAD / Revit IFC file. To find the name used by the IFC file, select an IFC object, right-click and select the **Inquire** command. Find the property name in the **Inquire object** dialog and copy it.
7. Create a new property template. Click  in the upper-right corner of **Organizer** to open the **Settings** and click **Template**. Select to create a blank template and enter **Arch_Comments_attribute** as the name of the new template. Save the template.
8. In **Settings**, create a new property:
 - a. Select **Custom** from the **Group** list.
 - b. Then click the **Custom** button and select **Property**.
In this example, you will add a `Revit_Comments` property.
 - c. Enter the word `EXTERNAL.` in capital letters to the beginning of the property name in the **Property** box, then paste or write the property you copied in the **Inquire object** dialog.

For example, the correct notation could be `EXTERNAL.Identity
Data.Comments`.

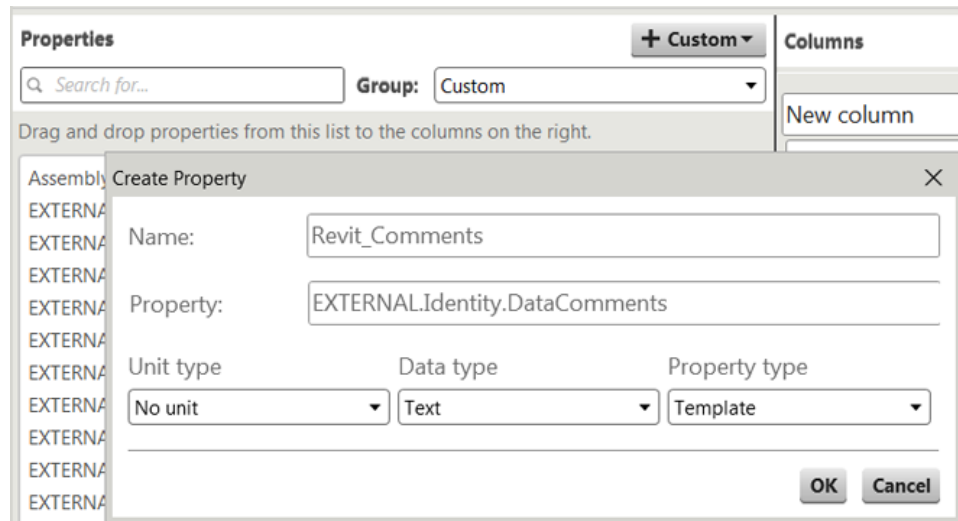

- d. Click **OK**, add the new property to the new template, click **Modify**, and close **Settings**.
9. Select the **Architectural_Status** category. Ensure that **Object Browser** is showing the **Arch_Comments_attribute** grouping information. Right-click the **Architectural_Status** category and select **Create automated subcategories** to create subcategories using the property values. Create the subcategories using **Grouping in Object Browser** and click **Modify**.

The categories are now as follows:

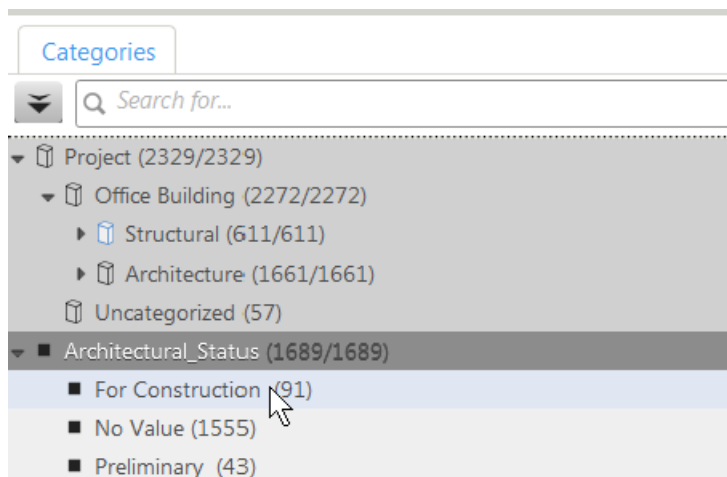

You can now automatically track the status of architectural IFC objects in the Tekla Structures model.

See also

[Organizer \(page 7\)](#)

[Example: Create a custom category for structural design status in Organizer \(page 117\)](#)

1.20 Example: Organizer for steel - manage bolts

You can use **Organizer** to quickly get the quantities of the bolts required for a project. In addition to the raw quantities, **Object Browser** lets you group and sub-total by bolt standard, diameter, and length as well as by where the bolt will be used (shop or site).

1. To open **Organizer**, click **Manage** on the ribbon and then click **Organizer**.
2. Click  in the upper-right corner of **Organizer** to open the **Settings**.
3. Click **Template** to create a new template. Enter **Bolt summary** as the template name, select the **Blank template** option, and click **Create** to create the new template.
4. Next, select **BOLT** from the **Group** list, and from the available properties in the list drag the following properties to the **Columns**:
 - `TYPE` - The bolt standard (for example, 7990, A325, F10T).
 - `DIAMETER` - The nominal diameter of the bolt.
 - `LENGTH` - The nominal length of the bolt.
 - `SITE_WORKSHOP` - Where the bolt is to be used.
 - `NUMBER` - The number of bolts in the bolt group.

Set the **In sum row show** option to - for `DIAMETER` and `LENGTH` so that the result is not shown in the sum row.

You can also add `CONTENTTYPE`, which shows the type of the object that is being reported in a row. This is useful for checking the results and identifying when something other than a bolt is being reported.

5. Click **Modify** to save your changes and close the **Settings** dialog.
6. Select some bolts (and optionally other objects as well) in the model.
7. Click  to reload the view in **Object Browser** to ensure that the latest information is shown and verify that the bolt information is correctly reported. At this point, you could edit your **Bolt summary** template further to add additional information, such as the main part phase, or create a custom property to calculate and report the weight of the bolts, nuts, and washers in the bolt group.

Next, you can use **Object Browser** to summarize the bolt quantities in your selection.

8. Click  in **Object Browser** and select **Group**.

- a. Drag the **Type** column to the grouping row.
You now have a summary of the different types of bolts used in your selection.
- b. Drag the **Diameter** column and then the **Length** column to the right side of **Type** in the grouping row.

Object Browser now gives you a breakdown of the number of bolts first by type, then by diameter, and then by length.

You could now also drag the **SITE_WORKSHOP** column at the end of the grouping row to further break down the bolts by location, or drag the column to the beginning of the grouping row to first break down the bolts by location, then by type, diameter, and length. Other properties could also be used to group and summarize the bolts.

9. Customize the template and grouping to suit your needs and click **Modify** to save the template. Now you can use the grouping of your template to categorize all the bolts in the model.
10. Next, create a new custom category, right-click the category and select **Properties**. Enter **Bolts** as the name of the category.
11. Define the properties of the category as follows:
 - a. Ensure that the **Include the highest assembly level in the model** checkbox is not selected.
 - b. Under **Automated object content**, click in the rule box for categories and filters, and select the `Object type - Bolt` filter from the list of filters.

Note that the `Object type - Bolt` filter selects all bolt group objects including the ones that create only bolt holes as well as studs.
 - c. Ensure that the **Update category at synchronization** checkbox is selected.
 - d. Select the **Bolt summary** property template from the **Property template** list.
 - e. Click **Modify**.

All bolt objects in the model are now added to the category. In **Object Browser**, the properties of the bolts are shown using the **Bolt summary** template.

You can now automatically categorize all the bolts in the model using the same breakdown as in the bolt summary.

12. Right-click the **Bolts** category and select **Create automated subcategories**.
13. Click **Grouping in Object Browser**.
14. Click **Modify**.

You now have a **Bolts** category which is broken down into a tree based on the grouping in your **Bolt summary** template. If any changes are made to the model, you can simply synchronize this category to automatically update the breakdown. New bolts will be found and added to the correct subcategories, or a new subcategory will be created if necessary. For example, if a new bolt standard or diameter is added to the model, a new subcategory for that bolt standard or diameter will automatically be created in the tree when you synchronize the **Bolt** category with the model.

You could now export the **Bolt summary** property template, as well as the **Bolts** category for use in other projects.

See also

[Example: Organizer for steel - manage assemblies \(page 123\)](#)
[Organizer \(page 7\)](#)

1.21 Example: Organizer for steel - manage assemblies

The categories in **Organizer** can help manage the amount of work for a project by breaking down the assemblies by phase and assembly type. This can help in estimating the amount of work required to detail and/or fabricate the project even before the model has been detailed.

This example assumes that the model has been divided into two or more phases using **Phase Manager**. The model could be a design model with no detailing, or it could be a fully detailed model.

1. To open **Organizer**, click **Manage** on the ribbon and then click **Organizer**.
2. Create a new custom category, right-click the category and select **Properties**. Enter **Assemblies by phase** as the name of the category.
3. Define the properties of the category as follows:
 - a. Ensure that the **Include the highest assembly level in the model** checkbox is selected.
 - b. Under **Automated object content**, click the **Select model** list and select the Tekla Structures model to avoid getting any reference model assemblies to the category.
 - c. Ensure that the **Update category at synchronization** checkbox is selected.
 - d. Select the **Erection** property template from the **Property template** list.
 - e. Click **Modify**.

The steel assemblies in the model are now added to the category and their erection information is shown in **Object Browser**.

4. Next, click  in **Object Browser** and select **Group**:
 - a. Drag the **Phase** (or **Phase Name**) column to the grouping row.
 - b. Drag the **Name** column to the grouping row.

You can further group by any additional properties you would like to use to break down the work of each phase.

5. Right-click the **Assemblies by phase** category and select **Create automated subcategories**.
6. Click **Grouping in Object Browser**.
7. Click **Modify**.

You now have the **Assemblies by phase** category broken down into subcategories by phase, then by name.

This now gives you a breakdown of the number and kinds of assemblies in each phase, which can be used to quickly estimate the amount of work in each phase. As the model is detailed or changes are made to the project, you can simply synchronize this category to automatically update the breakdown. This could be used to track and check the workload of each phase against production capacity or available resources as the project progresses.

Once detailing has started, the **DrawingsFromModel Object Browser** property template could be used to check the availability and status of drawings for assemblies in each phase.

See also

[Example: Organizer for steel - manage bolts \(page 121\)](#)

[Organizer \(page 7\)](#)

1.22 Example: Organizer for precast

You can use **Organizer** to view the properties of model objects, for example, based on custom and standard property types.

1. To open **Organizer**, click **Manage** on the ribbon and then click **Organizer**.
2. Create delivery lot categories `DeliveryLot_1...n`.
3. Add sequences to the objects in cast units using **Task manager** or the **Sequencer** tool.

For example, if you use the **Sequencer** tool, enter a `sequence name` as the sequence property. The sequence could be the installation sequence. You can check that the property exists by using the **Inquire object** command.

4. Click  in the upper-right corner of **Organizer** to open the **Settings**.

5. Create a new property template for cast units.
6. Create a custom property for the sequence property:
 - a. Set the **Data type** to **Number without decimals**.
 - b. Set the **Property type** to **UDA**.

You can use the **Inquire object** command to find the sequence property. Copy the property to the **Create Property** dialog in **Organizer**.
7. Add the custom property as a new property column to the new property template.
8. Set the sorting of the custom property column.
9. Save the template.
10. Close the **Settings**.
11. Sort the cast units based on the sequence property in **Object Browser**.
12. Select the cast units that have the same sequence property.
13. Select **Selected** from the **Of these rows** list at the bottom in **Object Browser**.
14. Select an option from the **Result of** list, for example, to show the total or average weight of the selected cast units.
15. Select a delivery lot category in **Categories** and add the selected cast units to the category.
16. Select the **Select objects in the model** option from the list at the bottom in **Categories**.
17. Export the selected cast units from **Settings** to an Excel file.
18. You can also create property categories to quickly manage object property data. Create a new property category and open the category properties.
19. Define the category properties:
 - a. Enter **Fabrication Status** as the category name.
 - b. Select the Tekla Structures model from the list of models.
 - c. Set the automatic object content with **Organizer** filters to select all precast concrete assemblies in the delivery lot categories.
 - d. Select the previously created property template.
 - e. Under **Object properties**, select the UDA - FABRICATION_STATUS property.

Category Properties

Name: (0)

>> Property Category

Rules for setting category content

Automated object content

Select the model to automatically add objects to this category

Automated subcategories

Include the highest assembly level in the model

Object properties

Property	Type	Value	Unit
UDA - FABRICATIO	<input type="text" value="Text"/>	<input type="text"/>	<input type="text"/>

Update category at synchronization

Property template:

20. Create automated subcategories based on UDA – FABRICATION_STATUS. **Organizer** automatically creates categories based on the properties that are now already in the user-defined attributes of objects.

You can also create the subcategories manually: **Scheduled for fabrication, In storage, Delivered, and On hold.**

21. Now open the subcategory properties and set the type of the property to **Category name** for UDA – FABRICATION_STATUS.

Object properties				
Property	Inherit value	Type	Value	Unit
UDA - FABRICATIOI	<input type="checkbox"/>	Category name	Delivered	

22. Now move the uncategorized delivery lot objects between the new subcategories to easily assign statuses to the objects. Synchronize the category with the model.

You can also use **Object Browser** to conveniently overview the statuses assigned both in the categories and in the object property dialogs.

See also

[Organizer \(page 7\)](#)

[Sequencer \(page 170\)](#)

2 Building hierarchy

You can use **Building hierarchy** to define a location breakdown structure in your model. **Building hierarchy** can have the following hierarchy structure in Tekla Structures: project > site > building > building section > building storey > space.

You can add multiple buildings, building sections, building storeys and spaces to the model by creating them directly in your model. You can import building storeys and spaces from a reference model when both the reference model and the Tekla Structures model contain one building each.

You can use the model-specific `XS_USE_INTEGRATED_BUILDING_HIERARCHIES` advanced option to control whether the **Building hierarchy** functionality is in use. By default, the advanced option is set to `TRUE` and **Building hierarchy** is in use in new models. The hierarchy structure you define is shown in the **Building hierarchy** side pane and in **Organizer**, and it is used in IFC export.

To open the **Building hierarchy** side pane, go to the **Manage** tab on the ribbon, and click **Building hierarchy**.

The defined building hierarchy and the object locations in the hierarchy are common for all users of the model. Building hierarchy is shared when using Tekla Model Sharing.

Note that if you want to use **Organizer** or user-defined attributes to define the hierarchy, set the `XS_USE_INTEGRATED_BUILDING_HIERARCHIES` advanced option to `FALSE`, save the model and reopen it to apply the change. If you had already defined a hierarchy using **Building hierarchy**, this hierarchy is not shown in **Organizer** anymore and it is not used in IFC export. Instead, IFC export uses the hierarchy defined in **Organizer** or with user-defined attributes. If you change the advanced option value back to `TRUE`, the hierarchy defined with **Building hierarchy** is again shown in **Organizer** and it is used in IFC export.

2.1 Building hierarchy elements

Building hierarchy can have the following hierarchy structure: project > site > building > building section > building storey > space. When you select a building hierarchy element, the element is always selected in both the **Building hierarchy** side pane and in the model, regardless of where you select it.

- **Project** does not have a representation in the model. You can define the properties of the project in **File** --> **Project properties**.
- **Site** does not have a representation in the model. A site is a defined area of land for construction work. You can have one site in the building hierarchy, and define the properties of the site in the property pane.

- **Building** is represented as a spatial volume in the model. The boundaries of the volume can be displayed as wireframe or shaded wireframe.

You can have multiple buildings in your model. A building can have multiple building sections and building storeys.

- **Building section** is represented as a spatial volume in the model. Building section is a representation of a specific portion of a building. The boundaries of the volume can be displayed as wireframe or shaded wireframe.

You can add several building sections in a building.

- **Building storey** is represented as a horizontal plane at a specified elevation within a building or a building section. Building storey is a horizontal subdivision of a building or a building section, defined by its level within the structure. The boundaries of buildings or building sections also define the boundaries for building storeys, depending on where the building storey is created.

You can add multiple building storeys in a building and a building section.

Objects are automatically assigned to building hierarchy elements based on the center point of the object geometry, with the exception of column and panel type objects, which are assigned to hierarchy elements based on the center point of their bottom edge. A building storey includes those objects that have their center point of geometry within the space between the elevation of the storey and the elevation of the next storey above.

- **Space** is represented as a spatial volume in the model. The boundaries of the volume can be displayed as wireframe or shaded wireframe.

Spaces define bounded areas or volumes that provide for certain functions, such as rooms, halls, or corridors within a building.

A space is automatically assigned to the closest building storey below it. The created spaces are listed in the **Building hierarchy** side pane under the building storeys they are assigned to. If there are no building storeys, spaces are assigned either to the site, building, or building section element.

2.2 Create a building hierarchy in the model

Create a hierarchy for the spatial structure of a building. The hierarchical structure follows the IFC spatial structure: project > site > building > building section > building storey > space.

1. On the **Manage** tab on the ribbon, click **Building hierarchy**.
The **Building hierarchy** side pane opens. Project and site are automatically created when the model is created. You cannot create them yourself in the hierarchy.

2. In the **Building hierarchy** side pane, click the  button.

3. Click the **Create building** command.

- a. Pick the first boundary point for the building in the model.
- b. Pick the second boundary point for the building.
- c. Pick the next boundary point for the building.
- d. Click the middle mouse button to create the building.

You can now continue by creating more buildings if you have more than one building in your model.

- e. To create another building, pick another point.
- f. To stop creating buildings, press **Esc**.

When you have finished creating buildings, you can continue by creating building sections, buildings storeys, and spaces:

- If you need building sections, use the **Create building section** command to create building sections in the building you created.
- If there is no need for building sections in the building, you can use the **Create building storey** command to create building storeys in the building.
- If there is no need for building storeys, you can use the **Create space** command to create spaces in the building.

4. Click the **Create building section** command.

- a. Pick the first boundary point for the building section in the model.
- b. Pick the second boundary point for the building section.
- c. Pick the next boundary point for the building section.
- d. Click the middle mouse button to create the building section.
- e. To create another building section, pick another point.
- f. To stop creating building sections, press **Esc**.

5. Click the **Create building storey** command.

- a. Select a building or a building section.
 - b. Pick a point at the building storey elevation in the model, or enter the elevation in the property pane, and then click the **Insert building storey**  button in the property pane.
 - c. To create another building storey, pick another point.
 - d. To stop creating building storeys, press **Esc**.
6. Click the **Create space** command.
 - a. Pick the first boundary point for the space in the model.
 - b. Pick the second boundary point for the space.
 - c. Pick the next boundary point for the space.
 - d. Click the middle mouse button to create the space.
 - e. To create another space, pick another point.
 - f. To stop creating spaces, press **Esc**.

The hierarchy is shown in the **Building hierarchy** side pane.

2.3 Import a building hierarchy from a reference model

You can import a building hierarchy when both the reference model and the Tekla Structures model contain one building each. The building storeys and spaces of the imported reference model will replace the building storeys and spaces of the Tekla Structures building.

1. If the reference model from which you want to import the building storeys and spaces is already in your model, go to step 4.
To insert a reference model to your model, click **File --> Import --> Insert reference model**.
2. In the **Add model** dialog, click **Browse** to select the reference model from the list.
3. Click **Add model**.
4. On the ribbon, click **Manage --> Building hierarchy** to open the **Building hierarchy** side pane.
5. Click the  button in the upper right corner of the **Building hierarchy** side pane.
6. Click the **Import from reference model** command.
7. Select the reference model from which you want to import the hierarchy.

You can enter characters in the **Reference model name** box to get a list of the available reference models that contain the entered character.

Alternatively, you can select the model from the **Reference models** side pane, or from the model. If you select from the model, ensure that the **Select reference models** selection switch is active.

The name of the reference model that you select is shown in the **Reference model name** box.

8. Select the lowest level that is imported from the building hierarchy, either building storey or space.
9. Click **Import**.

If the model already has a building hierarchy, Tekla Structures displays a dialog about replacing the existing hierarchy.

If you click **Replace**, the building storeys and spaces are replaced as follows:

- If you have selected **Building storey** in **Lowest level to import from building hierarchy**, building storeys will be replaced with the imported building storeys.
- If you have selected **Space** in **Lowest level to import from building hierarchy**, both building storeys and spaces will be replaced with the imported building storeys and spaces.

The imported building storeys and spaces are shown in the **Building hierarchy** side pane. To have them visible in the model, ensure that **Building hierarchy** is selected in the display settings. Double-click anywhere on the model background, then in the **View properties** dialog, click **Display...** and check that **Building hierarchy** is selected.

If you clear the **Building hierarchy** checkbox in the display settings, and click **Modify**, the imported building storeys and spaces are still shown in the model. Use the **Redraw view** command to update the view.

2.4 Modify the properties of building hierarchy elements

Tekla Structures shows the properties of the selected building hierarchy element in the property pane. If you do not have the property pane open,

click the  button in the side pane to show the properties.

Modify the properties in the property pane as needed. When you have finished modifying, click the **Modify** button to apply the changes.

Property	Description
Name	The name can contain a maximum of 61 characters.
Boundary box	Use the elevation and offset properties to define the bounding

Property	Description
	<p>volume of the building hierarchy elements.</p> <ul style="list-style-type: none"> • Building and Building section: <ul style="list-style-type: none"> • The side boundaries are the boundaries that you pick in the model when creating the building or building section. • Use the Top elevation and Bottom elevation properties to define the top and bottom boundaries. • Building storey: <ul style="list-style-type: none"> • The side boundaries are defined by the boundaries of buildings or building sections, depending on where the building storey is created. • The top and bottom boundaries are defined by the Elevation property, from the elevation of the building storey to the elevation of the next building storey above. <p>If you change the elevation of a building storey that has objects assigned to it, Tekla Structures displays a dialog where you need to select whether to move the building storey only, or the building storey and the objects assigned to it.</p> • Use the Bottom offset property to define a certain distance below the storey. You can assign objects that are below the elevation of a building storey to that particular building storey. For example, if you set the bottom offset to 300 mm, the objects that are 0-300 mm below the elevation of the building storey are also assigned to that building storey.

Property	Description
	<ul style="list-style-type: none"> • Offset is the distance from the top surface of the load-bearing structure to the top surface of the finished floor. • Space: <ul style="list-style-type: none"> • The side boundaries are the boundaries that you pick in the model when creating the space. • Use the Bottom offset property to define a certain distance below the space.
IFC entity	<p>Site, building, building section, building storey, and space all have the IFC entity property. You can only modify the IFC entity of spaces.</p> <ol style="list-style-type: none"> 1. Select the IFC entity value: <ul style="list-style-type: none"> • <code>IfcSpace</code>, the space is exported. This is the default value. • <code>None</code>, the space is not exported. • <code>Auto</code>, the default value is used. 2. Select the Subtype (IFC4) value for <code>IfcSpace</code>. The default subtype is <code>NOTDEFINED</code>. 3. Define the User-defined type (IFC4) value. To do this, set Subtype (IFC4) to <code>USERDEFINED</code>.

2.5 Assign objects to building hierarchy elements

You can manually assign objects to desired building hierarchy elements. For example, columns that span over several storeys might not be automatically assigned to the desired building storey.



To	Do this
Assign objects manually to a building hierarchy element	<ol style="list-style-type: none"> 1. On the Selecting toolbar, switch on the selection switch for assemblies and cast units  . 2. Select the objects in the model. You can assign one or more objects at a time. The objects can be located outside the building hierarchy element. 3. Right-click and select Building hierarchy --> Assign selected objects to. 4. Select the building hierarchy element to assign the objects. <p>If you want to restore the automatic assignment of objects, select the objects again. Right-click and select Building hierarchy --> Restore default assignment for selected objects.</p>
Show, select, and hide objects assigned to building hierarchy elements	<ol style="list-style-type: none"> 1. Select a building hierarchy element in the Building hierarchy side pane. 2. Right-click and select one of the following: <ul style="list-style-type: none"> • Show assigned objects Displays all assigned objects that are currently hidden and ensures that all assigned objects are visible. • Select assigned objects Highlights and selects all assigned objects. • Hide assigned objects Hides all assigned objects. • Show only assigned objects Displays only the assigned objects and hides all others.

To	Do this
	3. To return to the original view, right-click the view and select Redraw view .

2.6 View and filter building hierarchy elements

You can control the visibility and rendering of the building hierarchy elements in the model. You can hide and delete the elements, and report space properties.

View building hierarchy elements in the model

To	Do this
Set the visibility of building hierarchy in the model	<ol style="list-style-type: none"> 1. Double-click anywhere on the model background to open the View properties dialog. 2. Click the Display... button to open the Display dialog. 3. Select or clear the Building hierarchy checkbox. 4. Click Modify.
Change the rendering of building hierarchy elements	<ol style="list-style-type: none"> 1. On the View tab, click Rendering. 2. Select the rendering option that you want to use: <ul style="list-style-type: none"> • Building hierarchy wireframe  • Building hierarchy shaded wireframe 

Inquire and filter building hierarchy elements

To	Do this
View to which building storey an assembly is assigned to	<p>Inquire an assembly in the model.</p> <p>The building hierarchy information is shown in the result.</p>

To	Do this
Filter building hierarchy objects	Use the Location breakdown structure category to filter building hierarchy objects based on their location.

Report properties of spaces

To	Do this
Report space object properties for assemblies and cast units	Use the <code>SPACE</code> template attributes to report the properties.

2.7 Create views on selected building storeys

You can create model views of the building storeys that you select in the **Building hierarchy** side pane or in the model.

1. On the **View** tab, click **New view** --> **On selected building storeys**.
2. Select building storeys in the **Building hierarchy** side pane or in the model.
3. In the **Create views on selected building storeys** dialog, define the view name, and select the view properties.
4. Select whether the view is created at the building storey offset.
5. Click **Create**.

The created views are listed in the **View list**. On the ribbon, go to the **View** tab and click **View list**.

2.8 Example: Building hierarchy in Organizer

You can use [Organizer \(page 7\)](#) to view the building hierarchy that you have defined.



1. On the ribbon, click **Manage** --> **Building hierarchy** to open the **Building hierarchy** side pane.
2. On the **Manage** tab, click **Organizer**.
3. Select **Synchronize** in the dialog that opens to get the building hierarchy to **Organizer**.

The building hierarchy is shown at the top part of the **Categories** section and it has a green icon .

When you make changes in the **Building hierarchy** side pane, you need to synchronize **Organizer** to get the changes to **Organizer**.

4. If needed, you can manually make changes in the building storeys, for example, move assemblies to another building storey.

Select the assembly in the model, then right-click the target building storey in **Organizer**, and click the **Move the selected objects** command. Synchronize **Organizer**.

You can remove the changes that you have manually made. Select the category, click  and select **Manage manual changes**. Select the manually added objects marked with  or , right-click and select **Remove manual changes**. Synchronize **Organizer**.

NOTE When you are using **Building hierarchy** in your model, IFC export uses the building hierarchy storeys when the **Spatial hierarchy from Organizer** setting is selected in the **Export IFC** dialog. Spaces are also exported when you select the **Spaces** object type in the **Export IFC** dialog. Note that the hierarchies created in **Organizer** cannot be used at the same time.

To use the hierarchies created in **Organizer** in the IFC export, set `XS_USE_INTEGRATED_BUILDING_HIERARCHIES` to `FALSE`.

3 Task Manager

Task manager is a tool for contractors, sub-contractors, and project managers. **Task manager** allows you to incorporate time-sensitive data into 3D Tekla Structures models and to control the schedule at various stages and levels of detail throughout the project.

With **Task manager**, you can create, store and manage scheduled tasks, and link the tasks to their corresponding model objects. On the basis of the tasks, you can create customizable model views and comprehensive 4D simulations of the progression of the project.

You can create tasks in **Task manager** or import tasks from external project management tools such as Microsoft Office Project or Primavera P6. The import functionality allows you to preserve any schedules that you have created outside the model environment, and thereby maintain schedule intelligence and organization. You can supplement imported schedules with more detail in **Task manager**.

The above workflow matches what can be found in a normal project delivery - an increasing awareness of activities that support higher level project objectives and milestones. **Task manager** gives you a logical storage space for this information, and helps you extend schedule control into powerful 3D representations.

See also

[Task manager user interface \(page 139\)](#)

[Create a task in Task manager \(page 143\)](#)

[View and filter tasks in Task manager \(page 155\)](#)

[Import and export tasks and task types in Task manager \(page 158\)](#)

[Print a task schedule from Task manager \(page 160\)](#)

[Example: Visualize a Task manager schedule in the model \(page 161\)](#)









3.1 Task manager user interface

Task manager lists all the tasks included in the current Tekla Structures model and shows the timescale of your project.

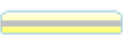
To open **Task manager**, click **Manage** on the ribbon and then click **Tasks**.

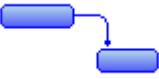
The tasks and task properties are shown as a task list in a table. **Task manager** contains a set of default tasks that depend on the Tekla Structures environment. The default tasks contain the recommended settings. You can modify and delete the default tasks.







The Gantt chart shows the timescale of the project using the following symbols:



Symbol	Description
	The task is not linked to any model object.
	The task has planned start and end dates.
	The task has actual start and end dates.
	Shows the completeness of the task.
	The task is a summary task. Summary tasks can contain other summary tasks as subtasks.
	Shows the dependency between tasks.
	Shows a milestone.
	The task is locked. The task is marked as locked  in the task list.

Modify your Task manager view

You can modify the **Task manager** view to show the relevant task properties and the timescale.

To open **Task manager**, click **Manage** on the ribbon and then click **Tasks**.

To	Do this
Show or hide the tasks	<p>Click  > Task List.</p> <p>A check mark <input checked="" type="checkbox"/> in front of Task List indicates that the task list is shown.</p>
Show or hide the Gantt chart	<p>Click  > Gantt Chart.</p> <p>A check mark <input checked="" type="checkbox"/> in front of Gantt Chart indicates that the Gantt chart is shown.</p>
Show or hide a task property in the task list	<ol style="list-style-type: none"> 1. Click  > Task List Items. 2. Select a task property to show or hide it. <p>A check mark <input checked="" type="checkbox"/> in front of the property indicates that the property is shown.</p> <p>When you open Task manager the next time, the selections you made in the previous Task manager session are in use.</p>
Show or hide a task property in the Gantt Chart	<ol style="list-style-type: none"> 1. Click  > Gantt Chart Settings. 2. Select a task property to show or hide it. <p>Note that you must have the actual start and end dates defined for a task to show them in the Gantt chart.</p> <p>A check mark <input checked="" type="checkbox"/> in front of the property indicates that the property is shown in the Gantt chart.</p>
Change how dates and time are shown in Task manager	<ol style="list-style-type: none"> 1. Click  > Date and time format. 2. Select the format that you want to use. <p>The default format in Task manager shows the dates and time as set in the Windows regional and language settings.</p>
Change the Gantt chart timescale	<ol style="list-style-type: none"> 1. Click . 2. Select a timescale option. <p>Fit to the project automatically selects the appropriate timescale option to show the whole project schedule in the Gantt chart.</p> <p>You can also change the timescale by dragging the mouse on the Gantt chart. Hold down the right mouse button and drag the mouse to the left to make the timescale narrower, and to the right to make the timescale wider.</p>

To	Do this
Zoom in the Gantt chart	<ul style="list-style-type: none"> To zoom to a task in the Gantt chart, select a task in the task list and press Ctrl + 1. To zoom to the whole scenario, press Ctrl + 2. To place the Gantt chart symbol of the selected task in the middle of the chart, press Ctrl + 3.
Change the size of the buttons in Task manager	Click  > Large icons .
Change the colors of Gantt chart symbols	<ol style="list-style-type: none"> Click  > Set Colors. Click the color you want to change. Select a color. Click OK.
Keep the Task manager dialog on top of other windows on your screen	Click  > Stay on top .



Modify the calendar in Task manager

Task manager has a calendar that is used when calculating the task length. You can modify the calendar by adding, modifying and removing holidays and other non-working periods.

Non-working periods change the task duration automatically but they do not change the planned or actual end dates of a task. This means that the workload of the task may change. For example, adding an extra non-working day for a one-week task changes the duration from 5 to 4 days increasing the workload of one day. Weekends are by default non-working periods.

To open **Task manager**, click **Manage** on the ribbon and then click **Tasks**.

To	Do this
Set the length of the working day	<ol style="list-style-type: none"> Click  > Non-working Periods... Type the working hours in the From and To boxes. Click Set working day. Click OK.

To	Do this
Add non-working periods to the calendar	<ol style="list-style-type: none"> 1. Click  > Non-working Periods.... 2. Click Add. 3. Type a descriptive name in the Name box. 4. Select the Start date and the End date. 5. Set the Recurrence frequency to non-recurring, weekly or yearly. 6. Set the Range of recurrence for recurrent non-working periods. 7. Click OK. <p>To modify a non-working period, select a period in the Non-working Periods dialog and click Modify.</p> <p>To delete a non-working period, select a period in the Non-working Periods dialog and click Remove.</p>
Import a holiday file from Microsoft Outlook	<ol style="list-style-type: none"> 1. Click  > Non-working Periods.... 2. Click Import Holidays.... 3. Browse for the holiday file. 4. Select the country from the list. 5. Click OK.
Import a calendar	<p>You can import a calendar from Microsoft Project, for example.</p> <hr/> <p>NOTE The imported calendar overrides the existing calendar in Task manager.</p> <hr/> <ol style="list-style-type: none"> 1. Click  > Import.... 2. Browse for the file to import. 3. Select the Import calendar option. 4. Click OK.

3.2 Create a task in Task manager

You can create scheduled tasks in **Task manager** and link the tasks to the relevant model objects. Each task must have at least a name, and a planned start date and end date. The tasks in **Task manager** are saved when you save the Tekla Structures model.

You can create a task both in the model and in **Task manager**. To open **Task manager**, click **Manage** on the ribbon and then click **Tasks**.

- In the model, select one or more model objects, then right-click and select **Task --> Create task**.

The task is automatically linked to the selected model objects.

- In **Task manager**, click .

If you have an existing task selected in **Task manager**, the properties of the selected task are used in the new task. You can modify the properties. The new task is not linked to any model objects yet.

You can create subtasks for a task by clicking .

If the task you created is not shown in **Task manager**, click anywhere on the tasks to update the view.

When you have created a task, you can add objects to the task to link the task to the model, and define the task properties. You can modify the task properties either in the task list or in the **Task Information** dialog. Note that you can modify some of the properties in the **Task Information** dialog only.

TIP You can lock tasks if you want ensure that task properties are not unintentionally changed. Select a task, right-click and select **Lock task**.

Locked tasks are marked with a lock  in the task list.





You can lock one or more tasks at one go. If you select several tasks, and one or more of the tasks, but not all of them, are already locked, **Task manager** shows  in front of the **Lock task** command.

Link a task to the model

Tasks are linked to the model through the objects that are included in the tasks. You can add objects to a task, copy objects from one task to another, and remove objects from a task.

To open **Task manager**, click **Manage** on the ribbon and then click **Tasks**.

To	Do this
Add objects to a task	<ol style="list-style-type: none"> 1. In the model, select the objects that you want to add to the task. 2. Do one of the following: <ul style="list-style-type: none"> • Right-click and select Task --> Add to selected task. • In Task manager, right-click the selected task and click Add Selected Objects.

To	Do this
	<p>When you have added the objects to the task, Task manager changes the color of the task bar to blue in the Gantt chart</p>  <p>and selects the Task linked to model checkbox <input checked="" type="checkbox"/> in the task list.</p>
Copy objects from one task to another	<p>You can copy objects from one task to another in Task manager. If you want to move all the objects of a task to another task, you must manually remove the objects from the original task after the copying.</p> <ol style="list-style-type: none"> 1. Select the task from which you want to copy the objects. 2. Click  to automatically select the objects in the model to check which objects are linked to the task. The button changes to  when it is activated. 3. Right-click the selected task and select Keep selection. All objects linked to the task stay selected. 4. Select the task you want to copy the objects to. 5. Right-click and select Add selected objects.
Remove objects from a task	<ol style="list-style-type: none"> 1. Select the task from which you want to remove the objects. 2. Click  to automatically select the objects in the model. You can remove all objects from the task, or select which objects are removed. If you do not select any objects, all objects are removed from the task. 3. To remove all the objects from the task: <ul style="list-style-type: none"> • In the model, right-click and select Task --> Remove from selected task . • In Task manager, right-click the selected task and click Remove Selected Objects. 4. To remove some objects from the task: <ul style="list-style-type: none"> • In Task manager, right-click the selected task and select Task Information... --> Objects . Select the objects you want to remove and press the Delete key. • In the model, select the objects you want to remove, right-click and select Task --> Remove from selected task .

To	Do this
	5. Click the view in the model, and then click the task again in Task manager to verify that the objects were successfully removed.

Define a task type

You can define task types for different types of tasks. In the task type, you can define a production rate and user-defined attributes that are linked to the objects in the task. You can define task types in advance before creating the tasks, and then select an appropriate task type when defining the task properties.

1. To open **Task manager**, click **Manage** on the ribbon and then click **Tasks**.

2. Click  > **Task Types....**

3. Click **Add**.

4. Type a name for the task type.

5. Define a production rate for the task type.

The production rate is used when calculating task duration. Using the production rate, you can define how many units are produced within a certain time frame, for example, how many pieces per hour or how large an area in an hour, 1.50 pcs/hour or 8.00 m²/hour. **Task manager** automatically calculates the production rate when you define the unit, quantity, and time.

- a. Select a unit in the **Unit** list.

The default unit is `PIECES`.

The default task type units are report properties that are listed in the `WorkTypeProperties.xml` file. The file is located in the model folder and it is created when you first open **Task manager**. The report properties included in the file depend on the Tekla Structures environment. To change a task type unit or to add new task types, edit the `WorkTypeProperties.xml` file.

You can add Tekla Structures report properties, reference model properties and calculations to the file. The display name defined in the file is shown in the **Unit** column and the report property name value is used in **Task manager**. If you are adding a calculation, the property type must be `calc`.

The default units of the task type units depend on the settings in **File --> Settings --> Options --> Units and decimals**.

- b. Type the quantity in the **Quantity** box.
- c. Type the time in the **Time** box.

6. Select the planned dates user-defined attributes which are linked to the objects in the task.
7. Click **OK**.

Define a contractor in Task manager

You can define contractors and assign one contractor for a task.

1. To open **Task manager**, click **Manage** on the ribbon and then click **Tasks**.
2. Click  > **Contractors....**
3. Click **Add**.
4. Type the contractor name.
5. Click **OK**.

Define general task properties

You can define general properties for a task, such as a name, task type, and contractor.

1. To open **Task manager**, click **Manage** on the ribbon and then click **Tasks**.
2. Select a task in the task list.
3. Right-click and select **Task Information....**
4. Ensure that you are on the **General** tab.
5. Type the task name in the **Task name** box.
6. Select the **Milestone** checkbox if you want to mark the task as a milestone.

Task manager selects this checkbox automatically if you set the task length to zero.



7. Select how the task is moved in the Gantt chart if it has a dependency with another task:
 - **Only forward** moves the dependent task forward only when the preceding task is moved forward. If the preceding task is moved backward to an earlier date, the dependent task is not moved.
 - **Forward and backward** moves the dependent task in the same direction as the preceding task, according to the dependency type and the possible lag time.
8. Select a task type from the **Task type** list.

If you need to add a new task type, click  next to the list and click **Add**. Define the task type properties and click **OK**.

9. Select a contractor from the **Contractor** list.

If you need to add a new contractor, click  next to the list and click **Add**. Type the contractor name and click **OK**.

10. Click **OK**.

-
- TIP**
- You can copy property values in the task list. Right-click a property and select **Copy value**. Then select another property, right-click and select **Paste value**. You can paste the copied value to multiple tasks.
 - You can mark several tasks as milestone tasks at one go. Select the tasks in the task list, right-click and select **Milestone task**. Milestone tasks are shown in the Gantt chart with the milestone symbol  .
- If you select several tasks, and one or more of the tasks, but not all of them, are already milestone tasks, **Task manager** shows  in front of the **Milestone task** command.
-

- TIP** You can set a default value for how dependent tasks are moved. Click  > **Task Settings...** to select the value. The default value is used in all new tasks.
-

Define a task schedule

You can plan a schedule for a task. You can define both the start and the end date, or enter the start date and the task length and let **Task manager** calculate the end date.

1. To open **Task manager**, click **Manage** on the ribbon and then click **Tasks**.
2. Select a task in the task list.
3. Right-click and select **Task Information....**
4. Go to the **Scheduling** tab.
5. Select the **Scheduling mode**:
 - **Fixed start and end**

If you add objects to the task or remove objects from the task, the production rate changes but the task length does not change.
 - **Fixed start**

If you add objects to the task or remove objects from the task, the task length changes.
6. Select the **Planned start date**.
7. Select the **Planned end date** or enter the **Planned length** of the task.

The planned length is shown in shifts that can be working days, for

example. Go to  > **Non-working Periods...** to define a working day. When you enter the planned length, **Task manager** calculates the end date for the task.

If you are using the **Fixed start** scheduling mode, you can enter the task length in **Planned work duration**.

Task manager automatically calculates the total workload, production rate, and work duration of the task.

8. Click **OK**.

TIP You can set a default value for the scheduling mode. Click  > **Task Settings...** to select the value. The default value is used in all new tasks.

TIP You can also modify the length of the task in the Gantt chart. Place the mouse pointer over the edge of the task bar in the Gantt chart. The mouse pointer changes into a double-ended arrow. Hold down the left mouse button, and then drag the edge to the right or to the left.

To check that the dates of subtasks are within the summary task dates, click

 > **Check Dates**. The conflicting dates are shown in red.

Manage the planned dates of objects in a task

You can manage the planned duration of the activities related to each object in a task.

1. To open **Task manager**, click **Manage** on the ribbon and then click **Tasks**.
2. Select a task in the task list.

Ensure that there are objects in the task and that you have defined task types that are linked to the appropriate user-defined attributes for planned dates.

3. Right-click and select **Task Information....**
4. Go to the **Objects** tab.

5. Click the  function button to calculate the planned dates for the objects in the task.

The calculated dates are written to the corresponding user-defined attributes in the object properties.

6. Click **OK**.

TIP To calculate the dates for several tasks at one go, select the tasks in the task list and click .

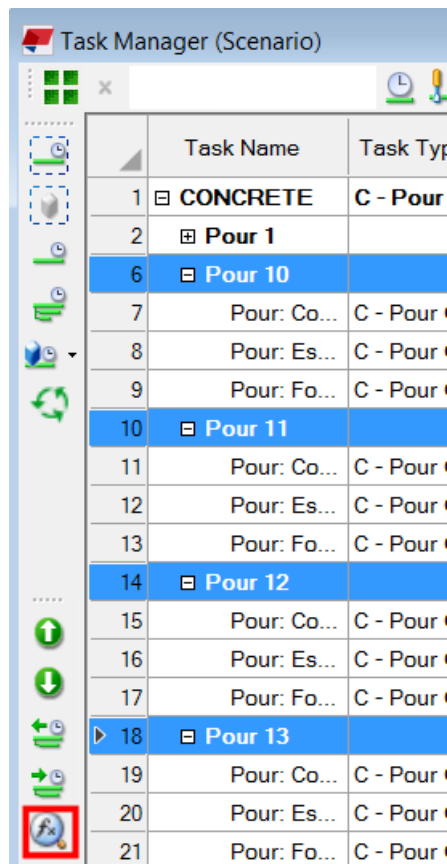

Track a task schedule

You can track how a task is progressing by defining the actual schedule and task completeness information.

1. To open **Task manager**, click **Manage** on the ribbon and then click **Tasks**.
2. Select a task in the task list.
3. Right-click and select **Task Information....**
4. Go to the **Tracking** tab.
5. Select the **Completeness tracking** mode:
 - **Automatic**

If there are no objects in the task, **Automatic** works in the same way as the **Task level** tracking mode.

If there are objects in the task, **Automatic** works in the same way as the **Object level** tracking mode.

- **Task level**

Define the actual schedule and the task completeness for the task in **Task manager**.

- **Object level**

Define the actual start and end date of individual objects in the object properties in the model. **Task manager** calculates the task length and the task completeness.



When you change the dates of an object in the model, refresh the task in **Task manager** to ensure that the changed dates are shown in **Task manager**.

6. Click **OK**.

TIP You can set a default value for the completeness tracking property. Click  > **Task Settings...** to select the value. The default value is used in all new tasks.

Define the order of objects in a task

You can define and save the order in which objects are stored in a task.

1. To open **Task manager**, click **Manage** on the ribbon and then click **Tasks**.
2. Select a task in the task list.
3. Right-click and select **Task Information....**
4. Go to the **Objects** tab.
5. Set the sequencing order of objects:
 - a. Click  to select all objects in the table, or select the objects that you want to modify.
 - b. Click .

The **Sequencing order** column shows the order of the objects.

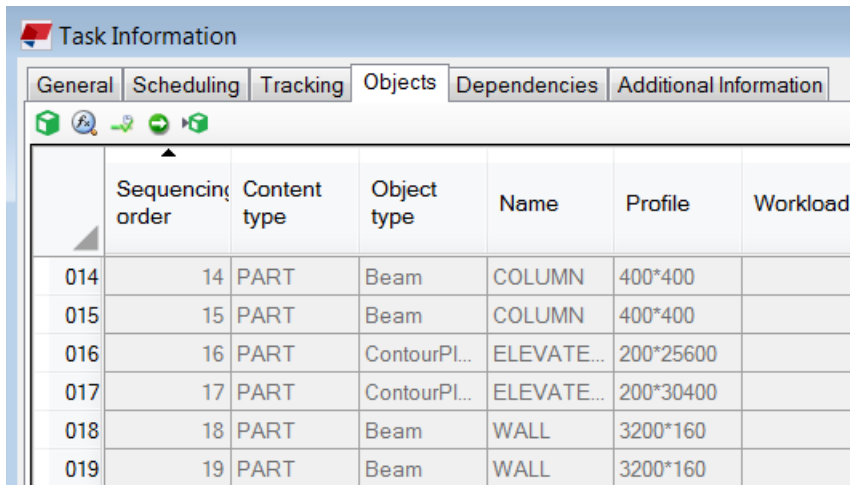

	Sequencing order	Content type	Object type	Name	Profile	Workload
014	14	PART	Beam	COLUMN	400*400	
015	15	PART	Beam	COLUMN	400*400	
016	16	PART	ContourPL...	ELEVATE...	200*25600	
017	17	PART	ContourPL...	ELEVATE...	200*30400	
018	18	PART	Beam	WALL	3200*160	
019	19	PART	Beam	WALL	3200*160	

You can also set the sequencing order by selecting the objects in the desired order in the model. Select objects in the table, click  and select the objects in the model in the desired order.

6. If needed, change the order of the objects in the table:
 - Drag the object rows in the table manually to the desired order.
You can drag several object rows at a time.
 - Click a table column heading to sort the objects.
Press **Ctrl** and select more than one column heading to sort the objects by several columns.
7. Click **OK**.

TIP You can show a sequence in the model.

1. Select the objects in the table.
2. Type the speed of the object selection in seconds in the box next to the **Play**  button.

For example, if you enter 2, Tekla Structures waits for 2 seconds until it selects the next object in the sequence.

3. Click .

The objects are selected in the model in the same order as they are on the **Objects** tab. The objects stay selected in the model until you click somewhere in the model.

TIP To show the order information in the model, select one or more objects in the table and click  or press **Ctrl + D**. The order information is shown on the

selected objects in the model. For example, 2-1 means that the object belongs to the second task in the task list and that the object is the first object in the task.

To clear the numbers from the model, right-click and select **Update window**.

When you define the cast-in-place work order or work groups within a task, you can use **Organizer** for [planning the appropriate quantities \(page 69\)](#) for each group or lot.

Define a dependency between tasks

You can define different types of dependencies between tasks in **Task manager**. You can define a dependency for one task at a time.

The dependencies are represented by arrows in the Gantt chart. The arrow points to the start or the end of the other task, depending on their relationship. A task can also be dependent on a milestone.



A predecessor is a task that must be completed before the dependent task. You can also define a lag between the tasks, for example, that Task1 must be completed five days before Task2 can be started. It is not possible to create circular dependencies in **Task manager**.

To define a dependency between tasks:

1. To open **Task manager**, click **Manage** on the ribbon and then click **Tasks**.
2. Select a task in the task list.
3. Right-click and select **Task Information....**
4. Go to the **Dependencies** tab.

If you have more than one task selected, the **Task Information...** tab is not shown.

5. Select the preceding task from the **Task name** list.

You cannot select the summary task of the current task, or a task that already has a dependency with the current task.

6. Select a dependency type from the **Type** list. The options are:

- **Finish-to-Start (FS)**: The preceding task must finish before the dependent task can start.

You can also drag a task bar onto another task bar in the Gantt chart to create a basic **Finish-to-Start (FS)** dependency with no delay days between the tasks.

- **Start-to-Start (SS)**: The preceding task must start before the dependent task can start.

- **Finish-to-Finish (FF):** The preceding task must finish before the dependent task can finish.
 - **Start-to-Finish (SF):** The preceding task must start before the dependent task can finish.
7. If you want to add a delay between the tasks, enter a value in the **Lag** list. Define the value on a scale from 1 to 100. The time unit of the delay is always **days**.
 8. If needed, go to the **General** tab and check that the **Move with predecessor** setting for how tasks are moved in the Gantt chart is suitable.
 9. Click **OK**.

TIP You can also modify a dependency in the Gantt chart. Right-click a dependency arrow and do any of the following:

- Select a dependency from the list.
- Enter a new lag value and press the **Enter** key.

The changes are immediately visible in the Gantt chart.

Define additional information for a task

You can define additional information for a task in **Task manager**, such as links to web pages, relevant documents, project schedules, and contracts.

1. To open **Task manager**, click **Manage** on the ribbon and then click **Tasks**.
2. Select a task in the task list.
3. Right-click and select **Task Information....**
4. Go to the **Additional Information** tab.
5. Click **Add**.
6. Select the file and click **Open**.
7. Enter additional notes in the **Notes** box.
8. Click **OK**.

Create a scenario

Tasks are included in scenarios. You can create different scenarios to define alternative workflows, for example, for design, fabrication and erection schedules to help you in project planning. You can also create separate weekly scenarios for easier project follow-up.

1. To open **Task manager**, click **Manage** on the ribbon and then click **Tasks**.

2. Click .

3. Click **Add**.

Task manager names the new scenario as **Scenario** and adds a running number to the name, for example **Scenario1**. You can rename the scenario.

4. Click **Open** to add tasks to the new scenario.

5. Click  to create a task.

6. If needed, copy tasks from another scenario.

a. Select a scenario in the list of scenarios and click **Open**.

b. Select the tasks that you want to copy.

The subtasks of the selected tasks are also copied.

c. Right-click and select **Copy** or **Copy Without Objects**.

d. Go back to the new scenario, select a location for the copied tasks in the task list, right-click and select **Paste**.

When you select a location, the copied tasks are placed on the same level as the selected task. If you do not select any location, the copied tasks are placed after all existing tasks.

TIP To modify the start dates of the whole scenario at one go, click  > **Change Project Start Date** and select a new start date.

To delete a scenario, right-click a scenario in the list of scenarios and click **Delete**.



3.3 View and filter tasks in Task manager

You can view, select, highlight and filter tasks in different ways in **Task manager**.







To open **Task manager**, click **Manage** on the ribbon and then click **Tasks**.





Select tasks

To	Do this
Select multiple tasks	Do any of the following: <ul style="list-style-type: none">• Hold down the Ctrl key and select the tasks.• Select the first task, hold down the Shift key and select the last task.



To	Do this
	<ul style="list-style-type: none"> Select the first task and drag the mouse across the tasks that you want to select.
Select multiple tasks in the Gantt chart	<p>Do one of the following:</p> <ul style="list-style-type: none"> Select an area in the Gantt chart. Drag the mouse on the header line in the Gantt chart to select a time period. <p>Task manager highlights the tasks that are within the selected area.</p>
Show only the selected tasks in the task list	<ol style="list-style-type: none"> Select one or more tasks in the task list. Click . Click  to show all tasks again.

Organize tasks in the task list

To	Do this
Change the order of tasks	<p>Select a task and click  or  until the task is in the desired location.</p> <p>You can move more than one task at a time. When you move a task, the related subtasks are also moved.</p>
Save the order of tasks	<p>Click  and select Save Current Order.</p> <p>If you change the saved order of tasks and want Task manager to show the saved order again, click  and select Return to Saved Order.</p>
Change the hierarchy of tasks	<p>Select a task and do one of the following:</p> <ul style="list-style-type: none"> To increase the hierarchy, click . You can change a task to a subtask. To decrease the hierarchy, click . You can change a subtask to a task. <p>You change the hierarchy of more than one task at a time.</p>
Expand and collapse task hierarchies	<p>Select a task and do one of the following:</p> <ul style="list-style-type: none"> Click  to collapse the hierarchy of the selected task.

To	Do this
	<p>Click  to collapse the hierarchy of all tasks that are on the same level as the selected task.</p> <p>Press Ctrl +  to collapse the hierarchy of all tasks.</p> <ul style="list-style-type: none"> Click  to expand the hierarchy of the selected task. <p>Click  to expand the hierarchy of all tasks that are on the same level as the selected task.</p> <p>Press Ctrl +  to expand the hierarchy of all tasks.</p>
Change the sorting direction	Click a column heading to change the sorting direction. To reverse the direction, click the column heading again.

View tasks in the model

To	Do this
Select the model objects of a task in the model	<p>In Task manager:</p> <ol style="list-style-type: none"> Select a task in the task list. Click .
Highlight a task in the model	<p>In the model:</p> <ol style="list-style-type: none"> Activate the Select tasks  selection switch. Place the mouse pointer over a model object. If the object belongs to a task, Tekla Structures highlights the task. <p>The green box shows the boundaries of the task in the model.</p>
View the tasks related to a model object	<p>In the model:</p> <ol style="list-style-type: none"> Ensure that the Select tasks  selection switch is not active. Select a model object. Right-click and select Task --> Show related task . <p>Task manager selects the related tasks in the task list. The model objects that belong to the related tasks are highlighted, but not selected, in the model.</p>

Filter tasks

To	Do this
Filter tasks in the task list	<p>You can filter tasks by status, contractor, task type, name, and start and end dates. You can set that the filtering shows only those tasks that are within your selection in the model.</p> <ol style="list-style-type: none">1. Click .2. Select the filters you want to use.3. Click Filter.4. Click Show all to show all tasks. <p>You can also filter tasks by entering a filter criterion in the search box in Task manager. The search covers all the task properties that are visible in the task list.</p> <hr/> <p>TIP You can create filters for tasks using the Tekla Structures selection and view filter functionality. The filters control which objects are shown in the model and which objects can be selected. When you use selection and view filters, the tasks in the current scenario are used in the filtering.</p>

See also

[Create a task in Task manager \(page 143\)](#)

[Task manager user interface \(page 139\)](#)





3.4 Import and export tasks and task types in Task manager

You can import and export tasks and task type definitions as `.xml` files in **Task manager**.

Import tasks and task types

You can import tasks and task types from external project management software to **Task manager**. For example, you can import general building schedules from Microsoft Project, and further modify them in **Task manager**.

To open **Task manager**, click **Manage** on the ribbon and then click **Tasks**.

To	Do this
<p>Import tasks (page 143)</p>	<p>You can import one task file at a time. The file can contain more than one task.</p> <ol style="list-style-type: none"> 1. Click  > Import.... 2. Browse for the file to import. 3. Select Import baseline dates to planned dates to import the baseline dates of tasks as the planned dates. By default, scheduled dates are imported to Task manager as planned dates. 4. Select how the tasks are imported to Task manager: <ul style="list-style-type: none"> • Append imported tasks to scenario adds the imported tasks at the end of the task list. • Override existing tasks replaces the existing tasks with the imported tasks. The links between the existing tasks and model objects are not modified. Task dependencies are imported. • Override selected properties of existing tasks imports task properties. When you select this option, Task manager displays a list where you can select the properties. The links between the existing tasks and model objects are not modified. Task dependencies are imported. 5. Click OK. <p>Imported tasks are marked as imported  and locked  in Task manager.</p>
<p>Import task types (page 143)</p>	<p>You can import one task type file at a time. The file can contain more than one task type.</p> <ol style="list-style-type: none"> 1. Click  > Task Types.... 2. Click Import.... 3. Browse for the file to import. 4. Select how the task types are imported to Task manager: <ul style="list-style-type: none"> • Override task types using the same name replaces the existing task types that have the same task type name as the imported task types.

To	Do this
	<ul style="list-style-type: none"> • Append imported task types adds the imported task types at the end of the task type list. <p>5. Click OK.</p>

Export tasks and task types

You can export tasks and task types from **Task manager** to external project management software.

To open **Task manager**, click **Manage** on the ribbon and then click **Tasks**.

To	Do this
Export tasks	<ol style="list-style-type: none"> 1. Click  > Export.... 2. Browse for the file to export. 3. Click Save. <p>Task dependencies are exported.</p> <p>If the tasks contain only planned dates, they are exported as scheduled dates. If the tasks contain planned dates and actual dates, the planned dates are exported as baseline dates and the actual dates as scheduled dates.</p>
Export task types	<ol style="list-style-type: none"> 1. Click  > Task Types.... 2. Click Export.... 3. Browse for the file to export. 4. Click Save.

3.5 Print a task schedule from Task manager

You can print task schedules from **Task manager**. By default, the schedule is printed from the first date to the last date that is visible in the Gantt chart.

1. To open **Task manager**, click **Manage** on the ribbon and then click **Tasks**.
2. Click  .
3. Select the suitable printing options:
 - Click **Page setup...** to modify the page settings.
 - Select **Print to the project end date** to print the whole schedule even if the end date is not visible in the Gantt chart.

- Select **Adjust to percent of normal size** or **Fit to pages** according to your needs.
4. If needed, click **Print Preview...** to view how the schedule is printed.
You can print the schedule from the **Print preview...** dialog.
 5. Click **Print...** to print the schedule.
 6. Modify the printer settings if needed.
 7. Click **Print**.

TIP You can create reports from the task information in **Task manager** and list various details about the tasks, such as the task name, task type, planned and actual dates, and task completeness.

See also

[Create a task in Task manager \(page 143\)](#)

3.6 Example: Visualize a Task manager schedule in the model

You can use the **Project Status Visualization** tool to review the task schedules created in **Task manager**.

In this example, you will first create object groups to define which tasks are shown in the model. The object groups are related to the current **Task manager** scenario. You will then create object representation settings to define how the tasks are shown in the model. Finally, you will review the task schedule using the **Project Status Visualization** tool.

1. Create object groups for tasks:
 - a. In Tekla Structures, go to the **View** tab and click **Representation**.
 - b. Click **Object group....**
 - c. In the **Object group - Representation** dialog, create an object group with the following settings:

-	(Category	Property	Condition	Value
<input checked="" type="checkbox"/>	-	Task	Planned start date	Earlier than	Review date
<input checked="" type="checkbox"/>	-	Task	Planned end date	Earlier than	Review date

- d. Enter a name for the group, for example `Completed`, in the box next to the **Save as** button, and then click **Save as**.
- e. Repeat steps 1c - d to create an object group called `Started`. Use the following settings:

-	(Category	Property	Condition	Value
<input checked="" type="checkbox"/>	-	Task	Planned start date	Earlier than	Review date
<input checked="" type="checkbox"/>	-	Task	Planned end date	Later than or equ...	Review date

- f. Repeat steps 1c - d to create an object group called `NotStarted`. Use the following settings:

-	(Category	Property	Condition	Value
<input checked="" type="checkbox"/>	-	Task	Planned start date	Later than	Review date
<input checked="" type="checkbox"/>	-	Task	Planned end date	Later than	Review date

- g. Repeat steps 1c- d to create an object group called `All`. Use the following settings:

-	(Category	Property	Condition	Value
<input checked="" type="checkbox"/>	-	Part	Name	Equals	

- h. Click **Close**.

2. Create object representation settings for tasks:

- In the **Object Representation** dialog, select the object group `Completed` from the list in the **Object group** column.
- In the **Color** column, select a color for the object group, for example blue.
- In the **Transparency** column, select a transparency setting for the object group, for example **Visible**.
- Click **Add row** to add a new row.
- Repeat steps 2a – d to define the color and transparency settings for the other object groups (`Started`, `NotStarted`, and `All`).

For example, you can use the following settings:

Object group	Color	Transparency
Completed		Visible
Started		Visible
NotStarted		90% transparent
All		50% transparent

Enter a name for the object representation settings, for example `Tasks`, and then click **Save as**.

- f. Click **OK**.

3. Review the task schedule using **Project Status Visualization**:

- In Tekla Structures, go to the **Manage** tab and click **Project status**.
- Select `Tasks` from the **Object representation** list.

- c. Click the step buttons to change the **Review date** and to view the changes in the model.

See also

[Create a task in Task manager \(page 143\)](#)

4 Phase Manager

Use **Phase Manager** to break a model up into sections.

Phases are often used to indicate erection sequences. You can create reports and views, hide and lock objects, and copy objects from other models, according to their phase number.

For example, you might have a large project which several users work on simultaneously in single-user mode. First create a basic model that includes, for example, the columns. This is phase 1. You then copy this basic model to all users.

Each user then works on a separate part of the building. When a part of the model is completed, you can copy it back to the basic model as a separate phase (phase 2, 3, etc.).

NOTE When you copy objects between models using phases, the target model must have been created using the same or a newer version of Tekla Structures as the source model. You cannot copy from a newer version to an older version.

4.1 Divide the model into phases

1. On the **Manage** tab, click **Phases**.
The **Phase Manager** dialog appears.
2. Click **Add** to create new phases.
3. Click **Set current** to make the selected phase the current phase.
From now on, Tekla Structures assigns all objects you create to the current phase. The @ character in front of the phase number indicates the current phase.
4. Divide the model into phases.

- a. To identify the phase of an object, select an object and click **Phases by objects**.
Tekla Structures selects the phase of the object.
 - b. To see which objects belong to a certain phase, select a phase from the list and then click **Objects by phases**.
Tekla Structures highlights the corresponding objects in the model.
 - c. To change the phase of one or more objects, select the objects, select a phase from the list, and then click **Modify phase**.
5. Click **OK** to save your changes.

4.2 Lock and unlock objects in specific phases

To protect model objects from being accidentally modified or deleted, you can lock them. For example, you can lock parts, bolts, welds, and reference models in a Tekla Structures model according to their phase.

When an object is locked, you cannot modify its properties or delete it. You can only change the object's user-defined attributes that do not affect numbering. If you try to modify or delete a locked object, Tekla Structures displays the following warning message:

"There are locked objects, see report. The operation could not be performed."

1. On the **Manage** tab, click **Phases**.
2. In the **Phase Manager** dialog, select the phases whose objects you want to lock or unlock.
3. Do one of the following:
 - To lock objects, click **Lock objects**.
Tekla Structures sets the user-defined attribute **Locked** to **Yes** for the objects in the selected phases.
 - To unlock objects, click **Unlock objects**.
Tekla Structures sets the user-defined attribute **Locked** to **No** for the objects in the selected phases.

NOTE Note that assemblies, cast units, and pour units are not locked.

For information on how to protect model objects from being accidentally modified in the multi-user mode, see Access rights in multi-user mode.

4.3 Define custom phase properties

You can add custom phase properties, which will appear as extra columns in the **Phase Manager** dialog.

Define the names of phase properties in the `objects.inp` file. To use phase properties in reports and templates, use the syntax `PHASE.ATTRIBUTE_NAME` in the phase property field name.

The default `objects.inp` file contains a **Phase attributes** section with syntax examples. For more information, see [Properties of the objects.inp file](#) and [Define and update user-defined attributes \(UDAs\)](#).

5 Lotting

With lots you can group assemblies for transporting to site. Lotting means that you evaluate specific model parts with respect to the number of units that can be carried by a transfer vehicle.

For example, you can calculate how many concrete truck deliveries are needed to pour the footings or slabs for a specific portion of the model. With this information, it is easier to determine area requirements and create an erection schedule.

When you define lots, you must take into account the load-carrying capacity of the vehicle, because a lot cannot exceed the maximum total load capacity. You can calculate truck load sizes based on material weights and model quantities. For most model parts, the weight is based on the size, length, and material of the part.

TIP To view the properties of a part, double-click the part, or click **Inquire object**



and select the part.

You can use lotting in conjunction with the **Sequencer** tool. For example, you can load each part of the model onto a specific truck based on the erection sequence of the part.

The basic lotting process is the same for steel and concrete parts. However, if you are using cast-in-place concrete, remember that the concrete is transported in a volumetric container (for example, in a ten-cubic-yard truck). In that case, you must calculate the weight-carrying capacity of the concrete vehicle before defining the number of lots.

5.1 Create a lot

Create lots to group assemblies for transporting to a site.

1. On the **Manage** tab, click **Lotting**.
2. Click **Properties...** to display the **Lot Properties** dialog.

3. Enter a lot number in the **Number** box.
4. Enter a name in the box at the bottom of the dialog.
5. Enter the maximum weight of the lot in the **Max weight** box. The units depend on the settings in **File menu --> Settings --> Options --> Units and decimals**.
6. Click **Add**.
Tekla Structures creates an empty lot with the defined properties.
7. Repeat the steps from 3 to 6 to add more lots.

TIP You can modify a lot name later if needed. In the **Lotting** dialog, click **Properties....** Select the lot that you want to modify. Then modify the name in the box below the list of lots, and click **Modify**.

5.2 Add parts to a lot

After you have created the needed lots, you must select each part of the model and assign them to a lot until the total load weight of the lot reaches the specified target.

1. On the **Manage** tab, click **Lotting**.
2. Select an existing lot from the list.

Tekla Structures highlights the parts included in the lot. The total weight of the lot and the number of assemblies it contains are displayed under **Applied values**.

3. Hold down **Shift** and select the parts that you want to add to the lot.
4. Click **Apply selected**.

The weight and the number of added parts are displayed under **Current values**. Tekla Structures displays a warning message if the weight limit of the lot is exceeded.

5. Click **OK** to close the dialog.

When you re-open the dialog, the **Applied values** include the weight and the number of parts you added.

WARNING Parts can belong only to one lot at a time. If you add parts that are already in another lot, the parts will be removed from that lot.

5.3 Remove parts from a lot

1. On the **Manage** tab, click **Lotting**.

2. Select an existing lot from the list.
Tekla Structures highlights the parts included in the lot.
3. Hold down **Ctrl** and select the parts that you want to remove from the lot.
If you want to remove all the parts from the lot, click somewhere in the model without holding down **Ctrl**.
Tekla Structures deselects the parts.
4. Click **Apply selected**.
5. Click **OK** to close the dialog.

5.4 Delete a lot

1. On the **Manage** tab, click **Lotting**.
2. Click **Properties...**
3. Select an existing lot from the list.
4. Click **Delete**.

6 Sequencer

Use the **Sequencer** tool to create sequences and to assign incremental numbers to parts.

You can define several sequences for different purposes, and a part can belong to several sequences at the same time. For example, you can create erection sequences to define the order in which to erect parts.

Sequencer works by assigning a sequence number to a user-defined attribute (UDA) of a part. If you want to view and modify the sequence numbers afterwards, you must first create a new user-defined attribute to which you assign the sequence numbers.

Limitations

Sequencer does not work for objects that are inside a reference model.

6.1 Create a sequence

1. First, create a user-defined attribute (UDA) to which you assign sequence numbers.

In the file, search for the `Part attributes` section to add a new user-defined attribute (UDA). The `value_type` must be `integer`, and the `field_format` must be `%d`.

For example:

```
attribute("SEQUENCE_1", "Sequence 1", integer, "%d", no, none, "0.0", "0.0")
```

2. In Tekla Structures, go to the **Manage** tab and click **Sequencer**.

The **Sequencer Properties** dialog opens.

3. In **Sequence name**, enter the name of the sequence. The sequence name has to be exactly the same as the name of the UDA defined in the `objects.inp` file.

For example, `SEQUENCE_1`.

4. Click **Apply**.
5. Select the parts you want to include in the sequence.

The first part gets the sequence number 1, the second part number 2, and so on.

The **Sequencer Properties** dialog lists the sequences that you have entered in the **Sequence name** box. **Max number** shows the highest number that is in use in the selected sequence.

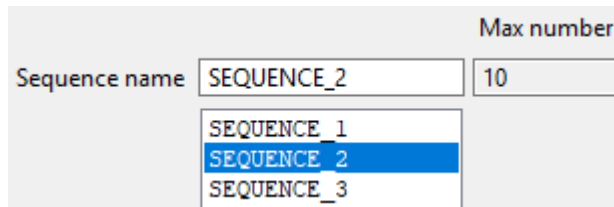

If you select a part that has already been included in the sequence, Tekla Structures asks if you want to override the existing number. If you click **Yes**, Tekla Structures gives the next available number to the part.

6. To finish adding parts to the sequence, right-click and select **Interrupt** or press **Esc**.

6.2 Add parts to a sequence

You can add new parts at the end of an existing sequence. If you want to add parts in the middle of the sequence, you must redefine the whole sequence.

1. On the **Manage** tab, click **Sequencer**.
2. Select a sequence name from the list.
3. Click **OK** or **Apply**.
4. Select the parts you want to add to the sequence.
5. To finish adding parts to the sequence, right-click and select **Interrupt** or press **Esc**.

6.3 Check the sequence of a part

You can check the sequence name and number of a part by using the **Inquire object** command.

1. On the ribbon, click **Inquire object** .
2. Select a part.

Tekla Structures displays the properties of the part. The sequence name and number are displayed under **More**. For example:

```
More:
Sequence 1      : 4
Sequence 2      : 10
```

6.4 Modify the sequence number of a part

You can modify the sequence number that has been assigned to a user-defined attribute (UDA) of a part.

1. Double-click a part to open the part properties in the property pane.
2. Click **More**.

The current sequence number is displayed next to the UDA to which you assigned the sequence number. For example, `Sequence 1`.

3. Modify the sequence number.
4. Click **Modify**.

6.5 Delete a sequence

1. On the **Manage** tab, click **Sequencer**.
2. Select a sequence name from the list.
3. Click **Delete** and then click **Yes**.

7 Project status visualization

Use the **Project Status Visualization** tool to review the status of model objects in a specific time frame.

For example, you can use **Project Status Visualization** to display the erection schedule for groups of parts using different colors, and to identify the parts that are scheduled to be fabricated during a specific time period.

Before you can create project status visualizations, you need to define some color and transparency settings that include object groups based on date rules.

You can also define tasks for parts and assemblies using **Task manager**. The project status visualization can then be [based on tasks \(page 161\)](#).

7.1 Create a visualization

Create visualization settings to view the project status of model objects in a specific time frame.

1. On the **Manage** tab, click **Project status** to open the **Project Status Visualization** dialog.
2. Modify the visualization settings.
 - a. In the **Object representation** list, select one of the predefined object representation settings.
 - b. Define a start and end date for the time scale slider.
 - c. Define the length of the time step.
3. Select the **Refresh view automatically** checkbox.
4. Enter a unique name in the box next to the **Save as** button.
5. Click **Save as** to save the visualization settings.
6. To view the visualization in the model, click the step buttons.

7.2 Copy visualization settings to another model

You can copy project status visualization settings to another model. The visualization settings files are located in the model's `\attributes` folder, and they have the file name extension `.4d`.

1. In the model's `\attributes` folder, select the visualization settings you want to copy.
2. Select where you want to copy the settings.
 - To make the settings available in another model, copy them to the `\attributes` folder of the destination model.
 - To make the settings available in all models, copy them to the project or firm folder, defined by the advanced option `XS_PROJECT` or `XS_FIRM`.
3. Include a copy of the object representation settings file (`.rep`) and object group files (`.PObjGrp`) in the `\attributes`, project, and firm folders to ensure that all the files will work correctly.
4. Restart Tekla Structures.

7.3 Delete visualization settings

Delete the project status visualization settings that have been created using the **Project Status Visualization** tool.

1. Delete the visualization settings file located in the model's `\attributes` folder.

Project status visualization settings have the file name extension `.4d`.
2. Restart Tekla Structures.

7.4 Project status visualization example: Visualize the erection schedule of a project

This example shows how to visualize erection schedules using the **Project Status Visualization** tool.

1. Define an erection schedule for parts using the **Planned start** user-defined attribute.
 - a. Double-click a part to open the part properties in the property pane.
 - b. Click **UDAs**.

- c. On the **Workflow** tab, modify the value of the **Planned start** user-defined attribute in the **Erection** section.

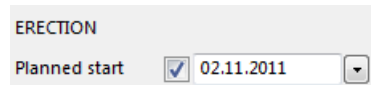

- d. Select the **Planned start** checkbox.
- e. Ensure that all other checkboxes are cleared.
- f. Select all the parts for which you want to use the same erection date.

TIP To make it easier to select parts, create a separate selection filter for each group of parts.

- g. Click **Modify**.
 - h. Repeat the steps for each group of parts in your model.
You can use a different erection date for each group of parts.
2. Select objects for the visualization by creating an object group that defines which objects are shown in the model during the visualization.
 - a. On the **View** tab, click **Representation** to open the **Object Representation** dialog.
 - b. Click **Object group...** to open the **Object group - Representation** dialog.
 - c. Create an object group that includes all objects whose **Planned start** user-defined attribute is earlier than or equal to the review date.
Define the following settings:
 - In the **Category** list, select **Object**.
 - In the **Property** list, select `PLANNED_START_E`.
 - In the **Condition** list, select **Earlier than or equal**.
 - In the **Value** list, select **Select date....**
 - In the **Select Date** dialog, select **Review date** and click **OK**.
 - d. In the box next to the **Save as** button, enter a name for the group. For example, `plan_same_or_before_review_date`.
 - e. Click **Save as**.

	(Category	Property	Condition	Value
<input checked="" type="checkbox"/>		Object	PLANNED_START_E	Earlier than or equal	Review date

3. Define the color and transparency of the selected objects using color and transparency settings that define **how** the objects are shown during the visualization.

- a. On the **View** tab, click **Representation** to open the **Object Representation** dialog.
- b. Define color and transparency settings for the object group that you created in step 2:
 - Click **Add row**.
 - In the **Object group** list, select the object group you just created.
 - In the **Color** list, select **Color by class**.
 - In the **Transparency** list, select **Visible**.
- c. Define another set of color and transparency settings to hide the rest of the parts from the model:
 - Click **Add row**.
 - In the **Object group** list, select the object group `All`.
 - In the **Color** list, select **Color by class**.
 - In the **Transparency** list, select **Hidden**.
- d. In the box next to the **Save as** button, enter a name for the settings. For example, `planned_start_erection_date`.
- e. Click **Save as**.

Object group	Color	Transparency
<code>plan_same_or_before_review_date</code>	Color by class	Visible
<code>All</code>	Color by class	Hidden

4. Define a time period for the visualization.
 - a. On the **Manage** tab, click **Project status** to open the **Project Status Visualization** dialog.
 - b. Define the length of the time step.
 - c. Define a start and end date for the time scale slider.
 - d. In the **Object representation** list, select the object representation setting you created in step 3.
 - e. Select the **Refresh view automatically** checkbox.
 - f. In the box next to the **Save as** button, enter a name for the visualization.
 - g. Click **Save as** to save the visualization settings.

Review

Review date: 02.11.2011

Step backward or forward:

<< >> 3 day(s)

Or select date on the time scale:

Scale start: 02.11.2011 Scale end: 30.11.2011

Object representation: planned_start_erection_date Edit...

Refresh view automatically

5. View the erection schedule using the **Project Status Visualization** tool.
 - a. On the **Manage** tab, click **Project status** to open the **Project Status Visualization** dialog.
 - b. In the list next to the **Load** button, select the visualization setting you created in step 4.
 - c. Click **Load**.
 - d. To view the visualization in the model, click the step buttons.

The images below show how the objects are shown when you change the review date:

Review date	Visualization
November 02	<p>The diagram shows a diamond-shaped network of nodes connected by dashed lines. The nodes are labeled as follows: A 1 (top-left), B 1 (top), 2 (top-right), 3 (middle-top), 4 (middle), 5 (middle-bottom), 6 (bottom), 7 (bottom-left), and B (bottom-right). A red arrow points to node A 1.</p>

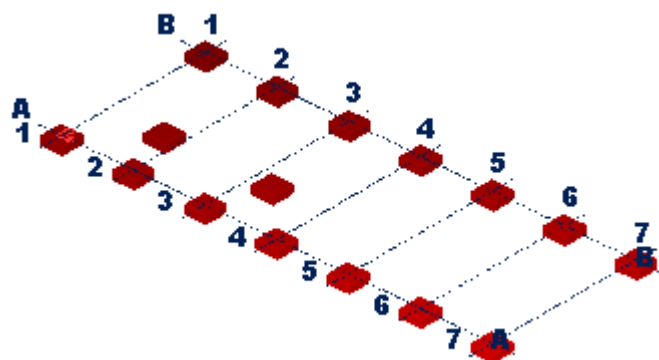
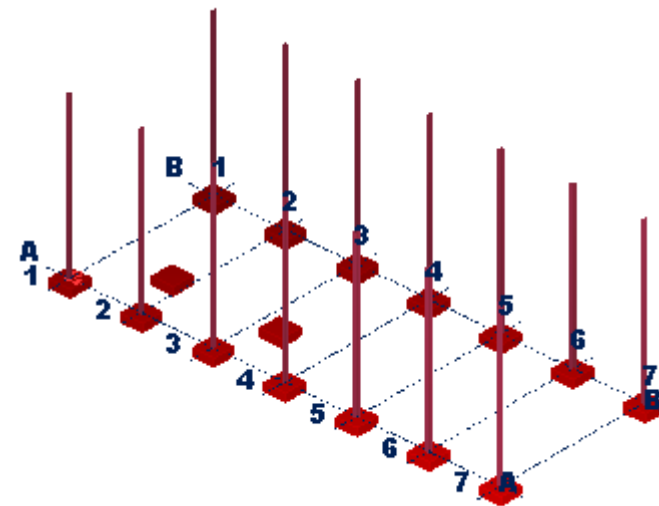
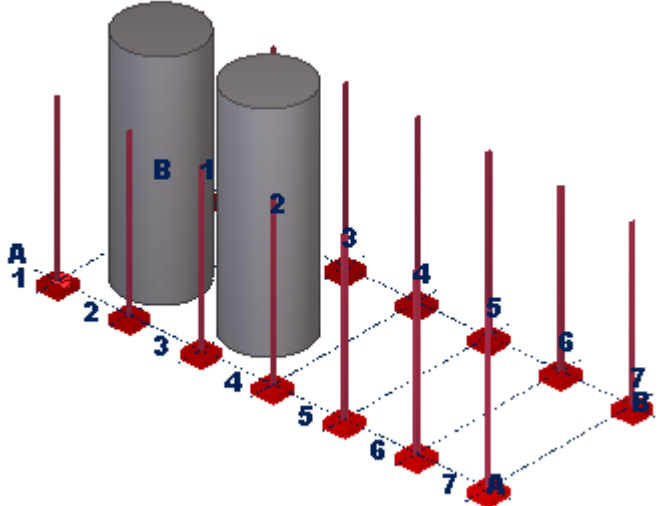
Review date	Visualization
November 05	
November 08	
November 11	

Review date	Visualization
November 14	<p>A 3D visualization of a project structure. It features two grey cylinders, labeled 'B 1' and 'B 2', positioned on a grid of red supports. The grid is labeled with 'A' and 'B' on the vertical axis and '1' through '7' on the horizontal axis. Purple beams connect the supports, forming a network of paths. The cylinders are positioned at grid points (B, 1) and (B, 2).</p>
November 17	<p>A 3D visualization of the same project structure as above, but with a grey rectangular platform added on top of the grid. The platform is labeled with '3' through '6' on its horizontal axis. The cylinders are still positioned at grid points (B, 1) and (B, 2).</p>

8 Reports

You can create reports of the information included in Tekla Structures models. Reports can be lists of drawings, bolts, and parts, for example. Tekla Structures creates reports directly from the model database, so the information is always accurate. Reports can contain information about selected parts or the entire model.

Tekla Structures includes a large number of standard report templates. Use Template Editor to modify the existing report templates, or create new ones to suit your needs.

Note that the reports do not get updated automatically when the model changes, you need to recreate the reports.

The report templates are by default located in the system folders defined for the advanced option `XS_SYSTEM`. Report templates have the file name extension `.rpt`.

Example

TEKLA STRUCTURES PARTS LIST FOR CONTRACT NO: 1					Page: 1	
CONTRACT: Tekla Corporation					Date: 16.09.2009	
PartPos	Profile	No.	Material	Length	Area (m2)	Weight (kg)
Concrete	250*12000	2	K30-2	12000	227.6	0.0
Concrete	250*12000	6	K30-2	12000	250.2	0.0
Concrete	250*14997	18	K30-2	12000	278.4	0.0
Concrete	250*14997	54	K30-2	12000	301.0	0.0
Concrete	1500*1500	8	K30-2	500	7.5	0.0
Concrete	500*1000	4	K30-2	12000	37.0	0.0
Concrete	380*380	80	K40-1	4000	6.4	0.0
Concrete	4000*300	80	K30-2	12000	105.6	0.0
Concrete	CHS323.9X7.1	80	S275J0	4000	4.1	222.0
Concrete	800*400	80	Concret	8620	21.3	6620.2
P/1	IPE500	80	S235JR	12000	20.9	1092.7
P/2	IPE500	80	S235JR	13909	24.3	1266.6
Total for 572 members:					38030.7	736117.6

For more information about using Template Editor, see Template Editor Help. To open the help, open Template Editor and click **Help** --> **Contents** . Here you can find a link to the Template Editor User's Guide in the PDF format: Tekla Structures [Tekla Structures PDF documentation](#).

See also

[Create a report \(page 182\)](#)

[Prepare and create an Excel \(XLSX\) report \(page 186\)](#)

[Show an existing report \(page 196\)](#)

[Print a report \(page 197\)](#)

[Tips for reports and report templates \(page 200\)](#)

8.1 Create a report

You can include in a report information related to an entire model or only the selected model objects. Tekla Structures automatically selects the related assemblies and other objects. You can also create a report of several drawings that include the desired model objects. Furthermore, you can produce a list of assemblies, or a report of the parts included in the assemblies. If the report template has a nested assembly structure, Tekla Structures displays the assembly hierarchy in the report when you view or print it.

You can create reports in several formats, such as `.xsr`, `.html`, `.csv`, and PDF. You can have Tekla Structures open all `.html` reports in a web browser. By

default, all reports are displayed in a new dialog within the Tekla Structures window.

Create a report of entire model or selected objects

1. Open the model.
2. If needed, number the model.

You can create reports without numbering the model. This is useful when you need to produce draft reports from large multi-user models. Tekla Structures still warns you if numbering is not up to date.
3. On the **Drawings & reports** tab, click **Reports**.
4. Define the viewing settings on the **Options** tab, or load the settings that contain the desired viewing settings. You can select whether to view the report in a dialog or in an associated viewer, and also whether to show the report after creation or not.

We recommend that you set the viewing options to the ones that you use the most often and save the settings in the standard settings file by clicking the **Save** button at the top. You can also save the settings to another file by using **Save as**.
5. Select a report template from the **Report templates** list. When you select a template, you can see the name of the template and the template format in the **Report file** box.
6. Under **Titles in reports**, enter the desired report titles.
7. In the **Name** box, you can change the report file name and browse to the folder where you want to save the report. By default, reports are saved in the `\Reports` folder under the model folder.
8. Unless you want to create a report of the entire model, select the objects you want to include in the report using appropriate selection switches and filters.
9. Do one of the following:
 - To run a report on the entire model, click **Create from all**.
 - To run a report on the selected model objects, click **Create from selected**.

Tekla Structures creates the report according the settings you defined, and shows the report if you have selected to show it. By default, the report is saved in the `\Reports` folder under the model folder.

Create a report of selected drawings

1. Create drawings of the model objects you want to include in the report.
2. Open the model.
3. On the **Drawings & reports** tab, click **Document manager**.
4. In **Document manager**, select the drawings you want to include in the report.

TIP To select multiple drawings, hold down **Ctrl** and then click the drawings you want to select.

5. On the **Drawings & reports** tab, click **Reports**.
6. Select a drawing report template from the list.
For example, select **Drawing_List** or **Drawing_Revision_History**.
7. Under **Titles in reports**, enter the desired report titles.
8. In the **Name** box, you can change the report file name and browse to the folder where you want to save the report. By default, reports are saved in the `\Reports` folder under the model folder.
9. Go to the **Options** tab and set the viewing options. You can select whether to view the report in a dialog or in a viewer, and also whether to show the report immediately after creation or not.
10. Click **Create from selected**.
Tekla Structures selects the drawings and includes their information in the report, creates the report according the settings you defined, and shows the report if you have selected to show it.

Create a report of nested assemblies

1. Open the model.
2. Select the assemblies you want to include in the report.
3. On the **Drawings & reports** tab, click **Reports**.
4. Select an assembly report template from the list.
The following reports can be found in the default environment.
 - **Assembly_List**: Creates a list of the assemblies
 - **Assembly_Part_List**: Creates a report of the parts included in the assemblies
5. Under **Titles in reports**, enter the desired report titles.

6. In the **Name** box, you can change the report file name and browse to the folder where you want to save the report. By default, reports are saved in the `\Reports` folder under the model folder.
7. Go to the **Options** tab and set the viewing options. You can select whether to view the report in a dialog or in an associated viewer, and also whether to show the report or not.
8. Click **Create from selected**.

Tekla Structures creates the report according the settings you defined and shows the report if you have selected to show it.

Report settings

Setting	Description
Report templates	Lists all the available report templates.
Titles in reports	Optional report titles. You can enter up to three report titles. All titles are not used in every standard report. Title1 , for example, is used to show phase information in the Assembly_list report.
Browse	Use to change the folder where the report will be stored. By default, reports are stored in the <code>\Reports</code> folder under the current model folder.
Show	Shows the selected report.
Print	Prints the selected report.
Create from all	Creates a report from all objects in the model using the selected template.
Create from selected	Creates a report from the objects you have selected using the selected template.
Options: Show report	Defines how Tekla Structures displays reports. On dialog displays the report in a new window. With associated viewer displays the report in the associated program. For example, you can have Tekla

Setting	Description
	Structures open all HTML reports in a web browser.
Options: Show created report	Defines whether or not the report is automatically shown on the screen after it has been created.

8.2 Prepare and create Excel (XLSX) reports

You can create Excel (.xlsx) reports in Tekla Structures. The content and formatting of these reports is defined using an `.xlsx.rpt` template created with Template Editor and an `.xltx` template created with Microsoft Excel.

Compared to the older HTML-based templates or Organizer, the Excel (.xlsx) reporting method:

- **Eliminates VBA macros:** You no longer need to create and maintain complex, brittle VBA macros, which are difficult to edit and are increasingly restricted by corporate IT security policies.
- **Provides full formatting control:** Unlike the limited HTML-based report (`.xls.rpt`), this method allows for fully pre-configured Excel templates (`.xltx`). You can define company logos, headers/footers, print settings, cell formats, and advanced table styles. The final report is a native, ready-to-use Excel file.
- **Improves security and compatibility:** The resulting modern `.xlsx` format is the industry standard and avoids security filters that often block or quarantine older macro-enabled `.xls` files.
- **Streamlines workflow:** The process is more direct and intuitive, reducing the steps to get a polished, finalized report from Tekla Structures.

Notes and limitations

- For complex formatting, like using Excel built-in table styles for alternating row colors, we highly recommend you to define it within the `.xltx` Excel template, rather than relying on the basic formatting options in the `.rpt` file.
- Report logic, such as `if` statements, is handled within the Template Editor value field formulas, not within the export process itself.
- To use `{ }` as literal characters in the Excel template, avoid using them for non-attribute text. The curly brackets `{ }` are reserved for Tekla Structures attributes, but a cell can contain multiple attributes and other text (for example, "Part: {PART_POS}, Weight: {WEIGHT}").

Steps to produce an XLSX report

1. In Microsoft Excel, prepare the Excel template (`.xltx`).

2. In Template Editor, prepare the textual template (.xlsx.rpt).
3. In Tekla Structures, export the Excel report (.xlsx).

For details, see the instructions below.

Prepare Excel template (.xltx)

1. In Microsoft Excel, design your report template.
Define the desired layout, including company logos, static text, cell formatting, formulas, and print settings.
2. In header cells, insert project attribute placeholders to tell Tekla Structures where to insert data, like {PROJECT.USERDEFINED.P_PROJ_INFO_1}.
 - **Project/report attributes:** Place Tekla Structures attributes inside curly brackets (for example, {PROJECT.NUMBER}, {PROJECT.NAME}) in any cell. These will be populated with the corresponding project information upon export.
 - **Main data insertion point:**
 - By default, data is added to the first empty row in the Excel template. The last row in the Excel template that has content is treated as the header row. The first empty row here means the first empty row that does not have any data after it (no cells containing data).
 - Optionally, a special text string, "%&O%&", can be placed in a cell to mark where the main data rows from the .rpt file will be inserted. The string can optionally include the header row number, for example, "%&O5%&". The row containing this string is cleared, and the data is inserted starting from the next row. If the header row is not specified, the last row before the insertion point that has content is treated as the header row for column matching. See an example in the "Examples" section below.
 - Define column headers for your data table. The data will typically be inserted after the defined header row in the first available empty row, making the special string "%&O%&" optional. However, if the data should be inserted somewhere other than the first empty row, or if a different row than the one just above the insertion point should be used as the header row, then you must manually type the special string "%&O%&" in the desired cell.
3. Save the file as an Excel template (.xltx) in one of the company standard Tekla Structures folders (model, project, firm, or system).

Prepare textual template (.xlsx.rpt)

1. In Template Editor, create a new textual template, or modify an existing one.
2. The header section in the template is ignored during the Excel export but can be used for instructions. The last line of the header can contain the column headers for the data rows. The column headers can be used to match columns with the .xltx template.

The header is optional, but is required if column mapping (export setting **Match columns between report template and Excel template**) is to be used. If the columns are in the same order in both files, mapping is not necessary.

3. Add the required value fields to the `row` component.
A text object containing a semicolon (;) must be placed between the value fields to act as a column separator.
4. Save the report with the .xlsx.rpt extension in one of the company standard Tekla Structures folders (model, project, firm, or system).

Export Excel report

1. Open the model.
2. If needed, number the model.
3. On the **Drawings & reports** tab, click **Reports**.
4. In the **Report** dialog, select a report template with the .xlsx suffix.

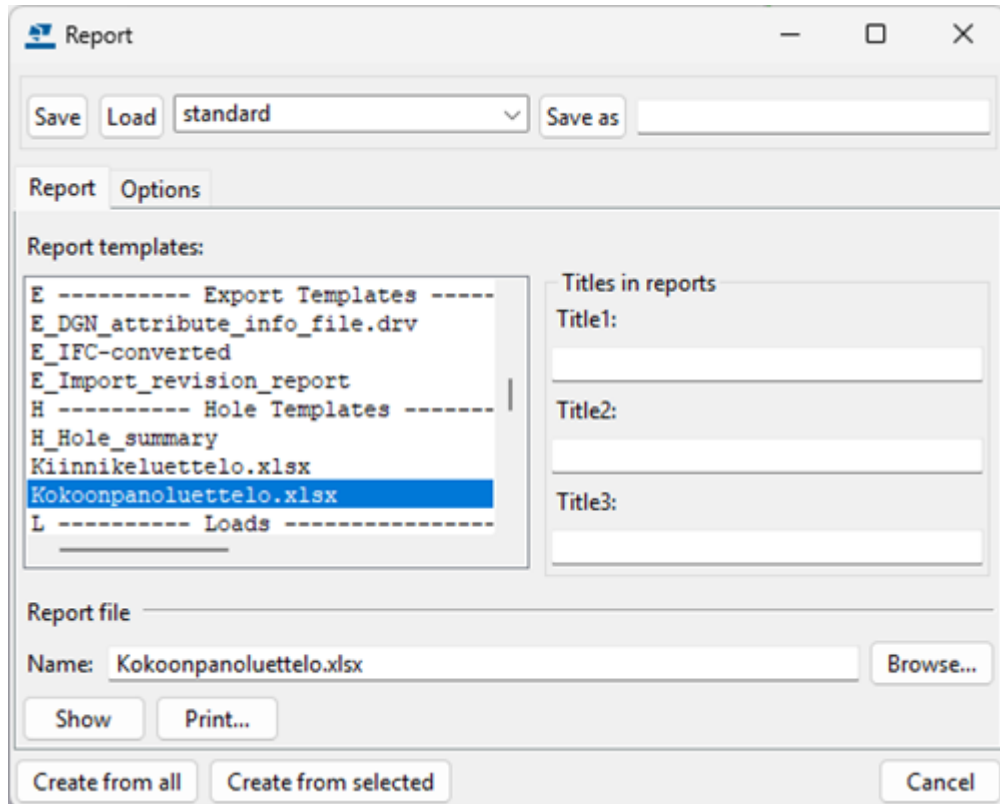

5. Do one of the following:
 - To run a report on the entire model, click **Create from all**.
 - To run a report on the selected model objects, click **Create from selected**.
6. In the displayed **Export data to Excel** dialog, select the Excel template (.xlsx) to use and define the export settings.

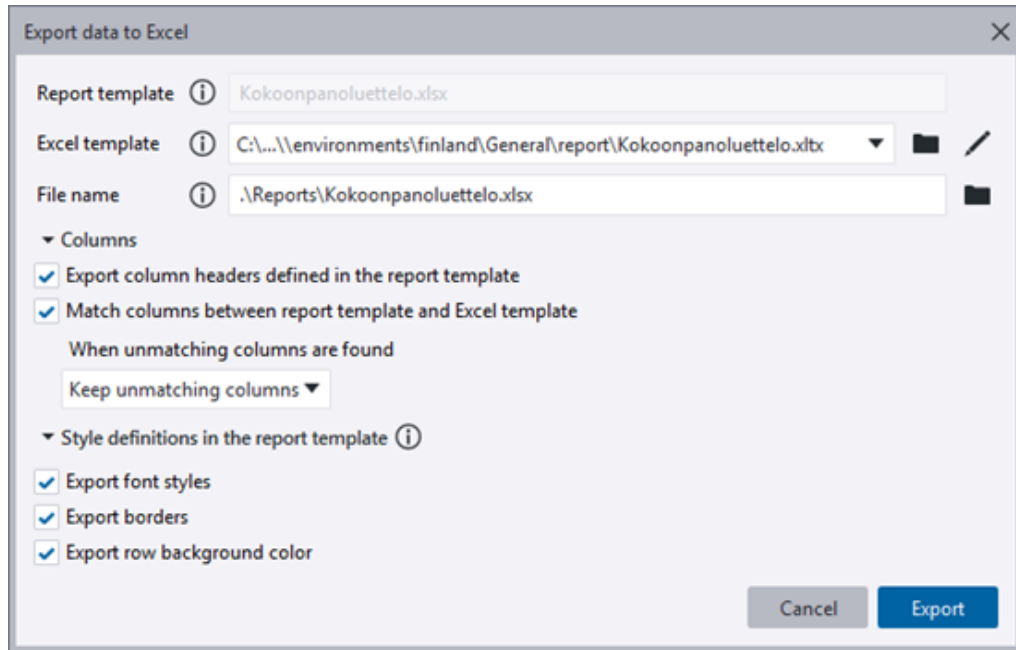

The available options:



- **Excel template:** Select the target `.xlsx` template from the dropdown list. The list shows **Export to an empty sheet**, up to 10 recently used templates, and all available templates from the standard folders.
- Configure the export using the checkboxes. These settings are preserved for the current Tekla Structures session.
 - **Export column headers defined in the report template:** Exports the column headers from the `.xlsx.rpt` file as the first row of the data block.
 - **Match columns between report template and Excel template:** Maps the columns from the `.rpt` file to the columns in the `.xlsx` file by matching the header names. If this is not selected, columns are inserted in the order they appear in the `.rpt` file.
 - **When unmatching columns are found:** Select one of the following options which are available only if **Match columns between report template and Excel template** is selected:
 - Discard unmatching columns:** Columns from the `.rpt` file that do not have a matching header in the `.xlsx` template will not be included in the export.
 - Keep unmatching columns:** The unmatching columns will be exported and placed to the right of the columns defined in the `.xlsx` template.
 - **Export font styles:** Exports the bold and italic styles set in the `.rpt` file.

Assembly ID	Main part ID	Assembly	Main part name	Main part profile	Number	Length [mm]	Length [cm]	Weight [kg]	Weight [lb]	Area [m2]	Area [sq ft]	Drawing	Date	Release date	Colorset	Color lines	Paint thickness	Section	Floor
6	ASSEMBLY MAIN PART POS	MAIN PART NAME	MAIN PART PROFI	NUMBEF LENGTH [mm]	LENGTH [cm]	SL WEIGHT[kg]	WEIGHT	SU AREA [m2]	AREA [sq ft]	DR_NAME	DR_DATE	REV	REV_DATE	COLOR	TOI	PAINT_THICK	Section	Floor	
7	16392040	16392035	A/22	SUPPORT	D50	12	3394	40729	0	0	4.98	59.76						A	1
8	16373440	16373435	A/22	SUPPORT	D50	12	3394	40729	0	0	0	0						A	2
9	16355282	16355277	A/22	SUPPORT	D50	12	3394	40729	0	0	0	0						A	3
10	16337061	16337056	A/22	SUPPORT	D50	16	3394	54496	0	0	0	0						A	4
11	16311014	16311009	A/22	SUPPORT	D50	12	3394	40729	0	0	0	0						B	1
12	16282937	16282932	A/22	SUPPORT	D50	12	3394	40729	0	0	0	0						B	2
13	16265025	16265020	A/22	SUPPORT	D50	12	3394	40729	0	0	0	0						B	3
14	16246887	16246882	A/22	SUPPORT	D50	12	3394	40729	0	0	0	0						B	4
15	16319068	16319063	A/22	SUPPORT	D50	12	3394	40729	0	0	0	0						B	BASEMENT
16	16664507	16662096	AB/3001	ANCHOR ROD	D20	8	250	2000	53.4	427.4	1.58	12.65						A	BASEMENT
17	15605855	15601782	AB/3001	ANCHOR ROD	D20	6	250	1500	0	0	0	0						A	BASEMENT

8.3 Create multiple reports using Multireport generator

The **Multireport generator** application allows you to generate multiple reports in one go from all or selected model objects. Additionally, you can automatically open reports in the desired format.

Create multiple reports

1. Select the objects you want to include in the reports using appropriate selection switches and filters, unless you want to create a report from the entire model.
2. Click the **Applications & components** button  in the side pane to open the **Applications & components** catalog.
3. In the catalog, click the arrow next to **Applications** to open the applications list.
4. Double-click the  **Multireport generator** application icon. The **Multireport generator** dialog is displayed.

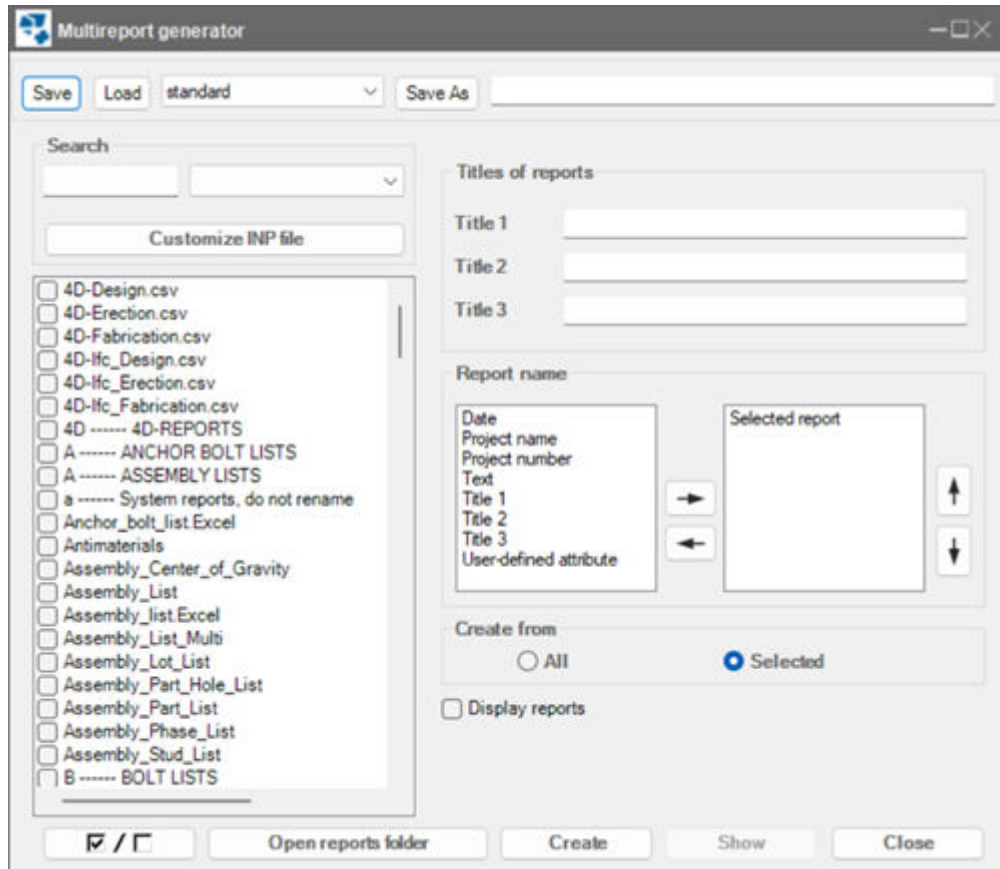

By default, the template list contains the templates located in the following locations:

- current model folder
- XS_PROJECT
- XS_FIRM
- XS_TEMPLATE_DIRECTORY
- XS_TEMPLATE_DIRECTORY_SYSTEM
- XS_SYSTEM
- To adjust which folders are used, right-click the template list and select **Folder choice**.
- To modify a template, right-click the template in the list and select **Open in TplEd**.
- You can also [download Template Editor Excel templates](#) and matching Excel templates from Tekla Warehouse to use in **Multireport generator**. Copy these templates into one of the folders mentioned above.

5. Search for the desired report templates.

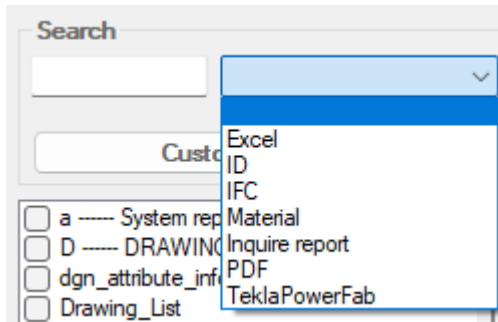

- To search by template name, start typing template name in the **Search** box.

The templates matching the text you entered are displayed in the template list.

- To filter the template list using predefined filters, select a filter from the list next to the **Search** box. The template list now shows only the templates that match the filter you selected.

You can modify the filter list, see "Modify template search filters" below.

6. Select the desired templates.

- To create multiple reports using different templates, select all the desired report templates from the list.
- To create a report and open it in another format, for example, as Microsoft Excel or PDF, select a Template Editor template and a matching Excel or PDF template.

7. In **Report name**, select the elements to use in the report file name.

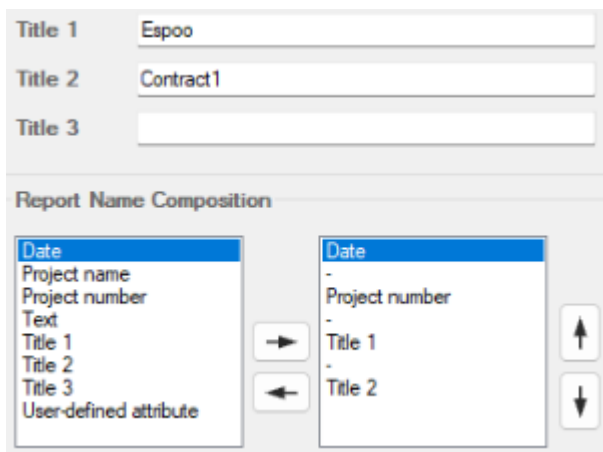

- By default, the report name contains the name of the selected report template.

- To add a name element in the report name, double-click the desired element in the list on the left. You can also select the element and click the right arrow button.

- To change the order of the elements in the name, use the up and down arrow buttons on the right.

Example: The report name is 30.1.2026-1234-Espoo-Contract1.xsr. To get this name, the **Title 1** and **Title 2** options were defined, and the following elements were selected: **Date**, **Text (-)**, **Project number**, **Text (-)**, **Title 1**, **Text (-)**, and **Title 2**.

8. In **Create from**, select one of the following options:
 - **All**: Create reports from all model objects.
 - **Selected**: Create reports from the model objects you selected.
9. To open the reports after the creation, select the **Display reports** checkbox.
10. To create the reports, click **Create**.

By default, the reports are created in the `\Reports` folder under the current model folder. You can open the folder where the reports are created by clicking the **Open reports folder** button, or show the created reports by clicking the **Show** button.

If you selected a Template Editor template and a matching template in another format, the report is created in that other format.

Modify template search filters

1. To open the search filter list, click the **Customize INP file** button.
2. In the displayed dialog, you can add, modify, or remove filters.

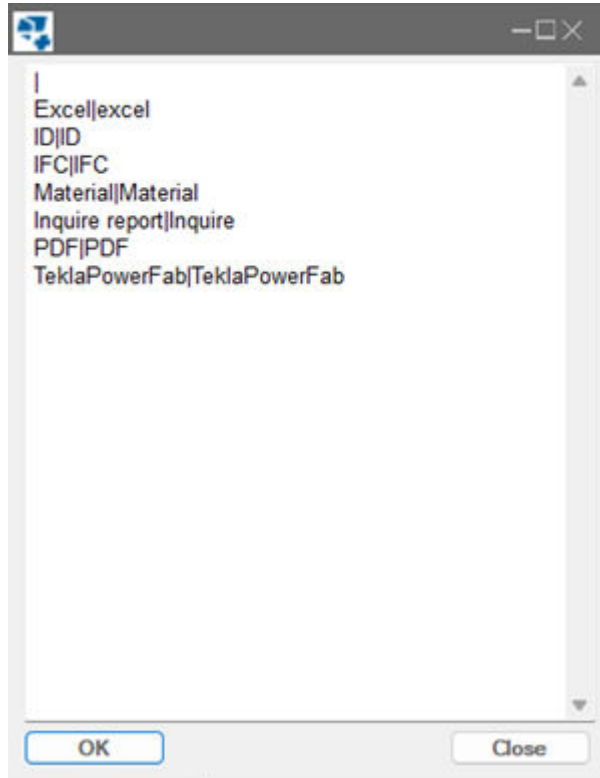

- Do not remove the first line including the separator character |, because removing the line will make the INP file invalid. You can copy the first line when you are creating new filters.
 - To add a filter, add a new line and type the name of the filter that will be displayed in the filter list. Then add the separator character | and then the search string. The search string can be a whole word or part of a word. You can use multiple search strings separated by a space. The search strings are case sensitive.
 - To remove a filter, select the row and press **Delete** on the keyboard.
3. Click **OK** to save the search filters and close the dialog.

8.4 Show an existing report

You can show in a separate window reports that you have created of the current model.

1. On the **Drawings & reports** tab, click **Reports**.
2. Define the viewing settings on the **Options** tab, or load the settings that contain the desired viewing settings. You can select whether to view the

report in a dialog or in an associated viewer, and also whether to show the report after creation or not.

We recommend that you set the viewing options to the ones that you use the most often and save the settings in the standard settings file by clicking the **Save** button at the top. You can also save the settings to another file by using **Save as**.

3. Click **Browse** to locate the report file you want to view, select the file and click **OK**.
4. Click **Show** to view the report the dialog or in an associated viewer according to your selection.

When you click an object ID row, the corresponding object is highlighted in the model.

Useful shortcuts for viewing reports

To	Do this
Zoom to the objects selected in a report	<ol style="list-style-type: none"> 1. Hold down Z. 2. Click a row that contains an ID number. <p>Tekla Structures zooms to the corresponding objects in the active model view.</p>
Fit the work area to include only the objects selected in a report	<ol style="list-style-type: none"> 1. Hold down F. 2. Click a row that contains an ID number. <p>Tekla Structures zooms to the corresponding objects in the active model view.</p>

See also

[Create a report \(page 182\)](#)

8.5 Print a report

You can print a report from the **Reports** dialog box or through the **File** menu.

1. Do one of the following:
 - On the **Drawings & reports** tab, click **Report**, and then click **Print**.
 - On the **File** menu, click **Printing** --> **Print reports**.

2. Use the **Browse** button to display the **Select file** dialog , where you can browse to the desired folder and select the report.

By default, Tekla Structures uses the **Report files (*.xsr)** filter to show Tekla Structures *.xsr reports only. To show all file types, change the filter to **All files (*.*)**.

3. If needed, modify the printing settings:
 - To change the report font and font style, click **Select**.
In the displayed dialog, you can only change the font and font style, the font size is fixed to 12. One way to change the font size is to open the created report in a text editor and change the font size there.
The default font is Arial, and the default font can be changed with the advanced option XS_PRINT_REPORT_FONT.
 - To set printer-specific options such as paper size and orientation, click **Printer setup**.
4. Click **Print**. The report is printed.

Embed fonts in PDF reports

The PDF report options are read from a settings file `report.PdfPrintOptions.xml`. This allows the embed fonts option to be enabled for languages that require it. This file is not included by default in environments, but some environments might include it. If no such file is present, the default hard coded options are used.

The settings file can be present in any location where `PdfPrintOptions.xml` files are normally searched for. For more information about printing settings and file locations, see [Printing settings files and search order](#).

To embed fonts, open the `report.PdfPrintOptions.xml` file in a text editor, for example Microsoft Notepad, and change `<EmbedFonts>>false</EmbedFonts>` to `<EmbedFonts>>true</EmbedFonts>`. Save the file in the environment folder where you found it, or in the current model folder, or in any of the folders defined by the XS_SYSTEM advanced option, for example.

```
<?xml version="1.0" encoding="utf-8"?>
<PdfPrintOptions Version="1.4">
  <Options>
    <PrintTarget>PDF</PrintTarget>
    <PrinterName>PDF-XChange 3.0</PrinterName>
    <PDFAndPlotFileLocation>.\Plotfiles</PDFAndPlotFileLocation>
    <EmbedFonts>>true</EmbedFonts>
    <OpenFolderWhenFinished>>false</OpenFolderWhenFinished>
    <OpenFileWhenFinished>>false</OpenFileWhenFinished>
    <OutputToSingleFile>>false</OutputToSingleFile>
    <SinglePDFFileName>Combined</SinglePDFFileName>
    <PlotFileExtension>plt</PlotFileExtension>
    <PlotFilePrefix />
    <PlotFileSuffix />
    <ScalingMethod>Auto</ScalingMethod>
    <ScaleFactor>1</ScaleFactor>
    <CenterDrawingOnPaper>>false</CenterDrawingOnPaper>
    <PrintOnMultipleSheets>>false</PrintOnMultipleSheets>
    <MultipleSheetOrder>LeftToRightTopToBottom</MultipleSheetOrder>
```

```

<PaperSize>Auto</PaperSize>
<Orientation>Auto</Orientation>
<ColorMode>Color</ColorMode>
<NumberOfCopies>1</NumberOfCopies>
<Collate>false</Collate>
<IncludeRevision>false</IncludeRevision>
<DefaultLineProperties PlotColor="0xFF000000" Pen="15"
OutputMode="Object" />
<LineThicknesses>
  <LineThickness Color="151" Pen="0" />
  <LineThickness Color="150" Pen="0" />
  <LineThickness Color="0" Pen="0" />
  <LineThickness Color="152" Pen="10" />
  <LineThickness Color="153" Pen="10" />
  <LineThickness Color="160" Pen="18" />
  <LineThickness Color="161" Pen="25" />
  <LineThickness Color="162" Pen="50" />
  <LineThickness Color="163" Pen="70" />
  <LineThickness Color="164" Pen="35" />
  <LineThickness Color="165" Pen="13" />
  <LineThickness Color="154" Pen="15" />
  <LineThickness Color="155" Pen="15" />
  <LineThickness Color="156" Pen="15" />
  <LineThickness Color="157" Pen="15" />
  <LineThickness Color="158" Pen="15" />
  <LineThickness Color="159" Pen="15" />
  <LineThickness Color="130" Pen="15" />
  <LineThickness Color="131" Pen="15" />
  <LineThickness Color="132" Pen="15" />
  <LineThickness Color="133" Pen="15" />
  <LineThickness Color="0xFF004F83" Pen="15" />
  <LineThickness Color="0xFF0063A3" Pen="15" />
  <LineThickness Color="0xFFFFBAD26" Pen="35" />
  <LineThickness Color="0xFF252A2E" Pen="15" />
  <LineThickness Color="0xFF0E416C" Pen="15" />
  <LineThickness Color="0xFF217CBB" Pen="15" />
  <LineThickness Color="0xFFDCEDF9" Pen="15" />
  <LineThickness Color="0xFF353A40" Pen="15" />
  <LineThickness Color="0xFFD88228" Pen="15" />
</LineThicknesses>
<PlotColors>
  <PlotColor Color="151" PlotColor="0xFF000000" />
  <PlotColor Color="150" PlotColor="0xFFFFFFFF" />
  <PlotColor Color="0" PlotColor="0xFF000000" />
  <PlotColor Color="152" PlotColor="0xFFE7E7E7" />
  <PlotColor Color="153" PlotColor="0xFF000000" />
  <PlotColor Color="160" PlotColor="0xFFFF0000" />
  <PlotColor Color="161" PlotColor="0xFF54EC54" />
  <PlotColor Color="162" PlotColor="0xFF0000FF" />
  <PlotColor Color="163" PlotColor="0xFF00BBE0" />
  <PlotColor Color="164" PlotColor="0xFF7F7F00" />
  <PlotColor Color="165" PlotColor="0xFFC400CD" />
  <PlotColor Color="154" PlotColor="0xFF804040" />
  <PlotColor Color="155" PlotColor="0xFF00A000" />
  <PlotColor Color="156" PlotColor="0xFF333399" />
  <PlotColor Color="157" PlotColor="0xFF008080" />
  <PlotColor Color="158" PlotColor="0xFFFF9933" />
  <PlotColor Color="159" PlotColor="0xFF706B70" />
  <PlotColor Color="130" PlotColor="0xFF4C4C4C" />
  <PlotColor Color="131" PlotColor="0xFF7F7F7F" />
  <PlotColor Color="132" PlotColor="0xFFB2B2B2" />
  <PlotColor Color="133" PlotColor="0xFFE5E5E5" />
  <PlotColor Color="0xFF004F83" PlotColor="0xFF004F83" />
  <PlotColor Color="0xFF0063A3" PlotColor="0xFF0063A3" />
  <PlotColor Color="0xFFFFBAD26" PlotColor="0xFFFFBAD26" />
  <PlotColor Color="0xFF252A2E" PlotColor="0xFF252A2E" />
  <PlotColor Color="0xFF0E416C" PlotColor="0xFF0E416C" />

```

```

    <PlotColor Color="0xFF217CBB" PlotColor="0xFF217CBB" />
    <PlotColor Color="0xFFDCEDF9" PlotColor="0xFFDCEDF9" />
    <PlotColor Color="0xFF353A40" PlotColor="0xFF353A40" />
    <PlotColor Color="0xFFD88228" PlotColor="0xFFD88228" />
</PlotColors>
<OutputModes>
  <OutputMode Color="151" OutputMode="Custom" />
  <OutputMode Color="150" OutputMode="Custom" />
  <OutputMode Color="0" OutputMode="Custom" />
  <OutputMode Color="152" OutputMode="Custom" />
  <OutputMode Color="153" OutputMode="Custom" />
  <OutputMode Color="160" OutputMode="Custom" />
  <OutputMode Color="161" OutputMode="Custom" />
  <OutputMode Color="162" OutputMode="Custom" />
  <OutputMode Color="163" OutputMode="Custom" />
  <OutputMode Color="164" OutputMode="Custom" />
  <OutputMode Color="165" OutputMode="Custom" />
  <OutputMode Color="154" OutputMode="Custom" />
  <OutputMode Color="155" OutputMode="Custom" />
  <OutputMode Color="156" OutputMode="Custom" />
  <OutputMode Color="157" OutputMode="Custom" />
  <OutputMode Color="158" OutputMode="Custom" />
  <OutputMode Color="159" OutputMode="Custom" />
  <OutputMode Color="130" OutputMode="Custom" />
  <OutputMode Color="131" OutputMode="Custom" />
  <OutputMode Color="132" OutputMode="Custom" />
  <OutputMode Color="133" OutputMode="Custom" />
  <OutputMode Color="0xFF004F83" OutputMode="Custom" />
  <OutputMode Color="0xFF0063A3" OutputMode="Custom" />
  <OutputMode Color="0xFFFFBAD26" OutputMode="Custom" />
  <OutputMode Color="0xFF252A2E" OutputMode="Custom" />
  <OutputMode Color="0xFF0E416C" OutputMode="Custom" />
  <OutputMode Color="0xFF217CBB" OutputMode="Custom" />
  <OutputMode Color="0xFFDCEDF9" OutputMode="Custom" />
  <OutputMode Color="0xFF353A40" OutputMode="Custom" />
  <OutputMode Color="0xFFD88228" OutputMode="Custom" />
</OutputModes>
</Options>
<PreviewMinimumPenWidth>0.5</PreviewMinimumPenWidth>
</PdfPrintOptions>

```

8.6 Tips for reports and report templates

There are some things that you might consider to be able to create reports more efficiently.

Select objects to include in a report using GUIDs

You can select objects to be included in reports by using their GUIDs (globally unique identifiers).

1. In Template Editor, create a template that is used for creating the report:
 - a. In Tekla Structures, on the **File** menu, click **Editors --> Template Editor** .
 - b. In Template Editor, click **File --> New** .

- c. Select **Textual template** and click **OK**.
 - d. Add a row for the GUID.
 - Click **Insert --> Component --> Row** .
Select a content type for the row and clicking **OK**.
 - Click **Insert --> Text** and enter the text `guid:`, `Guid:` or `GUID:`.
Click **OK**.
This enables the selecting of objects in the model.
 - Click **Insert --> Value Field** . Click a point to define the location of the field within the row. The **Select Attribute** dialog box appears prompting you to select an attribute for the value field.
Select the attribute **GUID** and click **OK**.
 - e. Add the required amount of other rows in the template.
 - f. Click **File --> Save As** .
Enter a name for the template and browse to the folder that has been defined templates for the advanced option `XS_TEMPLATE_DIRECTORY`. Use the file name extension `.rpt`.
2. Create a report based on the report template you saved.
 - a. On the **Drawings & reports** tab, click **Reports**.
 - b. Select the report template you created from the list.
 - c. Click **Create from all**.
Tekla Structures displays the report.
 3. Click a row that contains an GUID number in the report.
Tekla Structures selects the corresponding object in the active model view.

Show report content in correct cells

You can associate Tekla Structures to open reports of a certain type in Microsoft Excel. When you open such reports in Microsoft Excel, the report template rows might not be divided correctly into cells. To correct this, you can add tabs between the cells.

1. Open an existing report template in Template Editor.
2. Add `\t` between the text and value fields. For example:

```

Tekla Structures MATERIAL LIST
Project number:      \t Project_number
Project name:       \t Project_info_1
Project address:    \t Project_info_2
                   \t Project_info_3
                   \t Project_info_4
Date:               \t Report_creation_date
Profile      \t Material \t NUM \t Length [mm] \t Length sum
Profile      \t Mater  \t NUM \t Length      \t Length_su

```

3. Save the report.

The output in Microsoft Excel:

	A	B	C	D	E	F	G	H
1	Tekla Structures MATERIAL LIST							
2								
3	Project number:							
4	Project name:							
5	Project address:							
6								
7								
8	Date:	07.12.2009						
9								
10	Profile	Material	NUM	Length [mm]	Length sum	Weight[kg]	Weight sum	Area [m2]
11	175*600	K40-1	2	6050	12100	0.0	0.0	9.59
12	175*9000	K40-1	2	9000	18000	0.0	0.0	168.30
13	1800*1800	K40-1	7	650	4550	0.0	0.0	11.16
14	2700*2700	K40-1	17	850	14450	0.0	0.0	23.76
15	D6400	S355JR	2	18000	36000	4543782.8	9087565.7	426.19
16	D7000	K40-1	2	800	1600	0.0	0.0	94.53
17	HEA300	S355JR	72	13400	964800	1183.4	85203.9	23.01

The output in a text editor:

```

Material_list.Excel - Notepad
File Edit Format View Help
Tekla Structures MATERIAL LIST

Project number:
Project name:
Project address:

Date:                07.12.2009

Profile      Material      NUM      Length [mm]      Length sum      weight[kg]
175*600      K40-1                2         6050              12100           0.0
175*9000     K40-1                2         9000              18000           0.0
1800*1800    K40-1                7         650               4550            0.0
2700*2700    K40-1               17         850              14450           0.0
D6400        S355JR               2        18000            36000          4543782.8
D7000        K40-1                2         800               1600            0.0
HEA300       S355JR              72        13400            964800         1183.4
IPE600       S355JR               1         4150              4150            508.2
IPE600       S355JR               8         5657              45255           692.7
IPE600       S355JR               4         6000              24000           734.8
IPE600       S355JR               2         9000              18000           1102.1
IPE600       S355JR              26        13150            341900         1610.3
P18(175x12   K40-1               219        6159            1348801         0.0
RHS150*150   S355JR               3         8415              25245           190.9
RHS150*150   S355JR               3         8846              26538           200.7

```

TIP Alternatively, you can use a comma or semicolon as a delimiter between the text fields. However, the default delimiter may vary between users, and the output might not be readable in all text editors.

Add cell separator in Excel reports

You Tekla Structures installation contains reports that can be opened in Microsoft Excel. These reports have the file extension *.csv.rpt.

If you have your own Excel reports in Tekla Structures with the file extension *.csv.rpt, you can add the text **sep=;** on the page header row in the report templates. This forces Microsoft Excel to open the file using the ; character as the cell separator, and ensures the correct separation of the cells in Microsoft Excel. The ";" character is automatically recognized as the separator, regardless of the language you are using.

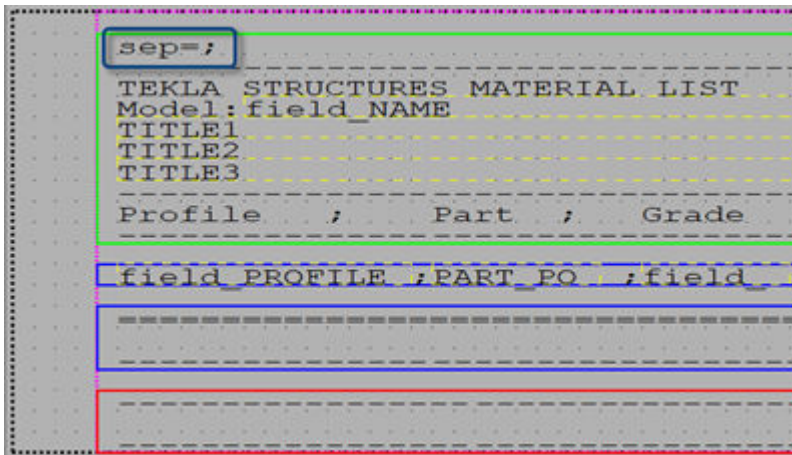

The image shows a text-based report template with a header row. The text is as follows:

```
TEKLA STRUCTURES MATERIAL LIST
Model:field_NAME
TITLE1
TITLE2
TITLE3
-----
Profile ; Part ; Grade
-----
field_PROFILE ;PART_PO ;field_
-----
-----
```

A blue box highlights the text 'sep=;' at the top left. A green box highlights the header row 'Profile ; Part ; Grade'. A blue box highlights the first data row 'field_PROFILE ;PART_PO ;field_'. A red box highlights the second data row '-----'.

After this addition, the default delimiter no longer depends on you Windows regional settings.

9 Disclaimer

© 2026 Trimble Inc. and affiliates. All rights reserved.

Use of the Software and of this Software Manual are governed by a License Agreement which determines whether you are an authorized user of the Software and the Software Manual. The warranties and disclaimers set forth in the License Agreement apply to the Software and the Software Manual. Neither the Trimble entity granting the license nor any of its affiliates assume responsibility that the text is free of technical inaccuracies or typographical errors. The right to make changes and additions to this manual is reserved.

Trimble and certain product names are registered trademarks of Trimble Inc. in the United States, the European Union and other countries and may have similar statutory protections. Trademarks of third parties are not mentioned in this Manual to suggest an affiliation with or endorsement by their owners.

Elements of the software described in this Manual may be the subject of pending patent applications in the European Union and/or other countries.

Portions of this software:

Portions of this software make use of Open CASCADE Technology software. Open Cascade Express Mesh Copyright © 2019 OPEN CASCADE S.A.S. All rights reserved.

FLY SDK - CAD SDK © 2012 VisualIntegrity™. All rights reserved.

This application incorporates Open Design Alliance software pursuant to a license agreement with Open Design Alliance. Open Design Alliance Copyright © 2002–2020 by Open Design Alliance. All rights reserved.

CADhatch.com © 2017. All rights reserved.

RapidXml C++ library © All rights reserved.

FlexNet Publisher © 2016 Flexera Software LLC. All rights reserved. This product contains proprietary and confidential technology, information and creative works owned by Flexera Software LLC and its licensors, if any. Any use, copying, publication, distribution, display, modification, or transmission of such technology in whole or in part in any form or by any means without the prior express written permission of Flexera Software LLC is strictly prohibited. Except where expressly provided by Flexera Software LLC

in writing, possession of this technology shall not be construed to confer any license or rights under any Flexera Software LLC intellectual property rights, whether by estoppel, implication, or otherwise.

To see the third party open source software licenses, go to Tekla Structures, click **File menu** --> **Help** --> **About Tekla Structures** --> **3rd party licenses** and then click the option.

Index

4	
4D tool, see visualizing project status.....	173
A	
assemblies	
lotting.....	167
reports.....	182
B	
building hierarchy.....	128
C	
cast units	
lotting.....	167
creating	
Excel reports.....	186
multiple reports in one go.....	192
report templates.....	186
reports.....	182
reports of nested assemblies.....	182
reports of selected drawings.....	182
textual templates.....	186
custom phases.....	164
D	
dividing models.....	164
drawings	
reports.....	182
E	
erection sequences.....	164
Excel reports	
creating.....	186
saving.....	186
F	
fonts	
embedding in reports.....	197
reports.....	197
L	
locking	
model objects by phase.....	164
log files	
viewing.....	200
lotting.....	167
M	
models	
dividing into phases.....	164
N	
nested assemblies	
reports.....	182
numbering	
sequences.....	170
O	
Organizer.....	7
calculating property values.....	18
categories.....	35
classification code.....	111
creating categories.....	37,42,43,47,50
creating color sets.....	32
creating custom formulas.....	30

creating custom properties.....	28
creating property templates.....	24
creating subcategories.....	50
customizing.....	57
deleting categories.....	57
deleting property templates.....	33
example of creating categories.....	69
example of creating categories for architectural design.....	118
example of creating categories for structural design.....	117
example of Organizer workflow... 69,117,118,121,123,124	
example of reporting areas.....	88,96
example of reporting project status.....	96
example of tracking object properties..	81
example of using Organizer for precast	124
example of using Organizer to manage assemblies.....	123
example of using Organizer to manage bolts.....	121
excluding objects.....	59
export to IFC.....	111
exporting categories.....	64
exporting object properties.....	20
exporting property templates.....	34
grouping object properties.....	15
importing categories.....	66
importing IFC categories.....	68
importing property templates.....	33
missing objects.....	59
Model Organizer categories.....	67
modifying categories.....	52
multi-user mode.....	68
refresh.....	60
reload.....	60
reporting.....	63
setting units.....	19
setting up.....	57
synchronize.....	60
update database.....	60
viewing object properties.....	8

P

parts	
sequences.....	170

phases.....	164
printing	
reports.....	197
project status visualizations.....	173

R

reports.....	181
adding tabs.....	200
creating.....	182
creating multiple.....	192
creating templates.....	186
CSV.....	182
drafts.....	182
embedding fonts.....	197
entire model.....	182
Excel reports.....	186
fonts.....	197
from all model objects.....	192
from selected model objects.....	192
HTML.....	182
nested assemblies.....	182
PDF.....	182
printing.....	197
selected drawings.....	182
selected model objects.....	182
selecting included objects.....	200
settings.....	182
titles.....	182
tips.....	200
titles in reports.....	182
useful shortcuts in viewing logs and reports.....	200
viewing.....	196,200
XSR.....	182

S

saving	
templates.....	186
selecting	
objects included in reports.....	200
sequences	
user-defined attributes.....	170
settings	
reports.....	182
shortcuts	

in viewing logs and reports.....200

X

XLSX templates.....186

T

tabs
in reports.....200
Task Manager.....139
add objects to tasks.....143
creating tasks.....143
dependencies.....143
export.....158
filtering tasks.....155
Gantt chart.....139
import.....158
link tasks to model.....143
printing.....160
schedule.....143
task properties.....143
track objects.....143
track schedule.....143
user interface.....139
user-defined attributes.....143
viewing tasks.....155
visualizing schedule.....161
Template Editor.....181
templates
creating report templates.....186
creating textual templates.....186
saving.....186
tips.....200
tips
templates and reports.....200

U

unlocking
model objects by phase.....164
user-defined attributes
sequences.....170

V

viewing
reports.....196