



Analyze models

Tekla Structures 2026

March 2026

©2026 Trimble Inc. and affiliates



Contents

1	Get started with structural analysis.....	7
1.1	What is an analysis model.....	7
	Analysis model objects.....	9
1.2	About analysis applications.....	12
1.3	Link Tekla Structures with an analysis application.....	12
1.4	Structural analysis workflow in Tekla Structures.....	13
2	Create and group loads.....	15
2.1	Set the load modeling code.....	17
	Use non-standard load combination factors.....	17
2.2	Group loads together.....	18
	Create or modify a load group.....	19
	Set the current load group.....	20
	Load group compatibility.....	20
	Delete a load group.....	21
2.3	Create loads.....	22
	Define the properties of a load.....	22
	Load magnitude.....	23
	Load form.....	24
	Create a point load.....	25
	Create a line load.....	25
	Create an area load.....	26
	Create a uniform load.....	27
	Create a temperature load or a strain.....	27
	Create wind loads.....	28
	Wind load examples.....	29
3	Distribute and modify loads.....	32
3.1	Attach loads to parts or locations.....	32
3.2	Apply loads to parts.....	33
	Define load-bearing parts by name.....	33
	Define load-bearing parts by selection filter.....	34
	Bounding box of a load.....	34
3.3	Change the loaded length or area of a load.....	35
3.4	Modify the distribution of a load.....	36
3.5	Modify the location or layout of a load.....	38
3.6	Move a load end or corner using handles.....	40
4	Work with loads and load groups.....	41
4.1	Scale loads in model views.....	41

4.2	Check loads and load groups.....	42
	Inquire load properties.....	42
	Find out to which load group a load belongs.....	43
	Find out which loads belong to a load group.....	44
	Check loads using reports.....	44
4.3	Move loads to another load group.....	45
4.4	Export load groups.....	45
4.5	Import load groups.....	46
5	Create analysis models.....	47
5.1	Objects included in analysis models.....	47
	Filters in analysis models.....	48
	Analysis model content.....	48
5.2	Create an analysis model.....	49
	Create an analysis model for all or selected objects.....	50
	Create a modal analysis model.....	50
	Copy an analysis model.....	51
	Delete an analysis model.....	51
6	Modify analysis models.....	52
6.1	Check which objects are included in an analysis model.....	52
6.2	Modify the properties of an analysis model.....	53
	Change the content of an analysis model.....	53
	Define the axis settings of an analysis model.....	54
	Define seismic loads for an analysis model.....	55
	Define modal masses for an analysis model.....	55
	Define the design properties of an analysis model.....	56
	Define analysis model rules.....	57
	Open the Analysis Model Rules dialog.....	57
	Add an analysis model rule.....	57
	Organize analysis model rules.....	58
	Delete analysis model rules.....	59
	Test analysis model rules.....	59
	Save analysis model rules.....	59
6.3	Add objects to an analysis model.....	60
6.4	Remove objects from an analysis model.....	60
6.5	Create an analysis node.....	61
	Status of analysis nodes.....	61
6.6	Create a rigid link.....	63
6.7	Merge analysis nodes.....	63
7	Modify analysis parts.....	65
7.1	About analysis part properties.....	65
7.2	Modify the properties of an analysis part.....	66
7.3	Define end releases and support conditions.....	68
	Define the releases and support conditions of a part end.....	68
	Define the support conditions of a plate.....	69
	Support condition symbols.....	70

7.4	Define design properties for analysis parts.....	71
	Omit analysis parts from design.....	73
	Define the buckling lengths of a column.....	73
	Kmode options.....	74
7.5	Define the location of analysis parts.....	75
	Define or modify the axis location of an analysis part.....	76
	Define offsets for an analysis part.....	77
	Reset the editing of analysis parts.....	78
7.6	Copy an analysis part.....	78
7.7	Delete an analysis part.....	79
8	Combine loads.....	80
8.1	About load combinations.....	80
8.2	Create load combinations automatically.....	81
8.3	Create a load combination.....	82
8.4	Modify a load combination.....	83
8.5	Copy load combinations between analysis models.....	84
	Save load combinations for later use.....	84
	Copy load combinations from another analysis model.....	84
8.6	Delete load combinations.....	85
9	Work with analysis and design models.....	86
9.1	Check warnings about an analysis model.....	86
9.2	Export a model from Tekla Structures to an analysis application.....	89
	Export an analysis model to Tekla Structural Designer.....	89
	Export a physical model to Tekla Structural Designer.....	92
	Export an analysis model to an analysis application.....	92
9.3	Import changes from Tekla Structural Designer to an analysis model....	93
9.4	Merge analysis models using analysis applications.....	96
	Merge analysis models using SAP2000.....	96
	How to merge a Tekla Structures analysis model with a model in SAP2000.....	97
	Reset merged analysis models.....	98
9.5	Save analysis results.....	98
	Save analysis results as user-defined attributes of parts.....	99
9.6	View the analysis results of a part.....	99
9.7	Show analysis class in model views.....	100
9.8	Show analysis bar, member, and node numbers.....	100
9.9	Show the utilization ratio of parts.....	101
10	Analysis and design settings.....	103
10.1	Load group properties.....	103
10.2	Load properties.....	105
	Point load properties.....	105
	Line load properties.....	106
	Area load properties.....	107
	Uniform load properties.....	107
	Temperature load properties.....	108

	Wind load properties.....	109
	Load panel settings.....	110
10.3	Load combination properties.....	112
	Load modeling code options.....	112
	Load combination factors.....	113
	Load combination types.....	114
10.4	Analysis model properties.....	115
10.5	Analysis part properties.....	122
	Analysis class options and colors.....	132
	Analysis axis options.....	135
10.6	Analysis node properties.....	137
10.7	Analysis rigid link properties.....	138
10.8	Analysis bar position properties.....	140
10.9	Analysis area position properties.....	141
10.10	Analysis area edge properties.....	141
11	Disclaimer.....	143

1 Get started with structural analysis

This section explains some basic concepts and procedures you need to know to get started with structural analysis in Tekla Structures.

Click the links below to find out more:

[What is an analysis model \(page 7\)](#)

[About analysis applications \(page 12\)](#)

[Link Tekla Structures with an analysis application \(page 12\)](#)

[Structural analysis workflow in Tekla Structures \(page 13\)](#)

1.1 What is an analysis model

When you use Tekla Structures to model, analyze, and design structures, you will become familiar with the following concepts:

A *physical model* is a structural 3D model that includes the parts you create using Tekla Structures, and information related to them. Each part in the physical model will exist in the completed structure.

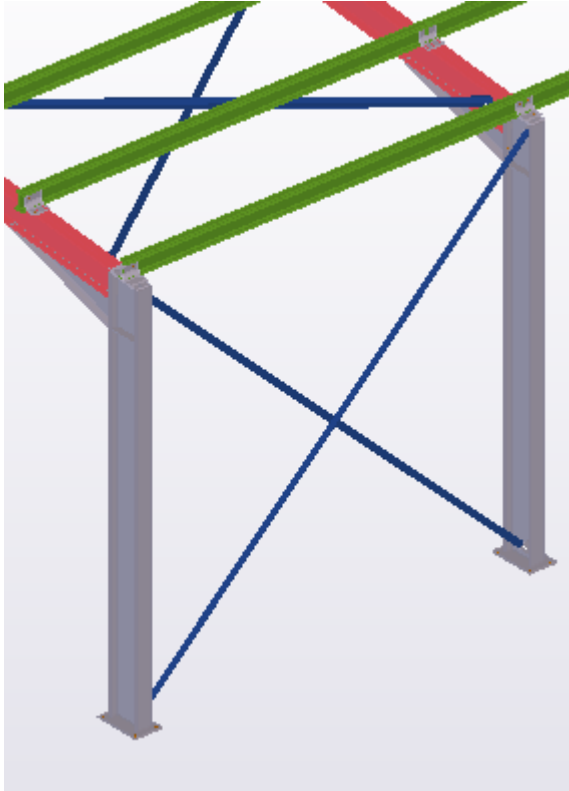

The physical model also contains information about the loads and load groups that act on the physical model parts, and information about the building code that Tekla Structures uses in the load combination process.

An *analysis model* is a structural model that is created from a physical model. It is used for analyzing structural behavior and load bearing, and for design.

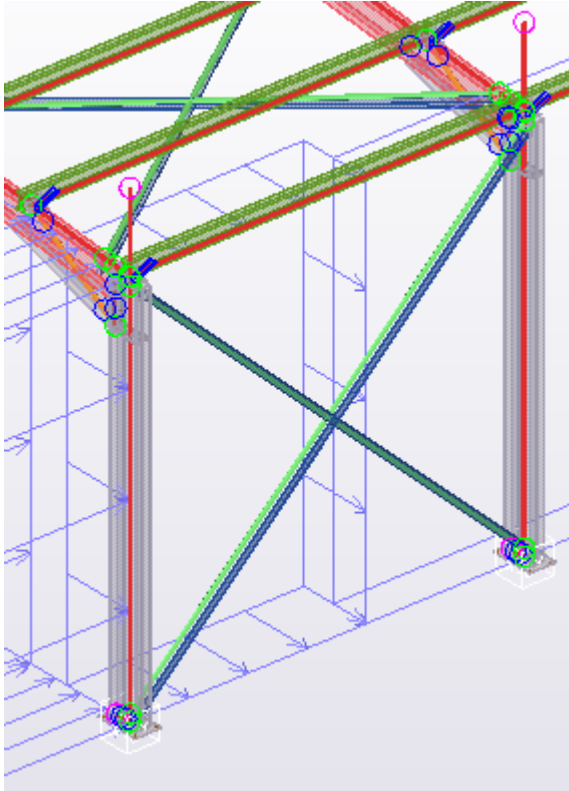

When you create an analysis model, Tekla Structures generates the following analysis objects and includes them in the analysis model:

- Analysis parts, bars, members, and areas of the physical parts
- Analysis nodes
- Support conditions for nodes
- Rigid links between the analysis parts and nodes
- Loads to analysis parts

The analysis model also includes load combinations.

See also

[Analysis model objects \(page 9\)](#)

[Create loads \(page 22\)](#)

[Create analysis models \(page 47\)](#)

Analysis model objects

Analysis model objects are model objects that Tekla Structures creates from physical model objects or on the basis of analysis part connectivity into an analysis model.

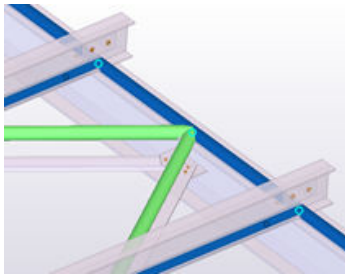
Object	Description
<p data-bbox="309 275 491 309">Analysis part</p> 	<p data-bbox="670 275 1337 342">A representation of a physical part in an analysis model.</p> <p data-bbox="670 360 1294 427">In different analysis models, a physical part is represented by different analysis parts.</p>
<p data-bbox="309 616 480 649">Analysis bar</p>	<p data-bbox="670 616 1337 719">An analysis object that Tekla Structures creates from a physical part (beam, column, or brace) or from a part segment.</p> <p data-bbox="670 736 1329 804">Tekla Structures creates more than one analysis bar from a physical part if:</p> <ul data-bbox="670 822 1315 907" style="list-style-type: none"> <li data-bbox="670 822 1031 855">• The part is a polybeam <li data-bbox="670 873 1315 907">• The part cross section changes non-linearly <p data-bbox="670 925 1329 992">An analysis bar consists of one or more analysis members.</p>
<p data-bbox="309 1003 552 1037">Analysis member</p>	<p data-bbox="670 1003 1315 1070">An analysis object that Tekla Structures creates between two nodes.</p> <p data-bbox="670 1088 1353 1191">Tekla Structures creates more than one analysis member from an analysis bar if the bar intersects with other bars and needs to be split.</p> <p data-bbox="670 1209 1358 1518">Every physical part that you include in an analysis model produces one or more analysis members. A single physical part produces several analysis members if the physical part intersects with other physical parts. Tekla Structures splits the physical part at the intersection points of the analysis axes. For example, a physical model beam that supports two other beams is split into three analysis members between nodes.</p>
<p data-bbox="309 1529 496 1563">Analysis area</p>	<p data-bbox="670 1529 1353 1597">An analysis object that represents a plate, slab, or panel in an analysis model.</p>
<p data-bbox="309 1608 547 1641">Analysis element</p>	<p data-bbox="670 1608 1310 1675">An analysis object that the analysis application creates from an analysis area.</p> <p data-bbox="670 1693 1353 1760">The analysis application creates an element mesh that includes several analysis elements.</p>

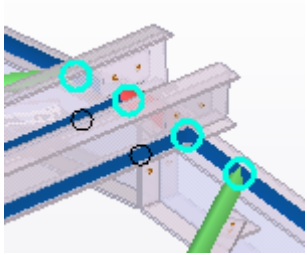
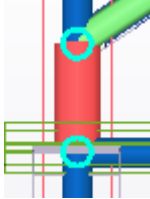
Object	Description
<p data-bbox="309 277 501 309">Analysis node</p> 	<p data-bbox="670 277 1375 376">An analysis object that Tekla Structures creates at a defined point in an analysis model on the basis of analysis part connectivity.</p> <p data-bbox="670 398 1251 430">Tekla Structures creates analysis nodes at:</p> <ul data-bbox="670 452 1251 584" style="list-style-type: none"> <li data-bbox="670 452 1018 483">• The ends of members <li data-bbox="670 506 1251 537">• The intersection points of analysis axes <li data-bbox="670 560 1050 591">• The corners of elements <p data-bbox="670 613 1251 667">You can also manually add analysis nodes (page 61) and merge them (page 63).</p>
<p data-bbox="309 680 437 712">Rigid link</p> 	<p data-bbox="670 680 1375 779">An analysis object that connects two analysis nodes so that they do not move in relation to each other.</p> <p data-bbox="670 801 1331 869">Rigid links have the following properties in Tekla Structures analysis models:</p> <ul data-bbox="670 891 1251 1173" style="list-style-type: none"> <li data-bbox="670 891 1037 922">• Profile = PL300.0*300.0 <li data-bbox="670 945 1091 976">• Material = RigidlinkMaterial <li data-bbox="670 999 893 1030">• Density = 0.0 <li data-bbox="670 1052 1225 1084">• Modulus of elasticity = $100 \cdot 10^9$ N/m² <li data-bbox="670 1106 1005 1137">• Poisson's ratio = 0.30 <li data-bbox="670 1160 1251 1191">• Thermal dilatation coefficient = 0.0 1/K <p data-bbox="670 1214 1331 1267">The analysis application that you use may model rigid links by dedicated rigid link objects.</p> <p data-bbox="670 1290 1315 1321">You can also manually add rigid links (page 62).</p>
<p data-bbox="309 1323 539 1355">Rigid diaphragm</p>	<p data-bbox="670 1323 1375 1422">An analysis object that connects more than two analysis nodes that move with exactly the same rotation and translation.</p>

Some analysis applications work on analysis members whereas others work on analysis bars. This also affects how analysis models are shown in Tekla Structures model views. Either member numbers or bar numbers are shown. The dark blue circles close to the analysis part ends represent pinned part ends.

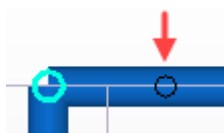

See also

[Modify analysis parts \(page 65\)](#)

[Objects included in analysis models \(page 47\)](#)

[Show analysis bar, member, and node numbers \(page 100\)](#)

1.2 About analysis applications

An *analysis application* is an external analysis and design software that you use with Tekla Structures to analyze and design structures.

The analysis application calculates the forces, moments, and stresses on the structures. It also calculates the displacements, deflections, rotations, and warping of objects under various loading conditions.

Tekla Structures links with a number of analysis applications and also supports export with them in several formats. The analysis application in which you run structural analysis uses data from the Tekla Structures analysis models to generate analysis results.

To analyze Tekla Structures analysis models with an analysis application, you need to install a direct link between Tekla Structures and the analysis application.

See also

[Link Tekla Structures with an analysis application \(page 12\)](#)

1.3 Link Tekla Structures with an analysis application

To use an external analysis application with Tekla Structures analysis models, you need to install a direct link between Tekla Structures and the analysis application.

1. Sign in to your computer as an administrator.
2. Install Tekla Structures if you do not already have it installed.
3. Install the analysis application if you do not already have it installed.
4. Download the link installer for the analysis application.

Many direct links are available for downloading in [Tekla Warehouse](#). For the analysis applications whose direct links are not available in Tekla Warehouse, the links can be downloaded from the vendor web sites or by contacting the vendor.

5. Install the link between Tekla Structures and the analysis application.
6. If needed, install the IFC and CIS/2 formats.

NOTE If you need to uninstall and reinstall Tekla Structures and/or the analysis application for some reason, you will also need to reinstall the link after installing Tekla Structures and/or the analysis application.

See also

[About analysis applications \(page 12\)](#)

1.4 Structural analysis workflow in Tekla Structures

Here is one example of the steps you may need to take when you analyze structures using Tekla Structures and an analysis application. Depending on your project and the analysis application you use, some of the steps may not be needed, some may be repeated or carried out in a different order.

Before you start, create the main load-bearing parts that you need to analyze. There is no need to detail or create connections at this stage. If you have a detailed model, or more parts in the physical model than you need to analyze, you can exclude these parts from the analysis.

1. [Set the load modeling code \(page 16\)](#).
2. [Create load groups \(page 18\)](#).
3. [Create loads \(page 22\)](#).
4. [Create filters \(page 48\)](#) for selecting and adding objects to the analysis model, and for defining secondary analysis parts and braces.
5. If you do not want to create an analysis model of the entire physical and load models, [define which objects to include in the analysis model \(page 47\)](#).

We recommend that you first only include columns in the analysis model to ensure that the columns are aligned.

6. [Create a new analysis model \(page 49\)](#) of the selected parts and loads using the filters you created.
7. [Check the analysis model and analysis parts \(page 52\)](#) in a Tekla Structures model view, and make modifications if needed.
8. [Add \(page 60\)](#) the primary beams and other needed objects to the same analysis model.
9. If needed, [modify the analysis model \(page 52\)](#) or [analysis parts \(page 65\)](#) or their properties. For example, you can:
 - [Define the end releases and support conditions \(page 68\)](#) for analysis parts, and for connections if you have them.
 - Define other analysis properties for individual analysis parts.

- Define design properties.
 - [Add \(page 61\)](#), move, and [merge \(page 63\)](#) analysis nodes.
 - [Create rigid links \(page 62\)](#).
 - [Add \(page 60\)](#) or [remove \(page 60\)](#) parts and/or loads.
10. If needed, create alternative or sub-analysis models.
 11. [Create load combinations \(page 80\)](#).
 12. [Export the analysis model \(page 89\)](#) to the analysis application and run the analysis.
 13. If needed, add special loads and other required settings in the analysis application.
 14. If needed, use the analysis application to postprocess the analysis model or analysis results. For example, you can change part profiles.
After the changes, re-run the analysis.
 15. Import the analysis results to Tekla Structures, [examine \(page 99\)](#) them, and use them in connection design, for example.
 16. If the analysis results required changes to the model in the analysis application, import the changes to Tekla Structures.

See also

[Save analysis results \(page 98\)](#)

2 Create and group loads

This section introduces the different types of loads available in Tekla Structures and explains how to create and group them.

Tekla Structures includes the following load types:

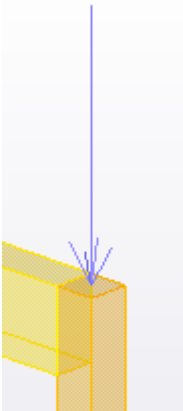
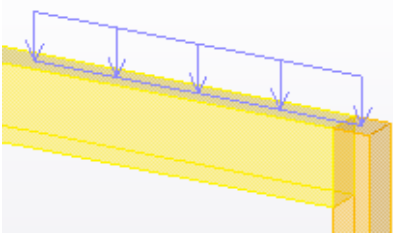
Load type	Description
<p data-bbox="311 882 587 913">Point load (page 25)</p>  A 3D perspective diagram of a yellow rectangular beam. A single blue arrow points vertically downwards from the top surface of the beam, representing a concentrated point load.	<p data-bbox="743 882 1377 947">A concentrated force or bending moment that can be attached to a part.</p>
<p data-bbox="311 1382 572 1413">Line load (page 25)</p>  A 3D perspective diagram of a yellow rectangular beam. A blue line is drawn along the top surface of the beam, with several blue arrows pointing downwards from the line, representing a linearly-distributed load.	<p data-bbox="743 1382 1358 1585">A linearly-distributed force or torsion. By default it runs from a point to another point. You can also create a line load with offsets from the points. A line load can be attached to a part. Its magnitude can vary linearly across the loaded length.</p>

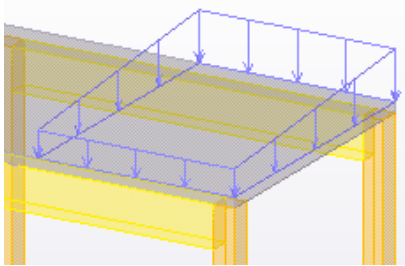
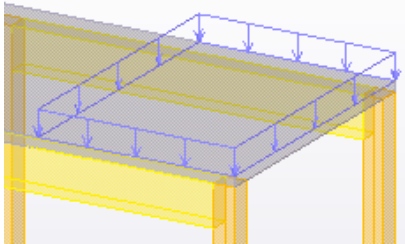
Load type	Description
Area load (page 26) 	A linearly-distributed force bounded by a triangle or quadrangle. You do not have to bind the boundary of the area to parts.
Uniform load (page 26) 	A uniformly-distributed force bounded by a polygon. You do not have to bind the polygon to parts. Uniform loads can have openings.
Wind load (page 28)	Area loads defined by pressure factors, along the height of and on all sides of a building.
Temperature load (page 27)	<ul style="list-style-type: none"> • A uniform change in temperature that is applied to specified parts and that causes axial elongation in parts. • A temperature difference between two surfaces of a part that causes the part to bend.
Strain (page 27)	An initial axial elongation or shrinkage of a part.

To ensure that load analysis is correct, use area and uniform loads for loads on floors. For example, when the layout of beams changes, Tekla Structures recalculates the loads to the beams. It will not do this if you use point or line loads on individual beams. Tekla Structures also distributes area and uniform loads automatically if they act on parts that have openings.

See also

[Set the load modeling code \(page 16\)](#)

[Group loads together \(page 18\)](#)

[Create loads \(page 22\)](#)

[Load properties \(page 105\)](#)

2.1 Set the load modeling code

Load modeling code settings determine the building code, safety factors, and load group types that Tekla Structures uses in the load combination process.

NOTE You should not need to change these settings during the project. If you change the settings, you will also need to change the load group types and check the load combinations.

To set the load modeling code and to use the standard building code specific load combination factors:

1. On the **File** menu, click **Settings** --> **Options** , and go to the **Load modeling** settings.
2. On the **Current code** tab, select a code from the **Load modeling code** list.
3. Check the load combination factors on the appropriate tab.
4. If you use the Eurocode, enter the reliability class factor and select the formula to be used on the **Eurocode** tab.
5. Click **OK**.

See also

[Load modeling code options \(page 112\)](#)

[Load combination factors \(page 113\)](#)

[Use non-standard load combination factors \(page 17\)](#)

Use non-standard load combination factors

If necessary, you can change the values of building code specific load combination factors and create your own settings to be used in the load combination process.

NOTE You should not need to change these settings during the project. If you change the settings, you will also need to change the load group types and check the load combinations.

1. On the **File** menu, click **Settings** --> **Options** , and go to the **Load modeling** settings.
2. On the **Current code** tab, select a code from the **Load modeling code** list that is the most appropriate to your needs.
3. Change the load combination factors on the appropriate tab.
4. Save the settings using a new name.
 - a. Enter a name in the box next to the **Save as** button.

- b. Click **Save as**.

Tekla Structures saves the settings in the `\attributes` folder under the current model folder with the file name extension `.opt`.

To later use the saved settings, select the name of the settings file from the **Load** list, and then click **Load**.

5. Click **OK**.

See also

[Load combination factors \(page 113\)](#)

[Set the load modeling code \(page 16\)](#)

2.2 Group loads together

Each load in a Tekla Structures model has to belong to a *load group*. A load group is a set of loads and loadings that are caused by the same action and to which you want to refer collectively. Loads that belong to the same load group are treated alike during the load combination process.

Tekla Structures assumes that all loads in a load group:

- Have the same partial safety and other combination factors
- Have the same action direction
- Occur at the same time and all together

You can include as many loads as you like in a load group, of any load type.

You need to create load groups because Tekla Structures creates load combinations on the basis of load groups. We recommend that you define the load groups before you create loads. You can define up to 99 load groups in an analysis model.

See also

[Create or modify a load group \(page 18\)](#)

[Set the current load group \(page 19\)](#)

[Load group compatibility \(page 20\)](#)

[Delete a load group \(page 21\)](#)

[Load group properties \(page 103\)](#)

[Work with loads and load groups \(page 41\)](#)

[Combine loads \(page 80\)](#)

Create or modify a load group

You can create a load group by adding a new group or by modifying the default load group. You can modify any existing load group in the same way as the default load group.

Before you start, ensure that you have the appropriate [load modeling code \(page 16\)](#) selected in **File menu** --> **Settings** --> **Options** --> **Load modeling** --> **Current code**.

1. On the **Analysis & design** tab, click **Load groups**.
2. In the **Load Groups** dialog, do one of the following:
 - Click **Add** to create a new load group.
 - Select the default load group from the list to modify it.
 - Select an existing load group from the list to modify it.
3. Click the load group name to modify it.
4. Click the load group type and select a type from the list.
5. Click the load group direction to modify it.
6. To indicate compatibility with existing load groups:
 - a. In the **Compatible** column, enter the number you have used for the load groups that are compatible with this load group.
 - b. In the **Incompatible** column, enter the number you have used for the load groups that are incompatible with this load group.
7. Click the load group color and select a color from the list.

Tekla Structures uses this color when it shows the loads of this load group in the model views.
8. Click **OK** to close the dialog.

See also

[Load group properties \(page 103\)](#)

[Set the current load group \(page 19\)](#)

[Load group compatibility \(page 20\)](#)

[Delete a load group \(page 21\)](#)

[Work with loads and load groups \(page 41\)](#)

Set the current load group

You can define one of the load groups as current. Tekla Structures adds all new loads you create in the current load group.

Before you start, create at least one load group.

1. On the **Analysis & design** tab, click **Load groups**.
2. In the **Load Groups** dialog:
 - a. Select a load group.
 - b. Click **Set current**.

Tekla Structures marks the current load group with the @ character in the **Current** column.

- c. Click **OK** to close the dialog.

See also

[Create or modify a load group \(page 18\)](#)

[Load group properties \(page 103\)](#)

Load group compatibility

When Tekla Structures creates load combinations for structural analysis, it follows the building code you select in **File menu** --> **Settings** --> **Options** --> **Load modeling** --> **Current code**.

To accurately combine loads which have the same load group type, you need to use compatibility indicators (numbers) to identify which load groups:

- Can occur at the same time (are compatible)
- Exclude each other (are incompatible)

Compatible load groups can act together or separately. They can actually be one single loading, for example, a live loading that needs to be split in parts that act on different spans of a continuous beam. Tekla Structures then includes none, one, several, or all of the compatible load groups in a load combination.

Incompatible load groups always exclude each other. They cannot occur at the same time. For example, a wind loading from the x direction is incompatible with a wind loading from the y direction. In load combinations Tekla Structures only takes into account one load group in an incompatible grouping at a time.

Tekla Structures automatically applies basic compatibility facts, such as self-weight being compatible with all other loads, or live loads being compatible with wind load.

Tekla Structures does not combine loads in the x direction with those in the y direction.

Compatibility indicators are all 0 by default. This indicates that Tekla Structures combines the load groups as defined in the building code.

See also

[Load group properties \(page 103\)](#)

[Create or modify a load group \(page 18\)](#)

[Combine loads \(page 80\)](#)

[Set the load modeling code \(page 16\)](#)

Delete a load group

You can delete one or several load groups at a time.

WARNING When you delete a load group, Tekla Structures also deletes all the loads in the load group.

If you try to delete the only load group, Tekla Structures will warn you. At least one load group must exist.

1. On the **Analysis & design** tab, click **Load groups**.
2. In the **Load Groups** dialog:
 - a. Select the load group you want to delete.
To select multiple load groups, hold down the **Ctrl** or **Shift** key.
 - b. Click **Delete**.
3. If there are loads in any of the deleted load groups, Tekla Structures displays a warning dialog.
Do one of the following:
 - Click **Cancel** to **not** delete the load group and the loads in the load group.
 - Click **Delete** to delete the load group and the loads in the load group.

See also

[Group loads together \(page 18\)](#)

[Create or modify a load group \(page 18\)](#)

[Work with loads and load groups \(page 41\)](#)

[Load group properties \(page 103\)](#)

2.3 Create loads

When you create loads, you have two choices: you can set the properties of a load before you create it, or you can modify the properties after you have created a load.

NOTE You cannot attach a load to a part after you have created the load.
You can detach a load from a part after you have created the load.

TIP To create loads perpendicular to sloped parts, you can shift the work plane.

Before you start creating loads, define the load groups and set the current load group.

See also

[Define the properties of a load \(page 22\)](#)

[Create a point load \(page 25\)](#)

[Create a line load \(page 25\)](#)

[Create an area load \(page 26\)](#)

[Create a uniform load \(page 26\)](#)

[Create a temperature load or a strain \(page 27\)](#)

[Create wind loads \(page 28\)](#)

[Distribute and modify loads \(page 32\)](#)

[Work with loads and load groups \(page 41\)](#)

[Group loads together \(page 18\)](#)

[Combine loads \(page 80\)](#)

Define the properties of a load

Before you create a load, it is a good idea to define or check the load properties.

1. On the **Analysis & design** tab, click **Load properties**, and then click a relevant load type.
For example, click **Area load** to define area load properties.
2. In the load properties dialog:
 - a. Enter or modify the properties.
 - Select a load group.
 - Define the load magnitude, and the load form if needed.

- Attach the load to a part or to a position.
You cannot attach a load to a part after you have created the load.
You can detach a load from a part after you have created the load.
 - Define the load-bearing parts.
 - If needed, adjust the loaded length or area.
 - If needed, modify the load distribution on the **Load panel** tab.
- b. Click **OK** to save the properties.

Tekla Structures uses these properties when you create new loads of this type.

See also

[Load properties \(page 105\)](#)

[Load magnitude \(page 23\)](#)

[Load form \(page 24\)](#)

[Distribute and modify loads \(page 32\)](#)

[Group loads together \(page 18\)](#)

Load magnitude

Load magnitude can occur in x, y, and z directions. The coordinate system is the same as the current work plane. Positive coordinates indicate a positive load direction.

For example, when you create loads perpendicular to sloped parts, shifting the work plane helps you to place loads accurately.

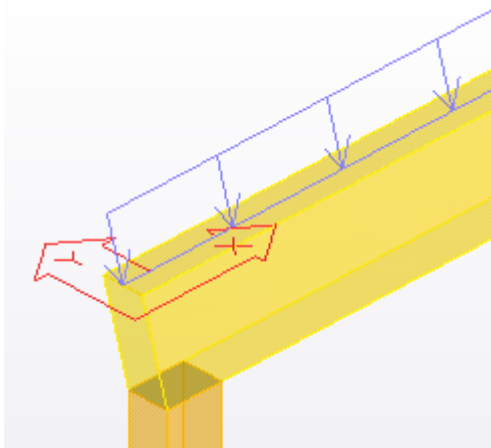

Some load types can have several magnitude values. For example, the magnitude of line loads may vary along the loaded length.

In the load properties dialogs, the following letters denote different magnitude types:

- **P** is for a force acting on a position, along a line, or across an area.
- **M** is for bending moments acting on a position or along a line.
- **T** is for torsional moments acting along a line.

The units depend on the settings in **File menu --> Settings --> Options --> Units and decimals**.

In the load properties dialogs, the numbering of the magnitude values relates to the order in which you pick points when you create loads.





See also

[Load properties \(page 105\)](#)



Load form

Distributed loads (line and area loads) can have different load forms.

The load form of a line load defines how the load magnitude varies along the loaded length. The options are:

Option	Description
	The load magnitude is uniform across the loaded length.
	The load has different magnitudes at the ends of the loaded length. The magnitude changes linearly between the ends.
	The load magnitude changes linearly, from zero at the ends of the loaded length, to a fixed value in the middle of the loaded length.
	The load magnitude changes linearly, from zero at one end of the loaded length, through two (different) values, back to zero at the other end.

The load form of an area load defines the shape of the loaded area. It can be:

Option	Description
	Quadrangular
	Triangular

See also

[Line load properties \(page 106\)](#)

[Area load properties \(page 107\)](#)

Create a point load

You can create a concentrated force or a bending moment acting on a position.

Before you start, shift the work plane if you need to create a load perpendicular to a sloped part.

1. On the **Analysis & design** tab, click **Load properties --> Point load**.
2. In the **Point Load Properties** dialog:
 - a. Enter or modify the load properties.
 - b. On the **Distribution** tab, select whether you want to attach the load to a part.
 - c. Click **OK** to save the changes.
3. On the **Analysis & design** tab, click **Load --> Point load**.
4. If you selected to attach the load to a part, select the part.
5. Pick the position of the load.

See also

[Point load properties \(page 105\)](#)

[Define the properties of a load \(page 22\)](#)

[Attach loads to parts or locations \(page 32\)](#)

Create a line load

You can create a linearly-distributed force or torsion between two points you pick.

Before you start, shift the work plane if you need to create a load perpendicular to a sloped part.

1. On the **Analysis & design** tab, click **Load properties --> Line load**.
2. In the **Line Load Properties** dialog:
 - a. Enter or modify the load properties.
 - b. On the **Distribution** tab, select whether you want to attach the load to a part.
 - c. Click **OK** to save the changes.

3. On the **Analysis & design** tab, click **Load** --> **Line load** .
4. If you selected to attach the load to a part, select the part.
5. Pick the start point of the load.
6. Pick the end point of the load.

See also

[Line load properties \(page 106\)](#)

[Define the properties of a load \(page 22\)](#)

[Attach loads to parts or locations \(page 32\)](#)

Create an area load

Area loads affect triangular or quadrangular areas. If you select the triangular load form, the points you pick define the loaded area. To create a quadrangular load form, pick three points, and Tekla Structures automatically determines the fourth corner point.

Before you start, shift the work plane if you need to create a load perpendicular to a sloped part.

1. On the **Analysis & design** tab, click **Load properties** --> **Area load** .
2. In the **Area Load Properties** dialog:
 - a. Enter or modify the load properties.
 - b. On the **Distribution** tab, select whether you want to attach the load to a part.
 - c. Click **OK** to save the changes.
3. On the **Analysis & design** tab, click **Load** --> **Area load** .
4. If you selected to attach the load to a part, select the part.
5. Pick three corner points for the load.

See also

[Area load properties \(page 107\)](#)

[Define the properties of a load \(page 22\)](#)

[Attach loads to parts or locations \(page 32\)](#)

Create a uniform load

Uniform load is an area load distributed uniformly on a polygonal area. The bounding polygon is defined by at least three corner points you pick. Uniform loads can have openings.

Before you start, shift the work plane if you need to create a load perpendicular to a sloped part.

1. On the **Analysis & design** tab, click **Load properties --> Uniform load** .
2. In the **Uniform Load Properties** dialog:
 - a. Enter or modify the load properties.
 - b. On the **Distribution** tab, select whether you want to attach the load to a part.
 - c. Click **OK** to save the changes.
3. On the **Analysis & design** tab, click **Load --> Uniform load** .
4. If you selected to attach the load to a part, select the part.
5. Pick three corner points for the load.
6. If needed, pick more corner points.
7. Pick the first point again.
8. If you want to create an opening:
 - a. Pick the corner points of the opening.
 - b. Pick the first point of the opening again.
9. Click the middle mouse button to finish picking.

See also

[Uniform load properties \(page 107\)](#)

[Define the properties of a load \(page 22\)](#)

[Attach loads to parts or locations \(page 32\)](#)

Create a temperature load or a strain

You can model a temperature change in a part, or a temperature difference between two part surfaces, or a strain.

1. On the **Analysis & design** tab, click **Load properties --> Temperature load** .
2. In the **Temperature Load Properties** dialog:
 - a. Enter or modify the load properties.
 - b. On the **Magnitude** tab, do one of the following:

- Use the **Temperature difference** section to define a temperature load.
If you want to apply a temperature load to an entire structure, enter the load in the **Temperature change for axial elongation** box.
 - Use the **Strain** section to define a strain.
- c. On the **Distribution** tab, select whether you want to attach the load to a part.
If you want to apply a temperature load to an entire structure, adjust the bounding box to surround all the beams and columns in the structure.
 - d. Click **OK** to save the changes.
3. On the **Analysis & design** tab, click **Load** --> **Temperature load** .
 4. If you selected to attach the load to a part, select the part.
 5. Pick the start point of the load.
 6. Pick the end point of the load.

See also

[Temperature load properties \(page 108\)](#)

[Define the properties of a load \(page 22\)](#)

[Attach loads to parts or locations \(page 32\)](#)

Create wind loads

You can model the effects of wind on a building.



1. On the **Analysis & design** tab, click **Load properties** --> **Wind load** .
2. In the **Wind Load Generator (28)** dialog:
 - a. Enter or modify the [load properties \(page 109\)](#).
 - b. Click **OK** to save the changes.
3. On the **Analysis & design** tab, click **Load** --> **Wind load** .
4. Pick points to indicate the shape of the building on the bottom level.
5. Click the middle mouse button to finish.

Tekla Structures does the following automatically:

- Creates area loads to model the effects of wind
- Creates [load groups \(page 18\)](#) for wind loads
- Includes wind loads in [load combinations \(page 80\)](#)

- Distributes wind loads if they act on plates, slabs, or panels that have openings

TIP To select or modify existing wind loads in the model:

- Use the **Select components** switch  and the **Wind Load Generator (28) dialog (page 109)** for all loads created as a group.
 - Use the **Select objects in components** switch  and the **Area Load Properties dialog (page 107)** for individual loads in a group.
-

See also

[Wind load examples \(page 29\)](#)

Wind load examples

Here are examples on how you can use **Wind Load Generator (28)** to create wind loads.

Example 1

In this example, there are concentrated wind loads at the corners of a building.

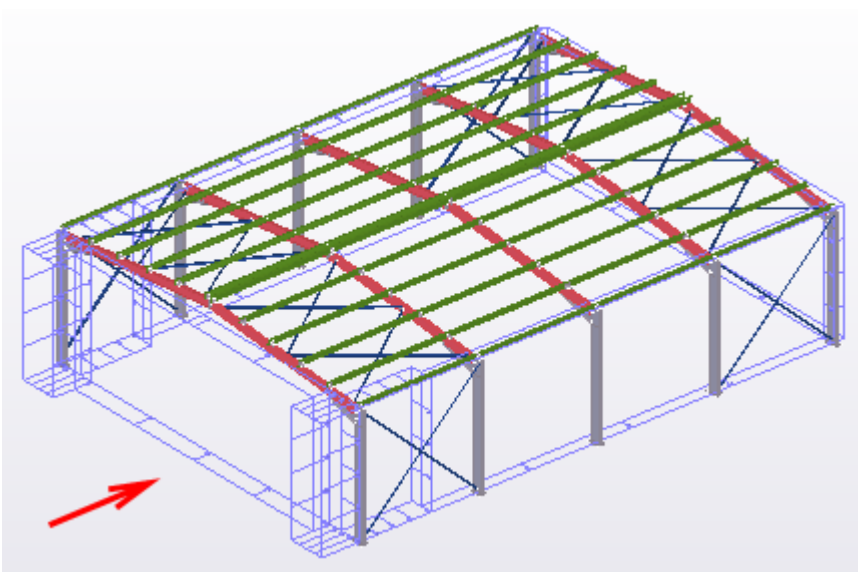

The loads induced by the wind in the global x direction are multiplied by 3 at both corners of wall 1 (windward wall), and at the other corner of walls 2 and 4 (side walls). The zone widths are defined by using dimensions.

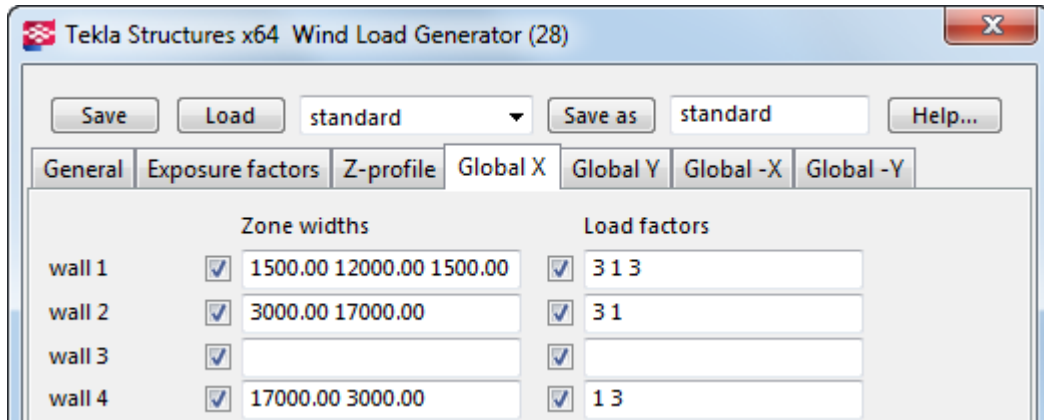

The walls are numbered according to the picking order of the building shape. In this example, points were picked clockwise starting from the bottom left corner of the building.

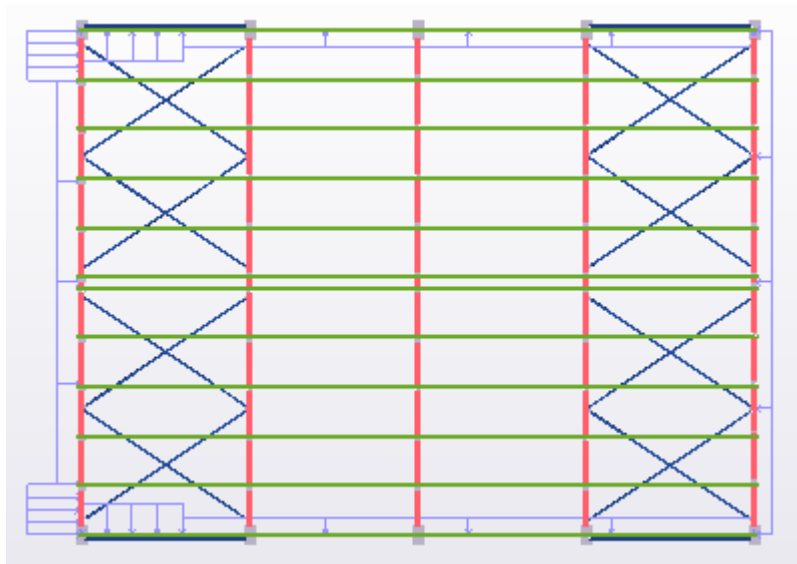

Example 2

In this example, wind loads vary along the height of the building.

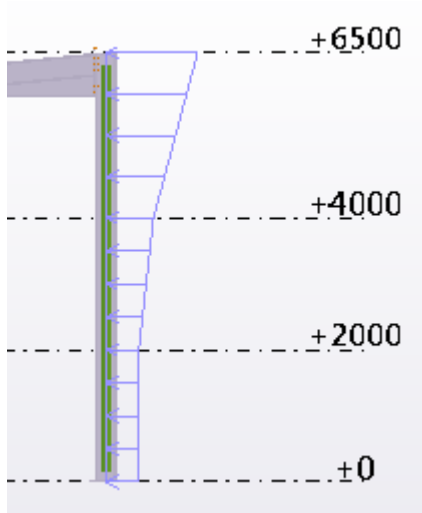

The z profile is defined in terms of pressure factors.

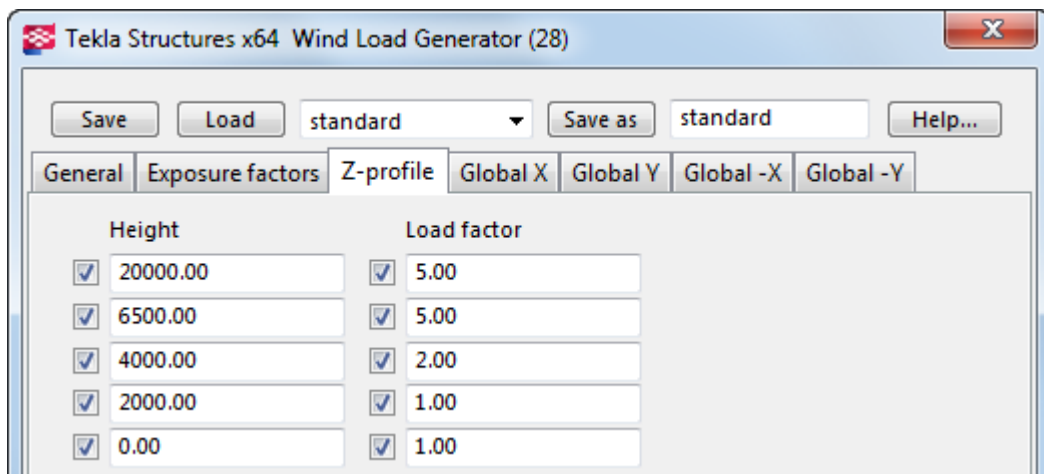

See also

[Create wind loads \(page 28\)](#)

[Wind load properties \(page 109\)](#)

3 Distribute and modify loads

This section explains how Tekla Structures distributes loads to parts and how you can modify loads and load distribution.

Click the links below to find out more:

[Attach loads to parts or locations \(page 32\)](#)

[Apply loads to parts \(page 33\)](#)

[Change the loaded length or area of a load \(page 35\)](#)

[Modify the distribution of a load \(page 36\)](#)

[Modify the location or layout of a load \(page 37\)](#)

[Move a load end or corner using handles \(page 40\)](#)

3.1 Attach loads to parts or locations

You can attach loads to parts or locations for modeling purposes.

Attaching a load to a part binds the load and the part together in the model. If the part is moved, copied, deleted, etc., it affects the load. For example, you can attach a prestressing load to a part, so that the load moves with the part, and disappears if the part is deleted.

If you do not attach a load to a part, Tekla Structures fixes the load to the positions you pick when you create the load.

NOTE You cannot attach a load to a part after you have created the load.
You can detach a load from a part after you have created the load.

See also

[Apply loads to parts \(page 33\)](#)

3.2 Apply loads to parts

To apply loads in a structural analysis model, Tekla Structures searches for parts in the areas that you specify. For each load, you can define the load-bearing parts by name or selection filter, and the search area (the bounding box of the load).

Define load-bearing parts by name

You can list the parts that carry a load or the parts that do not carry a load.

1. Double-click the load that you want to distribute to parts.
The load properties dialog opens.
2. On the **Distribution** tab:
 - a. In the **Load-bearing parts** list, select one of the following:
 - **Include parts by name** to define the parts that carry the load.
 - **Exclude parts by name** to define the parts that do not carry the load.
 - b. Enter the part names.
You can use wildcards when listing the part names.
3. Click **Modify** to save the change.

Example

In this example, braces do not carry this uniform load:

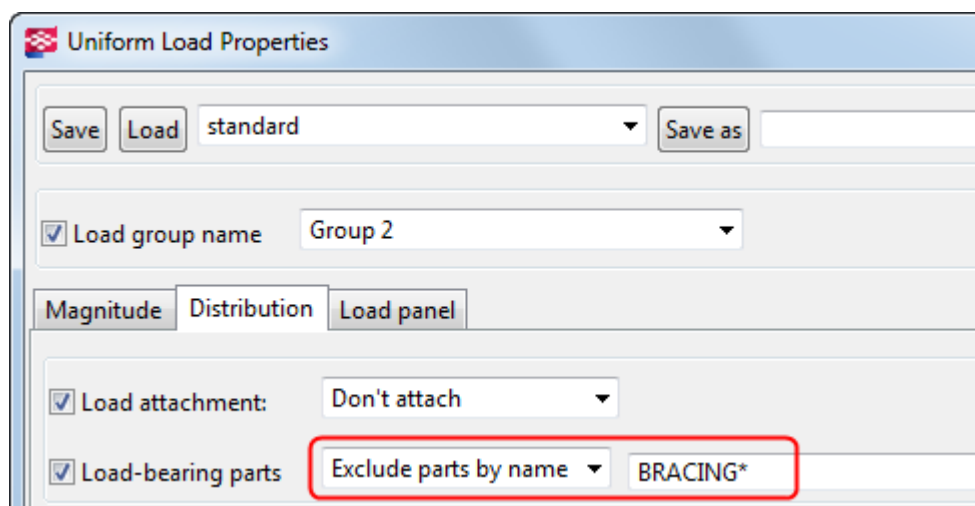

Define load-bearing parts by selection filter

You can define the load-bearing parts by using selection filters.

Before you start, check if there is a selection filter available that suits your needs. If not, create one.

1. Double-click the load that you want to distribute to parts.
The load properties dialog opens.
2. On the **Distribution** tab:
 - a. In the **Load-bearing parts** list, select one of the following:
 - **Include parts by filter** to define the parts that carry the load.
 - **Exclude parts by filter** to define the parts that do not carry the load.
 - b. Select the selection filter in the second list.
3. Click **Modify** to save the changes.

Example

In this example, parts that match the **Beam_Steel** filter carry this uniform load:

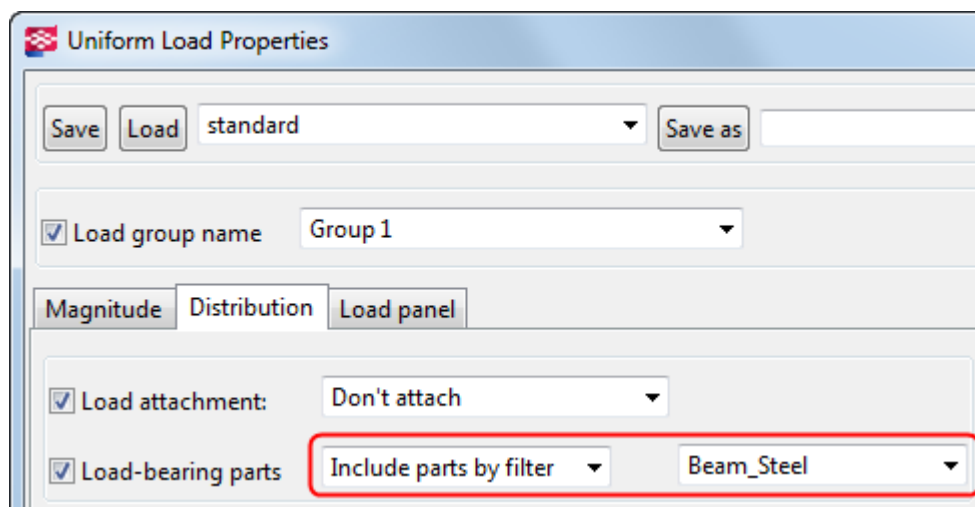

Bounding box of a load

A *bounding box* is the volume around a load where Tekla Structures searches for load-bearing parts.

In addition to selection filters or part name filters, you can use a load's bounding box to search for the parts that carry the load.

Each load has its own bounding box. You can define the dimensions of a bounding box in the x, y, and z directions of the current work plane. The dimensions are measured from the reference point, line, or area of the load.

Offset [distances \(page 35\)](#) from the reference line or area do not affect the size of the bounding box.

3.3 Change the loaded length or area of a load

If a line, area, or uniform load affects a length or an area that is difficult to select in the model, select a length or an area close to it. Then define offset distances from the load reference points to set the length or area. You can shorten, lengthen, or divide the loaded length, and enlarge or reduce the loaded area. Offset distances only apply to the outer edges of loads, not the openings in uniform loads.

To define offset distances for a load:

1. Double-click a load to open its properties dialog.
2. On the **Distribution** tab, enter the distance values in the **Distances** boxes:
 - To shorten or divide the length of a line load, enter positive values for **a** and/or **b**.
 - To lengthen a line load, enter negative values for **a** and/or **b**.

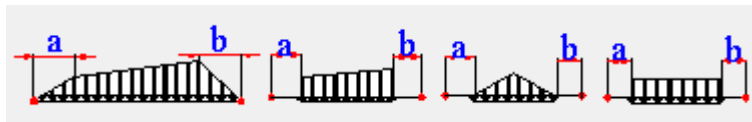

- To enlarge an area load or a uniform load, enter a positive value for **a**.
- To reduce an area load or a uniform load, enter a negative value for **a**.

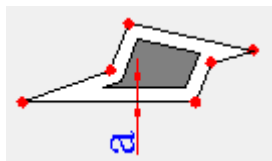

3. Click **Modify** to save the changes.

See also

[Modify the location or layout of a load \(page 37\)](#)

[Move a load end or corner using handles \(page 40\)](#)

3.4 Modify the distribution of a load

You can modify the way Tekla Structures distributes loads.

1. Double-click a load to open its properties dialog.
2. Go to the **Load panel** tab.
3. In the **Spanning** list, select whether to distribute the load in one or two directions.
4. If you set **Spanning** to **Single**, define the primary axis direction. If you set **Spanning** to **Double**, you need to define the primary axis direction to be able to manually define the primary axis weight.

Do one of the following:

- To align the primary axis direction with a part, click **Parallel to part** or **Perpendicular to part**, and then select the part in the model.
- To distribute the load in the global x, y, or z direction, enter 1 in the corresponding **Primary axis direction** box.
- To distribute the load between several global directions, enter the components of the direction vector in the relevant **Primary axis direction** boxes.

To check the primary axis direction of a selected load in a model view, click **Show direction on selected loads**. Tekla Structures indicates the primary direction using a red line.

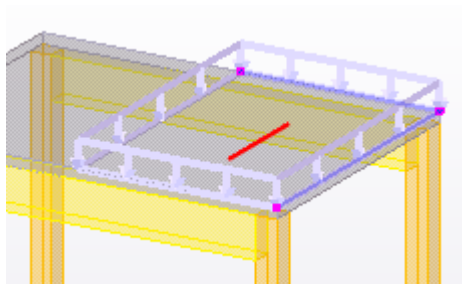

5. In the **Automatic primary axis weight** list, select whether Tekla Structures automatically weights the primary direction in load distribution. If you select **No**, enter a value in the **Weight** box.
6. In the **Load dispersion angle** box, define the angle by which the load is projected onto the surrounding parts.
7. In the **Use continuous structure load distribution** list of a uniform load, define the distribution of support reactions in the first and last spans of continuous slabs.

- Select **Yes** for the 3/8 and 5/8 distribution.

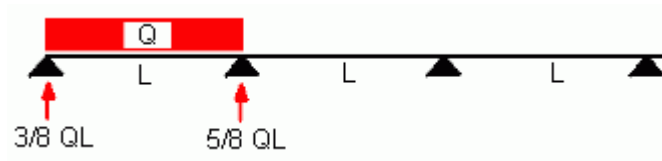

- Select **No** for the 1/2 and 1/2 distribution.

8. Click **Modify** to save the changes.

Example

When using double spanning, automatic primary axis weight and the weight value affect the proportions of the load which is applied to the primary axis and to the perpendicular axis.

- If **Automatic primary axis weight** is **Yes**, the proportions will be in proportion to the third power of the span lengths in these two directions. This means that the shorter the span, the bigger the proportion of the load. The **Weight** value does not matter.

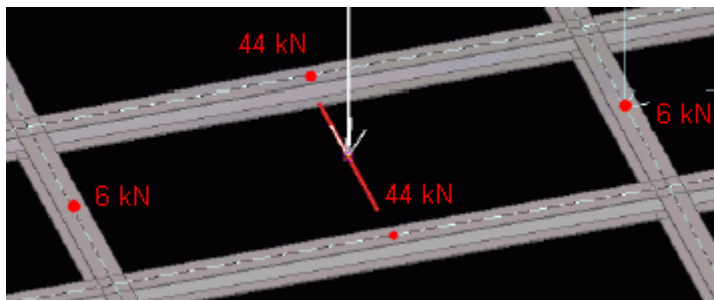

- If **Automatic primary axis weight** is **No**, the given **Weight** value (0.50 in this example) is used to divide the load.

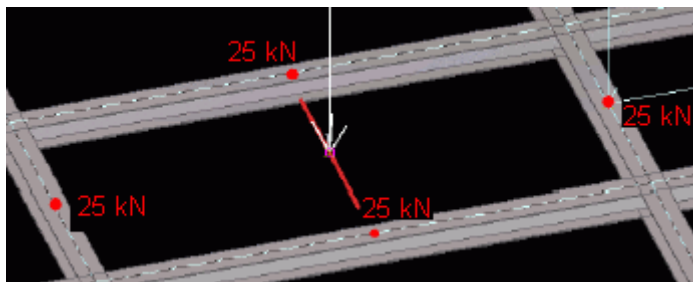

See also

[Load panel settings \(page 110\)](#)

[Distribute and modify loads \(page 32\)](#)

3.5 Modify the location or layout of a load

You can modify the location or layout of loads using direct modification.



Before you start:



- Ensure that the  **Direct modification** switch is active.
- Select the load.

Tekla Structures displays the handles and dimensions that you can use to modify the load.

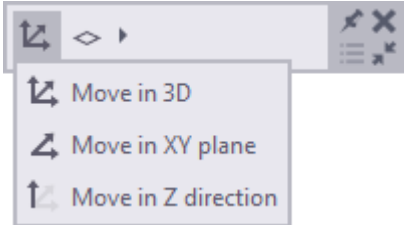
When you select a handle and move the mouse pointer over , Tekla Structures displays a toolbar with more modification options. The available options depend on the type of the load you are modifying.

To modify the location or layout of a load:

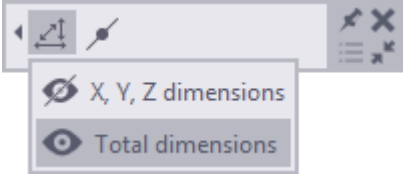
To	Do this	Available for
Set a load reference point to move in one, two, or any direction	<ol style="list-style-type: none"> 1. Select the handle in the load reference point. 2. To define in which directions the handle can move, select an option from the list on the toolbar: <div data-bbox="646 1115 1050 1339" style="border: 1px solid gray; padding: 5px; margin: 10px 0;">  </div> <p>You can also press Tab to cycle through the options.</p> 3. To move the handle in a certain plane only, click  and select the plane. 	Point loads, line loads, area loads, temperature loads, wind loads
Move a point load or a load end or corner	Drag the handle in the load reference point to a new location.	All loads
Move a line load or a load edge	Drag a line handle to a new location.	Line loads, area loads, uniform loads, temperature loads, wind loads

To	Do this	Available for
Show or hide direct modification dimensions	<ol style="list-style-type: none"> 1. Select a handle. 2. On the toolbar, click . 3. Click the eye button to show or hide orthogonal and total dimensions: 	Line loads, area loads, uniform loads, temperature loads, wind loads
Change a dimension	<p>Drag a dimension arrowhead to a new location, or:</p> <ol style="list-style-type: none"> 1. Select the dimension arrowhead which you want to move. To change the dimension at both ends, select both arrowheads. 2. Using the keyboard, enter the value with which you want the dimension to change. To start with the negative sign (-), use the numeric keypad. To enter an absolute value for the dimension, first enter \$, then the value. 3. Press Enter, or click OK in the Enter a Numeric Location dialog. 	Line loads, area loads, uniform loads, temperature loads, wind loads
Show or hide the midpoint handles of a uniform load	<ol style="list-style-type: none"> 1. Select a handle. 2. On the toolbar, click . 	Uniform loads
Add corner points to a uniform load	<p>Drag a midpoint handle  to a new location.</p>	Uniform loads
Remove points from a uniform load	<ol style="list-style-type: none"> 1. Select one or more reference points. 2. Press Delete. 	Uniform loads

See also

[Move a load end or corner using handles \(page 40\)](#)

3.6 Move a load end or corner using handles

Tekla Structures indicates the ends and corners of loads with handles. You can use these handles to move load ends and corners when you do not want to use direct modification.

1. Ensure that the **Direct modification** switch  is **not** active.
2. Select a load to display its handles.

When you select a load, the handles are magenta. For line loads, the handle of the first end is yellow.

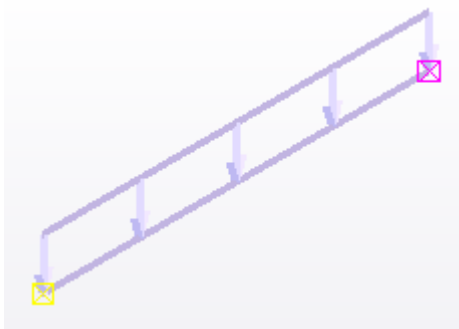

3. Click the handle you want to move.
Tekla Structures highlights the handle.
4. Move the handle like any other object in Tekla Structures.
If you have the **Drag & drop** checkbox selected in **File menu** --> **Settings** --> **Switches**, just drag the handle to a new position.

See also

[Modify the location or layout of a load \(page 37\)](#)

4 Work with loads and load groups

This section explains how to work with loads and load groups.
Click the links below to find out more:

[Scale loads in model views \(page 41\)](#)

[Check loads and load groups \(page 42\)](#)

[Move loads to another load group \(page 44\)](#)

[Export load groups \(page 45\)](#)

[Import load groups \(page 46\)](#)

[Create and group loads \(page 15\)](#)

4.1 Scale loads in model views

You can have Tekla Structures scale loads when you are modeling. This ensures that loads are not too small to see, or so large that they hide the structure.

1. On the **File** menu, click **Settings** --> **Options** , and go to the **Load modeling** settings.
2. On the **Arrow length** tab, enter the minimum and maximum sizes for load types.
3. Click **OK**.

Example

Define that point loads with magnitude of 1 kN or less are 500 mm high in the model, and that point loads with magnitude of 10 kN or more are 2500 mm high. Tekla Structures linearly scales all point loads that have magnitudes between 1 kN and 10 kN between 500 mm and 2500 mm.

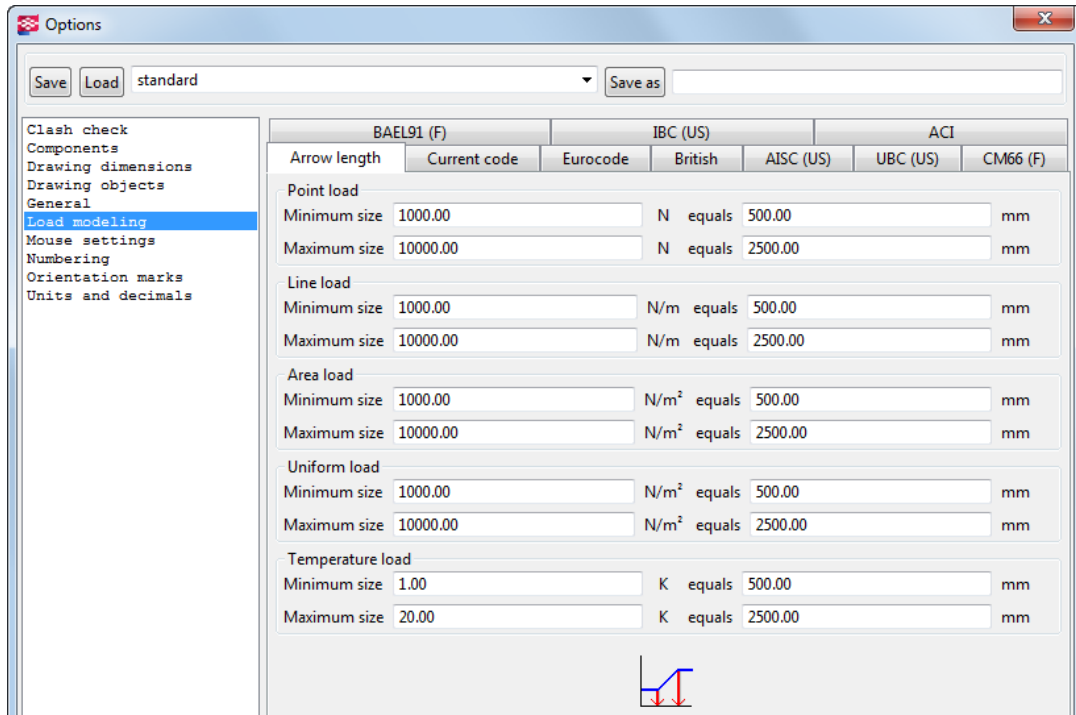

The units depend on the settings in **File menu --> Settings --> Options --> Units and decimals**.

See also

[Work with loads and load groups \(page 41\)](#)

4.2 Check loads and load groups

You can use several methods to check loads and load groups.

Inquire load properties

You can check the load group and the magnitude of a load and show them in a model view. Tekla Structures also shows more information about the load in the **Inquire Object** dialog. If you have an analysis model selected in the **Analysis & Design Models** dialog, Tekla Structures also highlights the parts that carry the load in that analysis model.

1. In the **Analysis & Design Models** dialog, select an analysis model.
2. In a model view, select a load.
3. Right-click and select **Inquire**.

Tekla Structures shows the load group and the magnitude in the model view and highlights the parts that carry the load in the selected analysis model. The **Inquire Object** dialog also opens and shows more information about the load.

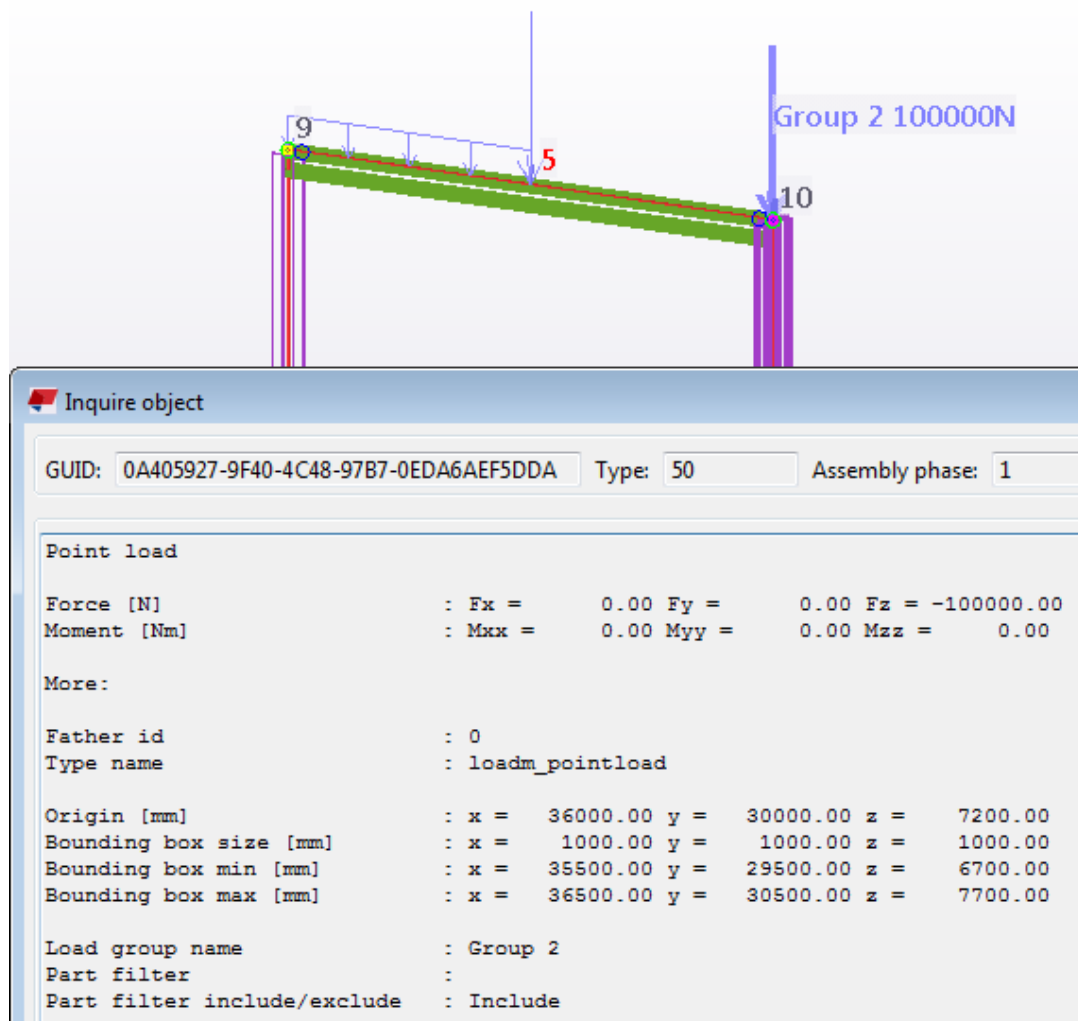

Find out to which load group a load belongs

You can check to which load groups selected loads belong.

1. On the **Analysis & design** tab, click **Load groups**.
2. Select a load in the model.
 To select multiple loads, hold down the **Ctrl** or **Shift** key.
3. In the **Load Groups** dialog, click **Load groups by loads**.
 Tekla Structures highlights the load group in the dialog.

Find out which loads belong to a load group

You can check which loads belong to a selected load group.

1. On the **Analysis & design** tab, click **Load groups**.
2. In the **Load Groups** dialog:
 - a. Select a load group from the list.
 - b. Click **Loads by load groups**.

Tekla Structures highlights the loads of the load group in the model.

Check loads using reports

You can create reports of loads and load groups, and use them to check load and load group information.

When you select a row that contains an ID number in a load report, Tekla Structures highlights and selects the corresponding load in the model.

Tekla Structures includes the following standard report templates for loads and load groups:

- L_Loaded_Part
- L_Loadgroups
- L_Loadgroups_and_loads
- L_Loads
- L_Part_Loads

Example

This example report uses the L_Loadgroups_and_loads template:

```
-----
ENGINEERS LOADGROUP AND LOAD REPORT                                     Page: 1
Tekla Structures                                                       Contract Name: Tekla Corporation
Contract No: 1                                                         Date: 22.03.2013
** PLEASE NOTE THIS REPORT DOES NOT CONSIDER APPLIED MOMENTS **

Result.X      Result.Y      Result.Z
-----
LOAD GROUP NAME = DefaultGroup   LOADGROUP TYPE = Permanent load
-----
LOAD GROUP NAME = Wind load in X  LOADGROUP TYPE = Wind load
-----
Id:19084      Area load      44999          0              0
Id:19086      Area load      119999         0              0
Id:19088      Area load      45000          0              0
Id:19089      Area load      0              45000         0
Id:19092      Area load      0              84978         0
Id:19095      Area load      -75000         0              0
Id:19097      Area load      0              -85000        0
Id:19098      Area load      0              -44935        0
-----
TOTAL FOR LOADGROUP   Wind load in X direc  134998         43             0
-----
```

4.3 Move loads to another load group

You can change the load group of a load, or move several loads at the same time to another load group.

To move loads to another load group, do one of the following:

To	Do this
Change the load group of a load	<ol style="list-style-type: none">1. Double-click a load in the model.2. In the load properties dialog:<ol style="list-style-type: none">a. Select a new load group in the Load group name list.b. Click Modify.
Move loads to another load group	<ol style="list-style-type: none">1. Select the loads in the model.2. On the Analysis & design tab, click Load groups.3. In the Load Groups dialog:<ol style="list-style-type: none">a. Select a load group.b. Click Change load group.

See also

[Group loads together \(page 18\)](#)

[Work with loads and load groups \(page 41\)](#)

4.4 Export load groups

You can export load groups to a file and then use them in another Tekla Structures model.

Before you start, ensure that you have created the relevant load groups.

1. On the **Analysis & design** tab, click **Load groups**.
2. In the **Load Groups** dialog:
 - a. Select the load group or groups to export.
To select multiple load groups, hold down the **Ctrl** or **Shift** key.
 - b. Click **Export**.
3. In the **Export Load Groups** dialog:
 - a. Browse for the folder to which you want to save the load group file.
 - b. Enter a name for the file in the **Selection** box.

- c. Click **OK**.

The file name extension of a load group file is `.lgr`.

See also

[Import load groups \(page 46\)](#)

[Group loads together \(page 18\)](#)

4.5 Import load groups

You can import load groups from another Tekla Structures model if they have been exported to a file.

Before you start, ensure that you have the relevant load groups exported to a file.

1. On the **Analysis & design** tab, click **Load groups**.
2. In the **Load Groups** dialog, click **Import**.
3. In the **Import Load Groups** dialog:
 - a. Browse for the folder where the load group file is.
 - b. Select the load group file (`.lgr`) to import.
 - c. Click **OK**.

See also

[Export load groups \(page 45\)](#)

[Group loads together \(page 18\)](#)

5 Create analysis models

This section explains how to create analysis models in Tekla Structures.

Create the analysis models so that they only contain the main structural parts that you need to analyze and design. Leave out the parts that are not structurally significant.

Click the links below to find out more:

[Objects included in analysis models \(page 47\)](#)

[Filters in analysis models \(page 48\)](#)

[Analysis model content \(page 48\)](#)

[Create an analysis model \(page 49\)](#)

5.1 Objects included in analysis models

You can define which objects to include in an analysis model. Tekla Structures includes or ignores some objects automatically.

The following factors affect which objects Tekla Structures includes in analysis models:

- [Analysis model filter \(page 48\)](#)
- [Analysis model content \(page 48\)](#)
- Which objects you select, [add \(page 60\)](#), [remove \(page 60\)](#), or ignore manually

Tekla Structures ignores the following objects in the analysis, even if you have included them in an analysis model:

- Parts and loads that are filtered out
- Component objects, such as minor parts, bolts, and reinforcing bars
- Parts whose [analysis class \(page 132\)](#) is **Ignore**
- Parts whose [analysis part has been deleted \(page 79\)](#)

The following components set the analysis properties of the parts they create, so these parts **are included** in analysis models:

- **Shed (S57)**
- **Building (S58)** and **(S91)**
- **Slab generation (61)** and **(62)**
- **Truss (S78)**

For example, the vertical and diagonal parts created by **Truss (S78)** are handled as braces in the analysis.

See also

[Check which objects are included in an analysis model \(page 52\)](#)

[Change the content of an analysis model \(page 53\)](#)

Filters in analysis models

You can use an analysis model filter to select parts to be included in an analysis model. You can also use filters to define which of the included parts are considered to be secondary analysis parts or braces in the analysis model.

The following filters are available in the [analysis model properties \(page 115\)](#):

- **Analysis model filter**
- **Bracing member filter**
- **Secondary member filter**

These filters are based on selection filters, and Tekla Structures saves the settings with the analysis model properties. This means that you can check the criteria you used to select objects.

Tekla Structures automatically adds the new objects you create in the physical model to the analysis model if they fulfill the criteria of the analysis model filter and [analysis model content \(page 48\)](#).

TIP Use the analysis model filter to filter out non-structural parts, such as end plates, railings, and ladders, from the analysis model.

See also

[Objects included in analysis models \(page 47\)](#)

Analysis model content

In addition to the analysis model filter, you can define which objects to include in an analysis model by selecting an option for the **Analysis model content** setting.

The available options are:

Option	Description
Selected parts and loads	Only includes selected parts and loads, and parts created by components, when they match the analysis model filter. To later add or remove parts and loads, use the following buttons in the Analysis & Design Models dialog: <ul style="list-style-type: none">• Add selected objects• Remove selected objects
Full model	Includes all main parts and loads, except for parts whose analysis class (page 132) is Ignore . Tekla Structures automatically adds physical objects to the analysis model when they are created and when they match the analysis model filter.
Floor model by selected parts and loads	Only includes selected columns, slabs, floor beams, and loads when they match the analysis model filter. Tekla Structures replaces columns in the physical model with supports.

See also

[Filters in analysis models \(page 48\)](#)

[Create an analysis model \(page 49\)](#)

[Add objects to an analysis model \(page 60\)](#)

[Remove objects from an analysis model \(page 60\)](#)

[Change the content of an analysis model \(page 53\)](#)

5.2 Create an analysis model

There are several methods to create an analysis model in Tekla Structures.

You can create an analysis model that includes all parts and loads you have in a physical model, or that only includes the selected parts and loads. You can also create a new analysis model by copying an existing one, or you can create a modal analysis model.

We recommend that you first only include columns in the analysis model, and check that the columns are aligned. Then add primary beams and other parts as needed.

Create an analysis model for all or selected objects

1. On the **Analysis & design** tab, click **A & D models** to open the **Analysis & Design Models** dialog.
2. Click **New** to open the **Analysis Model Properties** dialog.
3. On the **Analysis model** tab, select the analysis application you want to use from the **Analysis application** list.
4. Enter a unique name for the analysis model.
For example, you can use a name that describes the portion of the physical model you want to analyze.
5. To make the analysis model more accurate, select an option for the following [filters \(page 48\)](#):
 - **Analysis model filter**
 - **Bracing member filter**
 - **Secondary member filter**
6. Select an option for [analysis model content \(page 48\)](#). Whichever option you choose, you can easily [add \(page 60\)](#) and [remove \(page 60\)](#) objects later.
 - **Selected parts and loads**
 - **Full model**
 - **Floor model by selected parts and loads**
7. If you selected **Selected parts and loads** or **Floor model by selected parts and loads**, select the parts and loads in the physical model.
To select the objects, you can use Organizer categories, for example.
Note that if you create an analysis model for selected objects and then use an analysis model filter to leave out more objects, you cannot revert to the originally selected objects, even if you remove the filtering.
8. If needed, define other [analysis model properties \(page 115\)](#).
For example, if you need to run a non-linear analysis, change the analysis method on the **Analysis** tab.
9. Click **OK** to create the analysis model.

Create a modal analysis model

You can create modal analysis models of Tekla Structures models. In modal analysis models, resonant frequency and the associated pattern of structural deformation called mode shapes are determined, instead of performing stress analysis.

1. If you want to create an analysis model for specific parts, select them in the model.
2. On the **Analysis & design** tab, click **A&D models**.
3. In the **Analysis & Design Models** dialog, click **New**.
4. In the **Analysis Model Properties** dialog:
 - a. Define the basic [analysis model properties \(page 115\)](#).
 - b. On the **Analysis** tab, select **Yes** from the **Modal analysis model** list.
 - c. Click **OK**.
5. When needed, [define modal masses \(page 55\)](#) for the analysis model.

Copy an analysis model

You can create copies of existing analysis models. You can then use the copies, for example, to create multiple calculations with different settings.

1. On the **Analysis & design** tab, click **A&D models**.
2. In the **Analysis & Design Models** dialog:
 - a. Select the analysis model to copy.
 - b. Click **Copy**.
Tekla Structures adds the new analysis model to the list with the name **<original model name> - Copy**.
3. Modify the analysis model or analysis parts or their properties as needed.

Delete an analysis model

You can delete unnecessary analysis models.

1. On the **Analysis & design** tab, click **A&D models**.
2. In the **Analysis & Design Models** dialog:
 - a. Select an analysis model.
 - b. Click **Delete**.
3. Click **Yes** to confirm.

6 Modify analysis models

This section explains how to modify analysis models and how to work with analysis model objects.

Click the links below to find out more:

[Check which objects are included in an analysis model \(page 52\)](#)

[Modify the properties of an analysis model \(page 53\)](#)

[Add objects to an analysis model \(page 60\)](#)

[Remove objects from an analysis model \(page 60\)](#)

[Create an analysis node \(page 61\)](#)

[Create a rigid link \(page 62\)](#)

[Merge analysis nodes \(page 63\)](#)

[Create an analysis model \(page 49\)](#)

6.1 Check which objects are included in an analysis model

You can check which parts and loads are included in an analysis model.

1. On the **Analysis & design** tab, click **A&D models**.
2. In the **Analysis & Design Models** dialog:
 - a. Select an analysis model.
 - b. Click **Select objects**.

Tekla Structures highlights and selects the parts and loads in the physical model.

To remove the highlighting, click the view background.

See also

[Objects included in analysis models \(page 47\)](#)

[Add objects to an analysis model \(page 60\)](#)

[Remove objects from an analysis model \(page 60\)](#)

6.2 Modify the properties of an analysis model

1. On the **Analysis & design** tab, click **A&D models**.
2. In the **Analysis & Design Models** dialog:
 - a. Select the analysis model to modify.
 - b. Click **Properties**.
3. In the **Analysis Model Properties** dialog:
 - a. Modify the properties.
 - b. Click **OK** to save the changes.

See also

[Change the content of an analysis model \(page 53\)](#)

[Define the axis settings of an analysis model \(page 54\)](#)

[Define seismic loads for an analysis model \(page 54\)](#)

[Define modal masses for an analysis model \(page 55\)](#)

[Define the design properties of an analysis model \(page 56\)](#)

[Define analysis model rules \(page 57\)](#)

[Analysis model properties \(page 115\)](#)

Change the content of an analysis model

You can change the content of existing analysis models.

If you change the content of an analysis model to **Full model**, Tekla Structures automatically adds all parts and loads in the physical model to the analysis model if they match the analysis model filter.

1. On the **Analysis & design** tab, click **A&D models**.
2. In the **Analysis & Design Models** dialog:
 - a. Select the analysis model to modify.
 - b. Click **Properties**.
3. In the **Analysis Model Properties** dialog:

- a. On the **Analysis model** tab, select the required option from the **Analysis model content list** (page 48).
- b. If needed, modify the **analysis model filter** (page 48) settings.
- c. Click **OK** to save the analysis model properties.

Example

To change the analysis model content from **Full model** to **Selected parts and loads**:

1. **Copy an analysis model** (page 49) that has been created using the **Full model** option.
2. Change the content of the copied analysis model to **Selected parts and loads**.
3. Remove the unwanted parts and loads from the analysis model.

See also

[Remove objects from an analysis model \(page 60\)](#)

[Add objects to an analysis model \(page 60\)](#)

Define the axis settings of an analysis model

You can define and modify the analysis axis settings of an entire analysis model so that the settings apply to all parts in the analysis model.

1. On the **Analysis & design** tab, click **A&D models**.
2. In the **Analysis & Design Models** dialog, do one of the following:
 - To define the axis settings for a new analysis model, click **New**.
 - To modify the axis settings of an existing analysis model, select the analysis model, and then click **Properties**.
3. In the **Analysis Model Properties** dialog:
 - a. In the **Member axis location** list, select an option.
If you select **Model default**, Tekla Structures uses the axis properties of individual analysis parts.
 - b. Click **OK**.

See also

[Define or modify the axis location of an analysis part \(page 76\)](#)

[Define the location of analysis parts \(page 75\)](#)

Define seismic loads for an analysis model

You can define additional lateral seismic loads for analysis models. The seismic loads are created in the x and y directions according to several building codes using a static equivalent approach.

Before you start, ensure that you have the appropriate load modeling code selected in **File menu --> Settings --> Options --> Load modeling --> Current code**.

1. On the **Analysis & design** tab, click **A&D models**.
2. In the **Analysis & Design Models** dialog, do one of the following:
 - To create a new seismic analysis model, click **New**.
 - To modify an existing analysis model, select the analysis model, and then click **Properties**.

The **Analysis Model Properties** dialog opens.

3. On the **Seismic** tab:
 - a. In the **Type** list, select the building code to be used in the seismic analysis to generate seismic loads.
 - b. Define the seismic properties.
4. On the **Seismic masses** tab, define the loads and load groups to be included in the seismic analysis:
 - a. To include the self-weight of parts, select the **Include self weight as seismic mass** checkbox.
 - b. If needed, click **Copy modal analysis masses** to include the same load groups in the seismic analysis as in the modal analysis.
 - c. To move the appropriate load groups to the **Included load groups** table, select them and use the arrow buttons.
 - d. For each load group in the **Included load groups** table, enter a load factor.
5. Click **OK**.

See also

[Analysis model properties \(page 115\)](#)

Define modal masses for an analysis model

You can perform a modal analysis instead of a stress analysis. In the modal analysis, resonant frequencies and the associated patterns of structural deformation called mode shapes are determined. For the modal analysis, you can define modal masses to be used instead of static load combinations.

1. On the **Analysis & design** tab, click **A&D models**.

2. In the **Analysis & Design Models** dialog, do one of the following:
 - To create a new modal analysis model, click **New**.
 - To modify an existing analysis model, select the analysis model, and then click **Properties**.

The **Analysis Model Properties** dialog opens.

3. On the **Analysis** tab, select **Yes** from the **Modal analysis model** list.
This forces Tekla Structures to ignore static load combinations.
4. On the **Modal analysis** tab, define the modal analysis properties and the load groups to be included as masses in the modal analysis:

- a. Enter the count of modes to calculate.
- b. Enter the maximum frequency to calculate.
- c. Select the appropriate **Include self weight** checkboxes to indicate the directions for which Tekla Structures includes the self-weight of parts in the modal analysis.
- d. If suitable, click **Copy seismic masses** to include the same load groups in the modal analysis as in the seismic analysis.
- e. To move the appropriate load groups to the **Included load groups** table, select them and use the arrow buttons.
- f. For each load group in the **Included load groups** table, enter a load factor and set the mass direction.

In the **Mass direction** column, select either:

- **XYZ** to include the load in all three directions.
- **Model default** to include the load only in the direction of the load.

5. Click **OK**.

See also

[Create an analysis model \(page 49\)](#)

[Analysis model properties \(page 115\)](#)

Define the design properties of an analysis model

You can define and modify the design properties of an entire analysis model so that the properties apply to all parts in the analysis model.

1. On the **Analysis & design** tab, click **A&D models**.
2. In the **Analysis & Design Models** dialog, do one of the following:
 - To define the design properties for a new analysis model, click **New**.

- To modify the design properties of an existing analysis model, select the analysis model, and then click **Properties**.
3. In the **Analysis Model Properties** dialog:
 - a. Go to a **Design** tab.

There are separate **Design** tabs for steel, concrete, and timber.
 - b. Select the design code and design method for the material.
 - c. If needed, modify the design properties.

Click an entry in the **Value** column, and then enter a value or select an option.
 - d. Click **OK**.

See also

[Define design properties for analysis parts \(page 71\)](#)

[Analysis model properties \(page 115\)](#)

Define analysis model rules

You can create analysis model rules to define how Tekla Structures handles individual parts when it creates analysis models, and how parts are connected with each other.

Open the Analysis Model Rules dialog

Use the **Analysis Model Rules** dialog to work with the rules of an analysis model.

1. On the **Analysis & design** tab, click **A&D models**.
2. In the **Analysis & Design Models** dialog:
 - a. Select an analysis model.
 - b. Click **Properties**.
3. In the **Analysis Model Properties** dialog, go to the **Analysis model** tab and click **Analysis model rules**.

The **Analysis Model Rules** dialog opens.

Add an analysis model rule

1. Open the **Analysis Model Rules** dialog.
2. Click **Add** to define how two groups of parts are connected with each other in the analysis.

3. In the **Selection filter 1** column, select a filter to define the first part group.
If you need to create a new selection filter that suits your needs, click **Selection filter**.
4. In the **Selection filter 2** column, select a filter to define the second part group.
5. If you want to prevent connections between the part groups, select **Disabled** in the **Status** column.
6. In the **Linkage** column, select one of the following options:
 - (blank): Merges nodes or creates a rigid link.
 - **Merge**: Always merges nodes when parts matching the first selection filter connect with parts matching the second selection filter.
 - **Rigid link**: Creates a rigid link when parts matching the first selection filter connect with parts matching the second selection filter.
 - **Rigid link, moment release at node 1**: Creates a rigid link and a moment release at the nodes of parts matching the first selection filter.
 - **Rigid link, moment release at node 2**: Creates a rigid link and a moment release at the nodes of parts matching the second selection filter.
 - **Rigid link, moment release at both nodes**: Creates a rigid link and moment releases at the nodes of parts matching the first and the second selection filter.
7. Click **OK** to save the rules.
8. In the **Analysis Model Properties** dialog, click **OK** to save the rules as properties of the current analysis model.

Organize analysis model rules

You can change the order of the analysis model rules that you have created for an analysis model. The last rule in the **Analysis Model Rules** dialog overrides the previous ones.

1. Open the **Analysis Model Rules** dialog.
2. Select a rule.
3. To move the rule up in the list, click **Move up**.
To move the rule down in the list, click **Move down**.
4. Click **OK** to save the changes.
5. In the **Analysis Model Properties** dialog, click **OK** to save the rules as properties of the current analysis model.

Delete analysis model rules

You can delete one or more selected analysis model rules from an analysis model.

1. Open the **Analysis Model Rules** dialog.
2. Select the rule or rules to delete.
To select multiple rules, hold down the **Ctrl** or **Shift** key.
3. Click **Remove**.
4. Click **OK** to save the changes.
5. In the **Analysis Model Properties** dialog, click **OK**.

Test analysis model rules

You can test the analysis model rules that you have created on the selected parts before you bring the rules into use.

1. In the model, select the parts on which you want to test the rules.
2. In the **Analysis Model Rules** dialog:
 - a. Click **Test selected parts**.
Tekla Structures opens the **Analysis model rules test** report that lists the IDs of the selected parts, matching selection filters, and the results of using the rules.
 - b. If needed, modify or reorganize the rules and test again.
 - c. When the rules work as you desired, click **OK** to save the rules.
3. In the **Analysis Model Properties** dialog, click **OK** to save the rules as properties of the current analysis model.

Save analysis model rules

You can save analysis model rules for later use in the same or another analysis model.

1. In the **Analysis Model Rules** dialog:
 - a. If needed, save the rules for later use:
Enter a unique name in the box next to the **Save as** button, and then click **Save as**.
Tekla Structures saves the rules file in the `\attributes` folder under the current model folder.
The file name extension of an analysis model rules file is `.adrules`.
 - b. Click **OK**.

2. In the **Analysis Model Properties** dialog, click **OK** to save the rules as properties of the current analysis model.

6.3 Add objects to an analysis model

You can modify existing analysis models by adding parts and loads to them.

1. In the physical model, select the parts and loads to add.
To select the objects, you can use Organizer categories, for example.
2. On the **Analysis & design** tab, click **A&D models**.
3. In the **Analysis & Design Models** dialog:
 - a. Select the analysis model to modify.
 - b. Click **Add selected**.
Tekla Structures adds the selected objects to the selected analysis model.

See also

[Check which objects are included in an analysis model \(page 52\)](#)

[Remove objects from an analysis model \(page 60\)](#)

[Copy an analysis part \(page 78\)](#)

[Create an analysis node \(page 61\)](#)

[Create a rigid link \(page 62\)](#)

6.4 Remove objects from an analysis model

You can modify existing analysis models by removing parts and loads from them.

1. In the physical model, select the parts and loads to remove.
2. On the **Analysis & design** tab, click **A&D models**.
3. In the **Analysis & Design Models** dialog:
 - a. Select the analysis model to modify.
 - b. Click **Remove selected**.
Tekla Structures removes the selected objects from the selected analysis model.

See also

[Check which objects are included in an analysis model \(page 52\)](#)

[Add objects to an analysis model \(page 60\)](#)

[Delete an analysis part \(page 79\)](#)

6.5 Create an analysis node

You can create nodes on analysis parts. The analysis nodes you manually add are not moved with the analysis part if you move the analysis part.

1. On the **Analysis & design** tab, click **A&D models**.
2. In the **Analysis & Design Models** dialog, select the analysis model to which you want to add the node.
3. On the **Analysis & design** tab, click **Node**.
4. Pick the location where you want to add the node.

See also

[Analysis model objects \(page 9\)](#)

[Analysis node properties \(page 137\)](#)



[Status of analysis nodes \(page 61\)](#)







[Merge analysis nodes \(page 63\)](#)

Status of analysis nodes

Analysis nodes can have different status and appearance in analysis models.

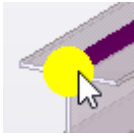
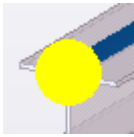
The color, size, and appearance of an analysis node indicate the status of the node, for example, whether the node connects analysis parts and whether the node has been selected.

Status	Color	Appearance	Selection
Node connects at least two analysis parts.	Light aquamarine		(Default)
			Mouse pointer is over the node.
			Node has been selected.

Status	Color	Appearance	Selection
			Mouse pointer is over a related analysis part.
Node is on an analysis part but does not connect it to other analysis parts.	Yellow		(Default)
			Mouse pointer is over the node.
			Node has been selected.
			Mouse pointer is over a related analysis part.
Node is not on any analysis part and it should be deleted.	Red		(Default)
			Mouse pointer is over the node.
			Node has been selected.

See also

[Create an analysis node \(page 61\)](#)

[Analysis node properties \(page 137\)](#)

[Analysis model objects \(page 9\)](#)

[Merge analysis nodes \(page 63\)](#)

6.6 Create a rigid link

A rigid link is an analysis object that connects two analysis nodes so that they do not move in relation to each other. You can manually add rigid links between analysis nodes.

1. On the **Analysis & design** tab, click **A&D models**.
2. In the **Analysis & Design Models** dialog, select the analysis model to which you want to add the rigid link.
3. On the **Analysis & design** tab, click **Rigid link**.
4. Pick the start point for the rigid link.
5. Pick the end point for the rigid link.

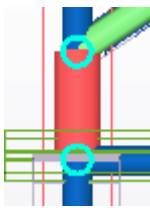

See also

[Analysis model objects \(page 9\)](#)

[Analysis rigid link properties \(page 138\)](#)

[Create an analysis node \(page 61\)](#)

6.7 Merge analysis nodes

You can merge analysis nodes that are located close to each other into a single node.

1. On the **Analysis & design** tab, click **A&D models**.
2. In the **Analysis & Design Models** dialog, select the analysis model in which you want to merge nodes.
3. Select the nodes you want to merge.
4. On the **Analysis & design** tab, click **Merge nodes**.
5. If you are merging nodes on analysis parts that have **Keep axis position** set to **Yes**, Tekla Structures prompts you to change it to **No**. To accept the change, click **Set keep axis as No**.
6. Pick the location to which you want the nodes to be merged.
Tekla Structures merges the nodes into a single node and extends the analysis parts accordingly.

See also

[Create an analysis node \(page 61\)](#)

[Analysis node properties \(page 137\)](#)

[Status of analysis nodes \(page 61\)](#)

7 Modify analysis parts

This section explains how to modify analysis parts and their properties. Click the links below to find out more:

[About analysis part properties \(page 65\)](#)

[Modify the properties of an analysis part \(page 66\)](#)

[Define end releases and support conditions \(page 68\)](#)

[Define design properties for analysis parts \(page 71\)](#)

[Define the location of analysis parts \(page 75\)](#)

[Copy an analysis part \(page 78\)](#)

[Delete an analysis part \(page 79\)](#)

7.1 About analysis part properties

You can view, define, or modify analysis part properties before or after creating analysis models. You can define analysis part properties independently from analysis models, or modify them according to an analysis model. Analysis parts can have different properties in different analysis models.

You can define analysis properties for parts before you create analysis models. Tekla Structures applies the analysis part properties when the parts are added to an analysis model. You can also modify analysis part properties after you have created analysis models.

If you view the analysis properties of a part before you have modified the properties or created any analysis models, Tekla Structures displays the analysis properties according to the part type. For example, all steel beams first have identical analysis properties. These settings are called *current analysis properties*.

If you modify the analysis properties of a part before you create analysis models, Tekla Structures saves the modified settings as the default analysis

properties of the part in the `AnalysisPartDefaults.db6` file under the current model folder. These *default analysis properties* override the current analysis properties and will be used when you add the part to an analysis model.

When you create analysis models and then view the analysis properties of a part, Tekla Structures displays the properties according to the selected analysis model. If you do not have an analysis model selected in the **Analysis & Design Models** dialog, Tekla Structures displays the current analysis properties for unchanged parts and the default analysis properties for modified parts.

See also

[Modify the properties of an analysis part \(page 66\)](#)

7.2 Modify the properties of an analysis part

You can view, define, and modify the properties of analysis parts using the analysis part properties dialog.

To access the properties of an analysis part, do one of the following:

To	Do this
Define or modify the current analysis properties of a part type independently from analysis models	<ol style="list-style-type: none"> 1. On the Analysis & design tab, click Part analysis properties, and then click a relevant part type. 2. In the analysis properties dialog: <ol style="list-style-type: none"> a. Modify the properties. b. Click Apply or OK to save the changes as the current analysis properties of the part type. <p>Tekla Structures will use these current analysis properties for new parts of this type that you create in the model.</p>
Define or modify the default analysis properties of a part independently from analysis models	<ol style="list-style-type: none"> 1. Ensure that you do not have an analysis model selected in the Analysis & Design Models dialog. 2. In the physical model, select a part. 3. Right-click and select Analysis Properties. 4. In the part's analysis properties dialog: <ol style="list-style-type: none"> a. Modify the properties.

To	Do this
	<p>b. Click Modify to save the changes as the default analysis properties of the part in the <code>AnalysisPartDefaults.db6</code> file.</p> <p>Tekla Structures will use these default analysis properties instead of current analysis properties for this part when you add it to an analysis model.</p>
View the analysis properties of a part independently from analysis models	<ol style="list-style-type: none"> 1. Ensure that you do not have an analysis model selected in the Analysis & Design Models dialog. 2. In the physical model, select a part. 3. Right-click and select Analysis Properties. If you have already previously modified the analysis properties of this part, Tekla Structures displays these default analysis properties in the part's analysis properties dialog (for example, Beam Analysis Properties). If you have not modified the analysis properties of this part, Tekla Structures displays the current analysis properties in the part's analysis properties dialog (for example, Beam Analysis Properties - Current properties). 4. In the part's analysis properties dialog: <ol style="list-style-type: none"> a. View the properties. b. Click Cancel to close the dialog.
View or modify the properties of an analysis part in an analysis model	<ol style="list-style-type: none"> 1. On the Analysis & design tab, click A&D models. 2. In the Analysis & Design Models dialog, select an analysis model (for example, <code>AnalysisModel3</code>). 3. In the physical model, select a part. 4. Right-click and select Analysis Properties. 5. In the part's analysis properties dialog (for example, Beam Analysis Properties - AnalysisModel3), do one of the following: <ul style="list-style-type: none"> • View the properties, and then click Cancel to close the dialog. • Modify the properties, and then click Modify to save the changes.

See also

[Analysis part properties \(page 122\)](#)

[About analysis part properties \(page 65\)](#)

7.3 Define end releases and support conditions

In structural analysis, the stresses and deflections of a part depend on how it is supported by, or connected to, other parts. You normally use restraints or springs to model connections. These determine how analysis parts move, deflect, warp, and deform in relation to each other, or to nodes.

Part ends and nodes have degrees of freedom (DOF) in three directions. The displacement of a part end can be free or fixed, and the rotation can be pinned or fixed. If the degree of connectivity is between free, or pinned, and fixed, use springs with different elastic constants to model them.

Tekla Structures uses analysis part, connection, or detail properties to determine how to connect parts in the analysis model.

The analysis part properties determine the degrees of freedom for each end of a part. The first end of a part has a yellow handle, the second end has a magenta handle.

See also

[Define the releases and support conditions of a part end \(page 68\)](#)



[Define the support conditions of a plate \(page 69\)](#)

[Support condition symbols \(page 70\)](#)

Define the releases and support conditions of a part end

Before you start, in the **Analysis & Design Models** dialog, select the analysis model in which you want to define the part end releases and support conditions.

1. Select a part.
2. Right-click and select **Analysis Properties**.
3. In the part's analysis properties dialog:
 - To define the end conditions for the start of the part (yellow handle), go to the **Start releases** tab.
 - To define the end conditions for the end of the part (magenta handle), go to the **End releases** tab.
4. In the **Start** or **End** list, select an option.

The options  and  for a pinned part end are shown as dark blue circles close to the analysis part end in the analysis model.

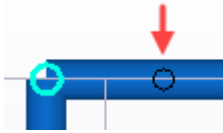

5. If needed for a supported part end, define the rotation.
6. If needed, modify the translational and rotational degrees of freedom.
7. If you selected **Spring** for any of the degrees of freedom, enter the spring constant.

The units depend on the settings in **File menu --> Settings --> Options --> Units and decimals**.

8. If you selected **Partial release** for any of the rotational degrees of freedom, specify the degree of connectivity.

Enter a value between 0 (fixed) and 1 (pinned).

9. Click **Modify**.

See also

[Define the support conditions of a plate \(page 69\)](#)

[Support condition symbols \(page 70\)](#)

[Analysis part properties \(page 122\)](#)

[About analysis part properties \(page 65\)](#)

Define the support conditions of a plate

You can define support conditions for contour plates, concrete slabs, and concrete panels. Tekla Structures creates supports for the bottom edge of a panel, for all edge nodes of a slab or a plate, or for all nodes of a beam. For panels, the bottom edge can be inclined.

Before you start, in the **Analysis & Design Models** dialog, select the analysis model in which you want to define the support conditions.

1. Select a plate.
2. Right-click and select **Analysis Properties**.
3. In the plate's analysis properties dialog:
 - a. On the **Area attributes** tab, select an option in the **Supported** list:
 - **No**: No supports are created.
 - **Simply (translations)**: Only translations are fixed.
 - **Fully**: Both translations and rotations are fixed.
 - b. Click **Modify**.

See also

[Define the releases and support conditions of a part end \(page 68\)](#)

[Support condition symbols \(page 70\)](#)

[Analysis part properties \(page 122\)](#)

[About analysis part properties \(page 65\)](#)

Support condition symbols

Tekla Structures displays symbols for nodes that indicate the support conditions of a node.

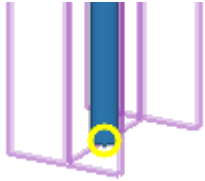
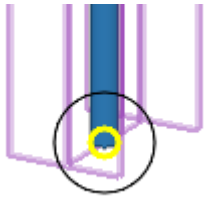
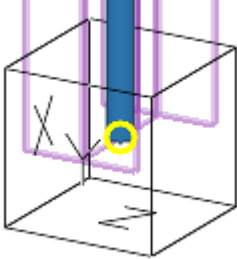
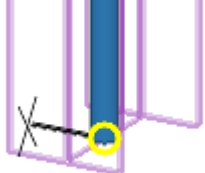
Symbol	Support condition
	No supports
	Pinned connection
	Fixed connection
	Translational direction fixed

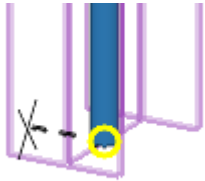
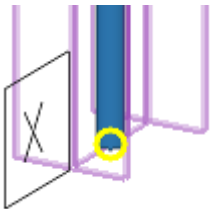
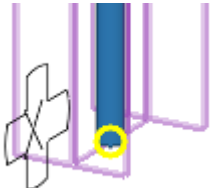
Symbol	Support condition
	Translational direction spring
	Rotational fixed
	Rotational spring

If you do not want to show the support condition symbols in model views, set the advanced option `XS_AD_SUPPORT_VISUALIZATION` to `FALSE` in **File menu** --> **Settings** --> **Advanced Options** --> **Analysis & Design** .

See also

[Define end releases and support conditions \(page 68\)](#)

7.4 Define design properties for analysis parts

You can define design properties for individual analysis parts. Design properties are properties which can vary according to the design code and the material of the part (for example, design settings, factors, and limits).

The properties you see when you first open the **Design** tab in an analysis part properties dialog are the properties that apply to the entire analysis model you have selected in the **Analysis & Design Models** dialog.

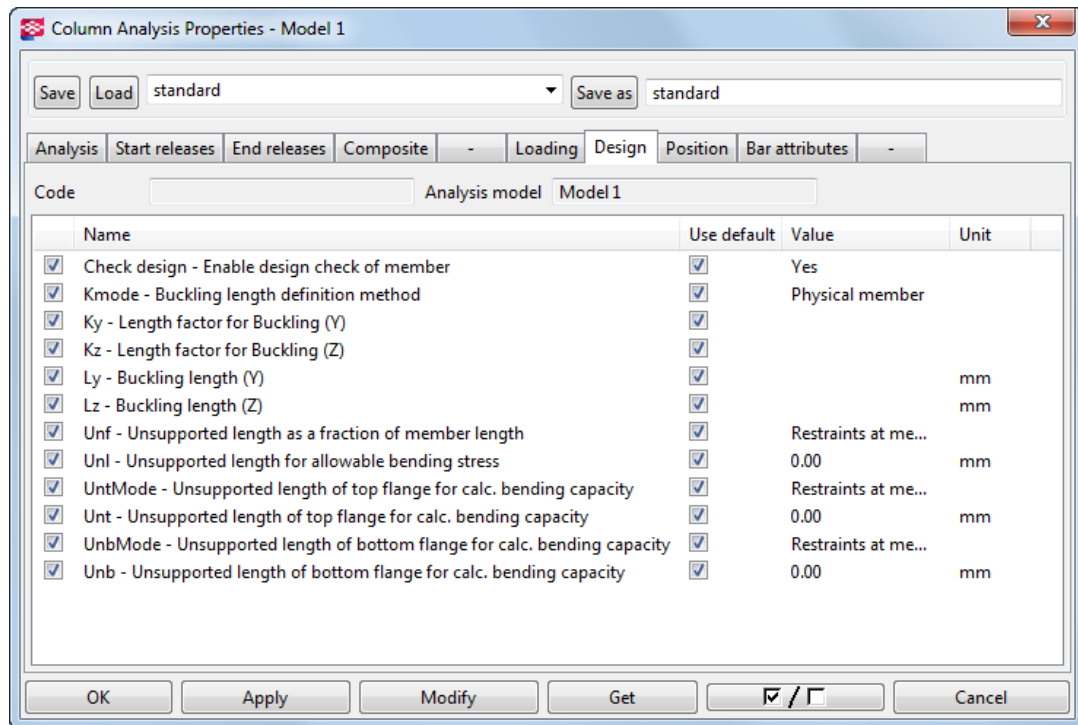

You can modify the design properties of specific analysis parts using the appropriate analysis part properties dialogs. When you change a value or select an option in the **Value** column, the checkbox in the **Use default** column is cleared indicating that the analysis model properties are not in use for this particular analysis part and design property.

Example

If an analysis model contains parts with different material grades, define the most common material grade using the analysis model properties. Then change the material grade of specific parts in the analysis part properties.

See also

[Omit analysis parts from design \(page 72\)](#)

[Define the buckling lengths of a column \(page 73\)](#)

[Define the design properties of an analysis model \(page 56\)](#)

[Analysis part properties \(page 122\)](#)

Omit analysis parts from design

You can omit individual analysis parts from the design check during the analysis.

Before you start, in the **Analysis & Design Models** dialog, select the analysis model in which you want to modify the analysis part properties.

1. In the physical model, select a part.
2. Right-click and select **Analysis Properties**.
3. In the part's analysis properties dialog:
 - a. Go to the **Design** tab.
 - b. In the **Value** column, select **No** for **Check design - Enable design check of member**.
 - c. Click **Modify**.

See also

[Define design properties for analysis parts \(page 71\)](#)

[About analysis part properties \(page 65\)](#)

Define the buckling lengths of a column

You can define buckling lengths for columns and column segments. Column segments represent the building levels. Tekla Structures automatically divides columns into segments at the point where a support in the buckling direction exists, or where the column profile changes.

Effective buckling length is $K \cdot L$, where K is the length factor and L is the buckling length.

A column can have different buckling lengths in different analysis models.

Before you start, in the **Analysis & Design Models** dialog, select the analysis model in which you want to define the buckling lengths.

1. Select a column.
2. Right-click and select **Analysis Properties**.
3. In the column's analysis properties dialog:
 - a. Go to the **Design** tab and the **Value** column.
 - b. Select an option for **Kmode**.
 - c. Enter one or more values for **K - Length factor for buckling** in the y and/or z direction.

The number of values you can enter depends on the option you selected for **Kmode**.

To enter multiple values, enter a value for each column segment starting from the lowest segment, and use spaces to separate the values. You can also use multiplication to repeat factors, for example, 3*2.00.

- | | |
|---|--|
| <input checked="" type="checkbox"/> Kmode - Buckling length definition method | <input type="checkbox"/> Column segment, multiple values |
| <input checked="" type="checkbox"/> Ky - Length factor for Buckling (Y) | <input type="checkbox"/> 1.00 1.50 2.00 |
| <input checked="" type="checkbox"/> Kz - Length factor for Buckling (Z) | <input type="checkbox"/> 1.00 1.50 2.00 |

- d. Enter one or more values for **L - Buckling length** in the y and/or z direction.
 - To automatically calculate length values, leave the fields blank.
 - To override one or more length values, enter values in the relevant buckling length fields. The number of values you need to enter depends on the option you selected for **Kmode**. You can use multiplication to repeat buckling lengths, for example, 3*4000.
- e. Click **Modify**.

See also

[Kmode options \(page 74\)](#)

[About analysis part properties \(page 65\)](#)

Kmode options

Use the **Kmode** options to define how Tekla Structures calculates the buckling lengths of columns.

The options are:

Option	Description
Physical member	L is the length of the column.
Column segment	L is the length of one column segment.
Column segment, multiple values	L is the length of one column segment with user-defined factors and lengths for each column segment.
Analytical member	L is the length of the member in the analysis model.
Analytical member, multiple values	L is the length of the member in the analysis model with user-defined factors and lengths for each member.

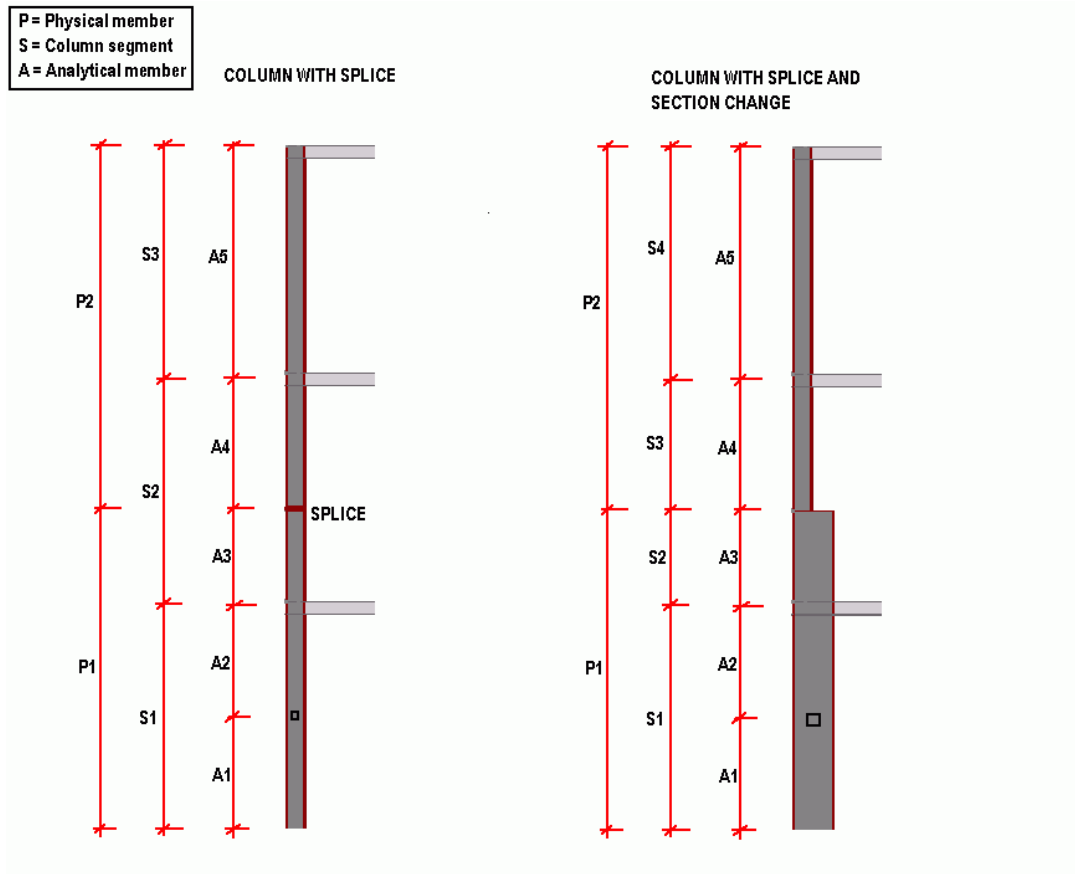

See also

[Define the buckling lengths of a column \(page 73\)](#)

7.5 Define the location of analysis parts

You can define and modify the analysis axis location of individual parts in an analysis model, or you can use the axis settings of the analysis model that apply to all parts in the analysis model.

You can also define offsets for analysis parts and use handles to move analysis parts.

If you move an analysis part handle, you can view the offsets in the following dialogs:

- **Analysis Bar Position Properties**
- **Analysis Area Position Properties**

- **Analysis Area Edge Properties**

If you move a physical part or an analysis part, these handle offsets will be reset. The **Reset editing of selected parts** command also resets the changes you have made using the analysis part handles.

See also

[Define or modify the axis location of an analysis part \(page 76\)](#)

[Define offsets for an analysis part \(page 77\)](#)

[Reset the editing of analysis parts \(page 78\)](#)

[Analysis bar position properties \(page 140\)](#)

[Analysis area position properties \(page 140\)](#)

[Analysis area edge properties \(page 141\)](#)

[Analysis part properties \(page 122\)](#)

[Define the axis settings of an analysis model \(page 54\)](#)

Define or modify the axis location of an analysis part

You can define and modify the analysis axis location of individual parts. The analysis axis defines the location of an analysis part in relation to the corresponding physical part. For example, the analysis part can be located on the neutral axis or the reference line of the physical part.

Before you start:

- In the **Analysis & Design Models** dialog, select the analysis model in which you want to modify the analysis part properties.
 - For the selected analysis model, ensure that **Member axis location** is set to **Model default** in the **Analysis Model Properties** dialog.
1. In the physical model, select a part.
 2. Right-click and select **Analysis Properties**.
 3. In the part's analysis properties dialog:
 - a. Go to the **Position** tab.
 - b. In the **Axis** list, select an option.
 - c. In the **Keep axis position** list, define whether the part's analysis axis can move, and in which direction when the part is connected with other parts.
 - d. If needed, use the **Axis modifier** boxes to define whether the axis is bound to global coordinates, to the nearest grid line, or neither.
 - e. Click **Modify**.

Alternatively, you can modify the analysis axis location of parts by using keyboard shortcuts that move analysis parts in relation to the corresponding physical parts. First select analysis parts in the active analysis model, and then use the following keyboard shortcuts:

- To move the analysis parts up, press **Alt+arrow up**.
- To move the analysis parts down, press **Alt+arrow down**.
- To move the analysis parts to the left, press **Alt+arrow left**.
- To move the analysis parts to the right, press **Alt+arrow right**.

See also

[Define offsets for an analysis part \(page 77\)](#)

[Analysis part properties \(page 122\)](#)

[About analysis part properties \(page 65\)](#)

[Define the axis settings of an analysis model \(page 54\)](#)

Define offsets for an analysis part

You can define offsets for an analysis part. Offsets move the analysis part in relation to the default location of the analysis axis.

Before you start, in the **Analysis & Design Models** dialog, select the analysis model in which you want to define offsets.

1. In the physical model, select a part.
2. Right-click and select **Analysis Properties**.
3. In the part's analysis properties dialog:
 - a. Go to the **Position** tab.
 - b. In the **Offset** boxes, define the offset of the analysis part from the physical part's analysis axis in the global x, y, and z directions.

These values change if you move the analysis part in the model.

These values do not reset if you move the physical part.
 - c. In the **Longitudinal offset mode** list, select whether the longitudinal end offsets **Dx** of the physical part are taken into account.

End offsets determine where Tekla Structures creates the end nodes of the analysis part.
 - d. Click **Modify**.

See also

[Define or modify the axis location of an analysis part \(page 76\)](#)

[Analysis part properties \(page 122\)](#)

Reset the editing of analysis parts

If you have changed the location of analysis parts using handles, you can reset the selected analysis parts to the default analysis settings.

1. On the **Analysis & design** tab, click **A&D models**.
2. In the **Analysis & Design Models** dialog, select the analysis model in which you want to reset parts.
3. Select the parts to reset.
4. On the **Analysis & design** tab, click **Reset editing of selected parts**.

See also

[Define the location of analysis parts \(page 75\)](#)

[Modify analysis parts \(page 65\)](#)

7.6 Copy an analysis part

You can create copies of existing analysis parts together with the applied properties and node offsets.

For example, you can use copying to apply analysis settings to multiple repeated frames. First apply the correct analysis settings to one frame. Then copy the settings to other similar frames.

1. On the **Analysis & design** tab, click **A&D models**.
2. In the **Analysis & Design Models** dialog, select the analysis model that includes the part you want to copy and uses the analysis part properties you want to use.
3. In the physical model, select the part to copy.
4. Do one of the following:
 - On the **Edit** tab, click **Copy**.
 - Right-click and select **Copy**.
5. Pick the origin for the copying.
6. Pick one or more destination points.

If there is an identical physical part at a destination point, Tekla Structures creates an analysis part with settings identical to the original.

If there already was an analysis part at a destination point, Tekla Structures modifies the analysis part.

If a physical part at the destination point is not yet included in the analysis model, Tekla Structures adds the part to the analysis model.

7. To stop copying, do one of the following:
 - Press **Esc**.
 - Right-click and select **Interrupt**.

See also

[Modify analysis parts \(page 65\)](#)

7.7 Delete an analysis part

You can remove parts from analysis models by deleting analysis parts.

If the analysis model content is **Full model** and you delete an analysis part, Tekla Structures ignores the part in the analysis. If the analysis model content is **Selected parts and loads** or **Floor model by selected parts and loads**, and you delete an analysis part, Tekla Structures removes the part from the analysis model.

1. On the **Analysis & design** tab, click **A&D models**.
2. In the **Analysis & Design Models** dialog, select the analysis model that includes the part you want to delete.
3. Select the analysis part to delete.
4. Do one of the following:
 - Right-click and select **Delete**.
 - Press **Delete**.

TIP To undo the **Delete** command:

- For **Full model** analysis models, change the analysis class of the deleted part from **Ignore** to the original setting.
 - For other analysis models, add the deleted part again to the analysis model.
-

See also

[Remove objects from an analysis model \(page 60\)](#)

[Modify analysis models \(page 52\)](#)

[Analysis model content \(page 48\)](#)

8 Combine loads

This section explains the load combination process in Tekla Structures.

Load combination is a process in which some simultaneously acting load groups are multiplied by their partial safety factors and combined with each other according to specific rules.

Load combination rules are specific to a design process and are defined in building or design codes. One of the most typical design processes is the limit state design.

Load combination properties define how Tekla Structures combines loads. The following properties control the load combination process:

- [Load modeling code \(page 112\)](#)
- [Load combination factors \(page 113\)](#)
- [Load combination types \(page 113\)](#)
- [Load group compatibility \(page 20\)](#)

See also

[About load combinations \(page 80\)](#)

[Create load combinations automatically \(page 81\)](#)

[Create a load combination \(page 82\)](#)

[Modify a load combination \(page 83\)](#)

[Copy load combinations between analysis models \(page 83\)](#)

[Delete load combinations \(page 85\)](#)

8.1 About load combinations

A load combination is a set of load groups that is created in the load combination process. Each load combination represents a real loading situation, which means that permanent load should always be included in each load combination.

Each load combination must have a unique name. Use names that describe the loading situation.

Each load combination has an ID. This is an incremental number, based on the order in which load combinations are created in the analysis model.

You can have Tekla Structures automatically create load combinations, or you can create and modify them manually.

See also

[Create load combinations automatically \(page 81\)](#)

[Create a load combination \(page 82\)](#)

[Modify a load combination \(page 83\)](#)

[Copy load combinations between analysis models \(page 83\)](#)

[Delete load combinations \(page 85\)](#)

8.2 Create load combinations automatically

You can have Tekla Structures automatically generate load combinations for an analysis model according to a building code.

Before you start, ensure that you have the appropriate load modeling code selected in **File menu --> Settings --> Options --> Load modeling --> Current code**.

1. On the **Analysis & design** tab, click **A&D models**.
2. In the **Analysis & Design Models** dialog:
 - a. Select an analysis model.
 - b. Click **Load combinations**.
3. In the **Load Combinations** dialog, click **Generate**.
4. In the **Load Combination Generation** dialog:
 - a. If needed, check the load combination factors.
Click **Options**, and then do one of the following:
 - View the factors. Then click **Cancel** to close the dialog.
 - Modify the factors. Then click **OK** to save the changes.
 - b. Select the checkboxes against the combinations you want to create.
 - c. To automatically include the self-weight of parts in load combinations, select the **Include self weight** checkbox.
 - d. (This step only applies to the Eurocode.) If needed, select the **Minimum permanent load with lateral loads only** checkbox. This reduces the amount of load combinations when only minimum

permanent loading needs to be considered in lateral loading situations.

- e. Click **OK** to create the load combinations.

If the analysis model has imperfection loads, Tekla Structures automatically creates load combinations with both the positive and negative directions (x and -x, or y and -y).

5. In the **Load Combinations** dialog, click **OK** to save the load combinations.

See also

[Set the load modeling code \(page 16\)](#)

[Load combination factors \(page 113\)](#)

[Load combination types \(page 113\)](#)

[Create a load combination \(page 82\)](#)

[Modify a load combination \(page 83\)](#)

[Delete load combinations \(page 85\)](#)

8.3 Create a load combination

If needed, you can create load combinations for an analysis model one by one.

Before you start, ensure that you have the appropriate load modeling code selected in **File menu --> Settings --> Options --> Load modeling --> Current code**.

1. On the **Analysis & design** tab, click **A&D models**.
2. In the **Analysis & Design Models** dialog:
 - a. Select an analysis model.
 - b. Click **Load combinations**.
3. In the **Load Combinations** dialog, click **New**.
4. In the **Load Combination** dialog:
 - a. Select a load combination type from the **Type** list.
 - b. Enter a unique name for the load combination.
 - c. Use the arrow buttons to move load groups between the **Load groups** list and the **Load combination** table.
 - d. If needed, modify the signs (+ or -) and combination factors in the **Load combination** table by clicking a value.
 - e. Click **Apply** to create the load combination.
 - f. If needed, repeat steps a–e to create more load combinations.

- g. Click **OK** to create the last load combination and close the dialog.
5. In the **Load Combinations** dialog, click **OK** to save the load combinations.

See also

[Set the load modeling code \(page 16\)](#)

[Load combination types \(page 113\)](#)

[Load combination factors \(page 113\)](#)

[Create load combinations automatically \(page 81\)](#)

[Modify a load combination \(page 83\)](#)

[Delete load combinations \(page 85\)](#)

8.4 Modify a load combination

You can modify the load combinations of an analysis model by changing the load combination name and factors.

You cannot change the load combination type or ID, or add or remove load groups after you have created the load combination.

1. On the **Analysis & design** tab, click **A&D models**.
2. In the **Analysis & Design Models** dialog:
 - a. Select an analysis model.
 - b. Click **Load combinations**.
3. In the **Load Combinations** dialog:
 - a. To change the name of a load combination, select it and enter a new name.
 - b. To change a load combination factor, select it and enter a new value.
 - c. Click **OK** to save the changes.

See also

[Create load combinations automatically \(page 81\)](#)

[Create a load combination \(page 82\)](#)

[Copy load combinations between analysis models \(page 83\)](#)

[Delete load combinations \(page 85\)](#)

8.5 Copy load combinations between analysis models

You can copy load combinations between analysis models within a physical model. You can also copy between physical models if they have the same environment and load groups.

First you need to save the load combinations that you want to copy to a `.lco` file. If you want to make the load combinations available in another physical model, you need to copy the `.lco` file to the `\attributes` folder of the destination model, or to the project or firm folder. Then you can load the load combinations to another analysis model.

Save load combinations for later use

You can save the load combinations of an analysis model for later use in other analysis models.

1. On the **Analysis & design** tab, click **A&D models**.
2. In the **Analysis & Design Models** dialog:
 - a. Select an analysis model.
 - b. Click **Load combinations**.
3. In the **Load Combinations** dialog:
 - a. Enter a name for the saved load combinations in the box next to **Save as**.
 - b. Click **Save as**.

Tekla Structures saves the load combinations as a `.lco` file in the `\attributes` folder under the current model folder.
4. Click **OK** to close the dialogs.

Copy load combinations from another analysis model

You can copy load combinations from another analysis model that has the same load groups and environment.

1. Ensure that the load combinations you want to copy have been saved in a `.lco` file.
2. Check that the `.lco` file is located in the `\attributes` folder under the current model folder, or in the project or firm folder. If not, copy the `.lco` file.
3. If you are copying load combinations between two physical models, open the model to copy to. If you are copying within a physical model, reopen the model.
4. On the **Analysis & design** tab, click **A&D models**.

5. In the **Analysis & Design Models** dialog:
 - a. Select the analysis model to copy to.
 - b. Click **Load combinations**.
6. In the **Load Combinations** dialog:
 - a. Select a load combinations file (.lco) from the list next to **Load**.
 - b. Click **Load**.
7. Click **OK** to close the dialogs.

8.6 Delete load combinations

In Tekla Structures, you can delete load combinations one by one, or several selected or all load combinations of an analysis model at once.

1. On the **Analysis & design** tab, click **A&D models**.
2. In the **Analysis & Design Models** dialog:
 - a. Select the analysis model whose load combinations you want to delete.
 - b. Click **Load combinations**.
3. In the **Load Combinations** dialog, do one of the following:
 - Select the load combination to delete, and then click **Remove**.
 - Hold down the **Ctrl** or **Shift** key and select the load combinations to delete. Then click **Remove**.
 - To delete all load combinations, click **Remove all**.
4. Click **OK** to close the dialogs.

See also

[Modify a load combination \(page 83\)](#)

[Create load combinations automatically \(page 81\)](#)

[Create a load combination \(page 82\)](#)

9 Work with analysis and design models

This section explains how to export, import, merge, and view analysis and design models and how to save and view analysis results.

Click the links below to find out more:

[Check warnings about an analysis model \(page 86\)](#)

[Export a model from Tekla Structures to an analysis application \(page 89\)](#)

[Import changes from Tekla Structural Designer to an analysis model \(page 92\)](#)

[Merge analysis models using analysis applications \(page 96\)](#)

[Save analysis results \(page 98\)](#)

[View the analysis results of a part \(page 99\)](#)

[Show analysis class in model views \(page 100\)](#)

[Show analysis bar, member, and node numbers \(page 100\)](#)

[Show the utilization ratio of parts \(page 101\)](#)

9.1 Check warnings about an analysis model

If there were problems in creating an analysis model, Tekla Structures shows a warning sign in the **Analysis & Design Models** dialog when you select the analysis model.

1. On the **Analysis & design** tab, click **A&D models**.
2. In the **Analysis & Design Models** dialog:
 - a. Select an analysis model.
 - b. If a warning sign appears, click **Display warnings**.

Analysis model name	Analysis application	Analysis model content	Results	Part count	Load count	Warning count
Model 1	Tekla Structural Designer	Full model		23	15	12
Model 2		Selected parts and loads		12	5	3

Tekla Structures displays a warning dialog that lists the problem types that occurred in the analysis model creation. For example:

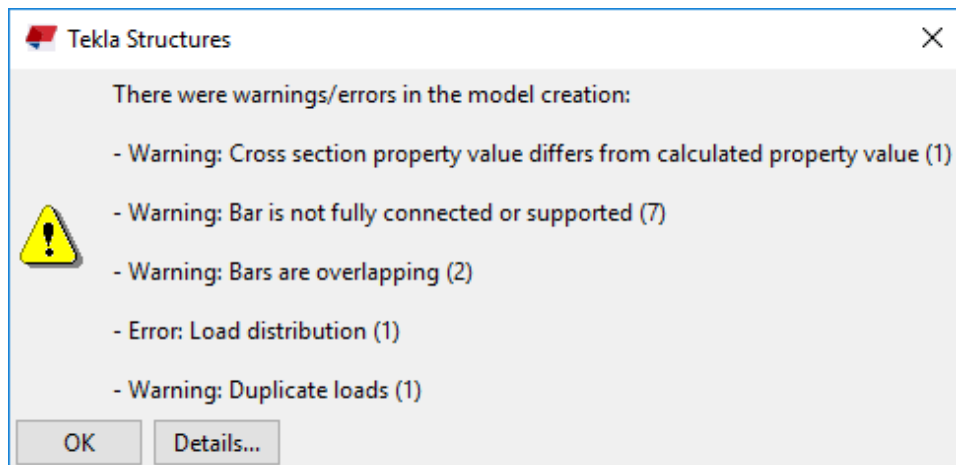

The numbers in the parentheses indicate how many instances of the same problem type there are in the analysis model.

- In the warning dialog, click **Details** to find out more.

Tekla Structures displays a detailed list of warnings and errors. For example:

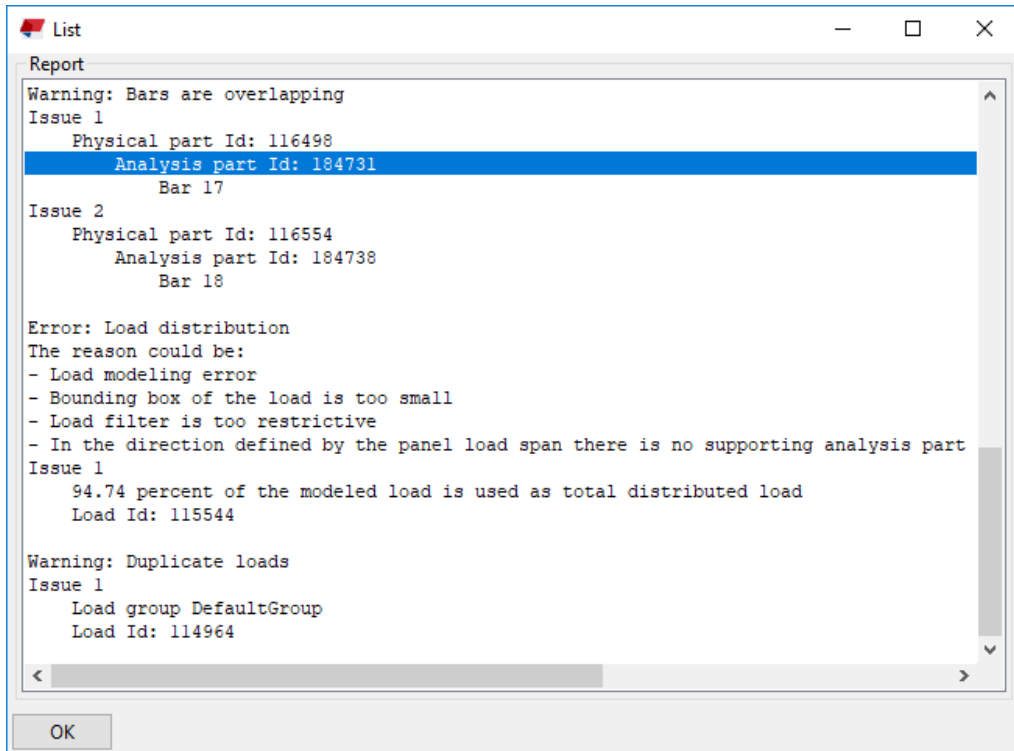

- If you select a row with an object ID, Tekla Structures highlights and selects the corresponding object in the model, such as an analysis part, bar, or node, a load, or a physical part.
Individual analysis members cannot be selected.
- If you right-click a row with an object ID, you can access the object's menu and use commands such as **Inquire** and **Zoom selected**.
- If you select a row with position coordinates, diamond-shaped position locators are displayed in the model to point you to the error.
For example, when a rigid link would be required to connect analysis parts but the rigid links are disabled in the settings, the locators indicate where the rigid link ends should be:



See also

[Create analysis models \(page 47\)](#)

9.2 Export a model from Tekla Structures to an analysis application

To run structural analysis on a Tekla Structures model, you need to export an analysis model or the physical model to an analysis application. For example, you can use Tekla Structural Designer as the analysis application.

Export an analysis model to Tekla Structural Designer

You can export Tekla Structures analysis model data to Tekla Structural Designer along with the physical model. The exported `.cxl` file can be imported to Tekla Structural Designer to update an existing model, or to create a new Tekla Structural Designer model on the basis of the Tekla Structures analysis model.

If you have compatible versions of Tekla Structures and Tekla Structural Designer installed on your computer, also the corresponding Tekla Structural Designer model (`.tsmd` file) can be created or updated during the export, and it then automatically opens in Tekla Structural Designer.

Limitations:

- Walls that consist of several segments are not exported. Only walls with a single analysis area are exported.
- Walls with chamfered corners are exported without chamfers.
- Openings in concrete walls are only exported when the walls and openings are rectangular.
- The physical position of the exported polybeams in Tekla Structural Designer may not match the physical position in Tekla Structures. However, the analysis position is correct.

Before you start:

- Open the Tekla Structures model from which you want to export.
- If you want to manually define which member type will be used for a Tekla Structures part in Tekla Structural Designer, use the **TSD Member Type**, **TSD Slab Type**, or **TSD Wall Type** user-defined attribute of the physical part. These attributes are available on the **Tekla Structural Designer** tab in the part's user-defined attributes dialog in Tekla Structures.

For example, you can set **TSD Slab Type** to `STEEL_DECK_1WAY`, or **TSD Wall Type** to `MID_PIER`.

For more information about the member types, see [Specifying object types in Structural BIM software](#) in the Tekla Structural Designer documentation.

- [Create an analysis model \(page 49\)](#) that includes the parts you want to analyze. Set Tekla Structural Designer as the analysis application in the analysis model properties.
 - Ensure that the analysis parts of the columns are aligned in the analysis model.
1. On the **Analysis & design** tab, click **A&D models**.
Alternatively, you can go to the **File** menu and click **Export --> Tekla Structural Designer with analysis model**.
 2. In the **Analysis & Design Models** dialog:
 - a. Select the analysis model to export.
Ensure that **Analysis application** is set to **Tekla Structural Designer** for this analysis model.
 - b. Click **Export**.
 3. In the **Export to Tekla Structural Designer** dialog:
 - a. Click the **...** button next to **Export file** to set the folder location and name for the export file.

We recommend that you use a file name that indicates the analysis model name, the phase of the analysis and design workflow, and the file transfer direction. For example, `AnalysisModel1 - A - Initial export from TS to TSD` or `AnalysisModel1 - C - Further changes from TS to TSD`.

If you have a compatible version of Tekla Structural Designer installed, the `.tsmd` file type is automatically selected.
 - b. In the **Grids** list, specify which of the Tekla Structures grids you want to export: **All**, **Selected**, or **None**.

With **Selected**, select the grids in the model.
 - c. To check the proposed profile and material grade conversions, open the **Conversions** section and click the preview buttons.

The export uses an internal conversion list containing the standard profiles and material grades. If the profile or material grade of any part cannot be converted using the internal conversion, the export name will be replaced with the following text in the **Conversions** tables:

`--- NO MATCH ---`
 - d. If the text `--- NO MATCH ---` is displayed, or if you want override the standard conversion, you can convert the profiles and materials in the following way:
 - Create a profile and/or material grade conversion file in a text editor using the file name extension `.cnv`.

- In the text file, enter the Tekla Structural Designer profile or material grade name, for profiles the # symbol and the profile code, then the equal sign (=), and the corresponding Tekla Structures name.

You may need help from your local Tekla support with this.

- In the **Profile conversion file** and **Material conversion file** boxes, specify the conversion files that you want to use for mapping profiles and material grades.

If the conversion files are not used, the parts with profiles or material grades that cannot be converted will still be created but they will use the export file profile or material grade that may be invalid.

- e. Click **Export**.

A `.cx1` file is created in the folder you specified using the file name you specified. Also with the `.tsmd` export file type, a `.cx1` is created first and a timestamp is added after the file name.

4. If you have a compatible version of Tekla Structural Designer installed and `.tsmd` selected as the export file type, Tekla Structural Designer starts and the **BIM Integration : Structural BIM Import** wizard appears. Do the following:

- a. Review and modify the settings in the wizard as needed, and then click **Next** in each step.

For example, you can set the building code, and select whether this is a first-time transfer from Tekla Structures to Tekla Structural Designer, or an update to an existing model.

For more information about the options, see 'Import a project from a Structural BIM Import file' in the [Tekla Structural Designer product guides](#).

- b. When you are happy with the settings, click **Finish** in the final step of the wizard.

A Tekla Structural Designer model file (`.tsmd`) is created in the folder you specified using the file name you specified.

Next you can start working with the model in Tekla Structural Designer.

To import a `.cx1` file to Tekla Structural Designer on another computer, for example, see 'Import a project from a Structural BIM Import file' in the [Tekla Structural Designer product guides](#).

Export a physical model to Tekla Structural Designer

If you do not want to create a Tekla Structures analysis model and use it in export to Tekla Structural Designer, you can export a Tekla Structures physical model instead, and use it for analysis in Tekla Structural Designer.

NOTE We recommend that you export to Tekla Structural Designer using the analysis model. It ensures better analytical connectivity and produces a more accurate model in Tekla Structural Designer than the physical model.

For more information about the physical model export, see [Export to Tekla Structural Designer](#) and [Example workflow of integration between Tekla Structures and Tekla Structural Designer](#).

Export an analysis model to an analysis application

To run structural analysis on a Tekla Structures analysis model using an analysis application, you need to export the analysis model into a folder. By default, the export folder is the current model folder. If you have a direct link to an analysis application, and you export an analysis model from Tekla Structures using that particular analysis application, the analysis model is opened in the application.

1. On the **Analysis & design** tab, click **A&D models**.
2. If needed, define the export folder.
 - a. In the **Analysis & Design Models** dialog, select the analysis model to export, and then click **Properties...**
 - b. In the **Analysis Model Properties** dialog, click **Browse for export folder** on the **Analysis model** tab.
 - c. In the **Browse For Folder** dialog, browse to the export folder, and then click **OK**.
 - d. Click **OK** to save the export folder settings with the analysis model properties.
3. In the **Analysis & Design Models** dialog:
 - a. Select the analysis model to export.
 - b. Click **Export**.

9.3 Import changes from Tekla Structural Designer to an analysis model

When you use Tekla Structural Designer as the analysis application, and you have analyzed, designed, and modified a model in Tekla Structural Designer, you can import the changes to Tekla Structures.

You can import the new parts created in Tekla Structural Designer, profile and material changes, design intent reinforcement, and other analysis results.

The location of the existing parts does not change in the Tekla Structures model even if you have moved the corresponding parts in Tekla Structural Designer.

If you want to import reinforcement, you need to have compatible versions of Tekla Structures and Tekla Structural Designer installed on your computer and access to the original Tekla Structural Designer file (.t.smd).

1. Open the Tekla Structures model to which you want to import.
2. On the **Analysis & design** tab, click **A&D models**.
3. In the **Analysis & Design Models** dialog:
 - a. Select the analysis model to which you want to import.
 - b. Click **Get results**.
4. In the **Tekla Structural Designer Import** dialog:
 - a. Click the ... button next to **Import file** to browse for and select the file exported from Tekla Structural Designer.

To import reinforcement, select the original Tekla Structural Designer model file (.t.smd). Rebar sets can be created for pad footings, strip footings, beams, columns, and walls. Meshes are not transferred.
 - b. Select among the following grid options:
 - **Import grids from import file:** The grid lines from the import file will be imported into the Tekla Structures model. A grid line pattern will be created, and all the imported grid lines will be attached as individual grid planes to this pattern.
 - **Delete existing Tekla Structures grids:** Import will remove all grid lines/planes from the current Tekla Structures model.
 - c. If you want to remove slab and wall openings in the Tekla Structures model that were previously imported from Tekla Structural Designer, select the **Remove previously imported openings** checkbox.
 - d. Open the **Location** section and define to which location you want to import the model. Do one of the following:
 - In the **X**, **Y**, and **Z** boxes, enter offsets for the imported model from the global origin of the Tekla Structures model.

- Click **Pick** and then pick a location for the import model datum point in the Tekla Structures model.

You can also define a rotation.

- e. In the **Rebars** section, define whether the reinforcing bars are imported, and how they are imported.

Note that the **Rebars** section and its options will become available only when you have selected a `.tsmd` file as the import file.

- f. To check the proposed profile, material grade, and rebar grade conversions, open the **Conversions** section and click the preview buttons.

The import uses an internal conversion list containing the standard profiles and grades. If the profile or grade of any part cannot be converted using the internal conversion, the Tekla Structures name will be replaced with the following text in the **Conversions** tables:

```
--- NO MATCH ---
```

- g. If the text `--- NO MATCH ---` is displayed, or if you want to override the standard conversion, you can convert the profiles, materials, and rebar grades in the following way:

- Create a profile, material, and/or rebar grade conversion file in a text editor using the file name extension `.cnv`.
- In the text file, enter the Tekla Structural Designer profile, material, or rebar grade name, for profiles the `#` symbol and the profile code, then the equal sign (`=`), and the corresponding Tekla Structures name.

You may need help from your local Tekla support with this.

In the rebar grade conversion file, list the size mappings for the grade on the rows underneath the grade name in the same way, indented by a tab.

```
Gr. 60=A615-60
    TsdSize1=TsSize1
    #3=#14
    #6=#18
TSDgrade=TSGrade
[...]
```

- In the **Profile conversion file**, **Material conversion file**, and/or **Rebar conversion file** boxes, specify the conversion files that you want to use for mapping profiles and grades.

The **Rebar conversion file** box is only available if you have a compatible version of Tekla Structural Designer installed and a `.t.smd` import file selected.

If the conversion files are not used, the parts with profiles or material grades that cannot be converted will still be created but they will use the import file profile or material grade that may be invalid.

- h. Select the **Show model comparison tool** checkbox at the bottom of the dialog.
- i. Click **Import**.

Model Comparison Tool shows all parts that are flagged as **Added**, **Updated**, **Deleted**, or **Unchanged**.

5. In **Model Comparison Tool**, accept or reject changes as follows:
 - a. Go to an appropriate tab: **Added**, **Updated**, **Deleted**, or **Unchanged**.
 - b. To display the properties of an object, select the object from the list on the left.

If the selected object has been updated or deleted, or has not been changed, the object is also highlighted in the model.
 - c. To append the Tekla Structures object ID to the object name in the comparison tool list, select the **Display part IDs** checkbox.
 - d. To reduce the amount of information displayed about the objects that have been updated, select the **Only display changed fields** checkbox.

Only the values that have been changed are displayed instead of all the object properties.
 - e. On the **Added**, **Updated**, and **Deleted** tabs, ensure that the checkbox after the object name is selected for each object (or object type) that you want to import or update.
 - f. On the **Updated** tab, for each object to update, select the object from the list on the left, and then in the list of properties, select the **Apply updates** checkbox for each object property whose value you want to update.
 - g. If you want to exclude the objects that did not previously exist in the Tekla Structures model but that are in the import file, clear the **Add new objects** checkbox.

- h. If you want to delete objects that currently exist in the Tekla Structures model but that are not in the import file, select the **Delete current objects** checkbox.

If you clear this checkbox, no objects will be deleted.

- i. Click **Accept changes** to use the current settings and complete the import.

The result of the import is shown in **Process log** in the **Tekla Structural Designer Import** dialog, for example, the number of parts that have been imported, and any warnings or errors related to the import.

6. Close the **Tekla Structural Designer Import** dialog.

9.4 Merge analysis models using analysis applications

You can merge Tekla Structures analysis models with models in some external analysis applications. This means that you can make changes to Tekla Structures physical and analysis models even after you have exported them to an analysis application, and still keep the additions you have made to the exported models in the analysis application.

For example, you can create a Tekla Structures model, create an analysis model of it, export the analysis model to an analysis application, add special loads to the model in the analysis application, and then run the analysis. If you then need to make changes to the physical or analysis model in Tekla Structures, you can merge models in the analysis application. If you do not merge models and you re-export the changed Tekla Structures analysis model to the analysis application, you will lose the additions you have made to the model in the analysis application.

For more information, see Analysis and design systems.

Merge analysis models using SAP2000

You can merge Tekla Structures analysis models with models in SAP2000.

By default, Tekla Structures and SAP2000 analysis models are not merged. This means that a new SAP2000 model is created always when you export a Tekla Structures analysis model to SAP2000.

If you choose to merge a Tekla Structures analysis model with a model in SAP2000, the changes in the Tekla Structures physical or analysis model are merged to the model in SAP2000. Additional objects and definitions, such as parts, bars, loads, and load combinations, created in SAP2000 are retained in SAP2000. Additional objects created in SAP2000 cannot be imported to Tekla Structures, but they are taken into account in the analysis. They affect the analysis results, which you can import to Tekla Structures.

When exported to SAP2000, the objects created in Tekla Structures will receive a prefix "_" to their names. The prefix distinguishes the objects created in Tekla Structures from the objects created in SAP2000.

Additional loads created in SAP2000 will be added to the load combinations that are created in SAP2000. If you add additional loads to the load combinations that are created in Tekla Structures, the loads will be removed from these load combinations when you merge models and export a Tekla Structures analysis model to SAP2000.

Merging Tekla Structures and SAP2000 analysis models helps in retaining the existing analysis node and bar numbers in SAP2000.

- Existing node numbers are kept if the node coordinates stay the same.
- Existing bar numbers are kept if the start and end node numbers stay the same.
- Old node and bar numbers are not re-used.

Limitations

Changes in the following properties in Tekla Structures are not updated in SAP2000 even if you merge models:

- The profile and material properties of parts if a profile or material name already exists in SAP2000
- Load combinations if the name of the load combination already exists in SAP2000

To keep the changes made in SAP2000 when you re-export a changed Tekla Structures analysis model, you can adjust the profile and material properties and the load combination type in SAP2000.

If you change the support condition settings in SAP2000 and then re-export a Tekla Structures analysis model, you will lose these changes.

How to merge a Tekla Structures analysis model with a model in SAP2000

1. On the **Analysis & design** tab, click **A&D models**.
2. In the **Analysis Model Properties** dialog, do one of the following:
 - To merge an existing analysis model, select the analysis model, and then click **Properties** to check and modify its properties.
 - To create a new analysis model and merge it, click **New**.
3. In the **Analysis Model Properties** dialog:
 - a. In the **Analysis application** list, select **SAP2000**.
 - b. In the **Model merging with analysis application** list, select **Enabled**.

- c. If you are merging a new analysis model, modify the other analysis model properties if needed.
- d. Click **OK** to save the analysis model properties.

Tekla Structures merges the models the next time you export the Tekla Structures analysis model to SAP2000 to run the analysis.

Reset merged analysis models

You can reset model merging between Tekla Structures and external analysis applications.

1. On the **Analysis & design** tab, click **A&D models**.
2. In the **Analysis & Design Models** dialog:
 - a. Select the analysis model to reset.
 - b. Click **Properties**.
3. In the **Analysis Model Properties** dialog:
 - a. In the **Model merging with analysis application** list, select **Disabled**.
 - b. Click **OK** to save the analysis model properties.

9.5 Save analysis results

When you save the analysis results and then save the physical model, Tekla Structures saves the results of all load combinations in a database, `analysis_results.db5`, in the current model folder.

If you do not want to create the analysis results database `analysis_results.db5`, set `XS_AD_RESULT_DATABASE_ENABLED` to `FALSE` in **File menu --> Settings --> Advanced Options --> Analysis & Design** .

Use the following advanced options in **File menu --> Settings --> Advanced Options --> Analysis & Design** to define the analysis member points whose results are saved in the database:

- `XS_AD_MEMBER_RESULT_DIVISION_COUNT`
- `XS_AD_MEMBER_RESULT_DISP_DIVISION_COUNT`
- `XS_AD_MEMBER_RESULT_MIN_DISTANCE`
- `XS_AD_MEMBER_RESULT_GRID_SIZE`

See also

[Save analysis results as user-defined attributes of parts \(page 99\)](#)

Save analysis results as user-defined attributes of parts

After running the analysis, you can save the maximum axial force, shear force, and bending moment at the part ends as user-defined attributes in the part properties. You can save the results for each part in an analysis model or for specific parts.

Before you start, run the analysis.

1. On the **Analysis & design** tab, click **A&D models**.
2. In the **Analysis & Design Models** dialog:
 - a. Select an analysis model.
 - b. Do one of the following:
 - To save the results for each part in the analysis model, click **Get results**.
 - To save the results for specific parts, select the parts in the physical model, and then click **Get results for selected**.

See also

[View the analysis results of a part \(page 99\)](#)

[Show the utilization ratio of parts \(page 101\)](#)

9.6 View the analysis results of a part

You can view a part's analysis results using the user-defined attributes.

Before you start, ensure that you have saved the analysis results using the **Get results** or **Get results for selected** command on the correct analysis model.

1. Double-click a part in the physical model.
2. In the part's property pane, click **User-defined attributes**.
3. In the user-defined attributes dialog:
 - Go to the **End conditions** tab to view the analysis results at the part ends.
 - Go to the **Analysis** tab to view the utilization ratio of a steel part or the required area of reinforcement in a concrete part.

To access the analysis results database, use the .NET interface or Tekla Structures's excel design interface.

See also

[Save analysis results as user-defined attributes of parts \(page 99\)](#)

[Save analysis results \(page 98\)](#)

9.7 Show analysis class in model views

The analysis class defines how Tekla Structures handles individual parts in the analysis. You can show the analysis class of parts in an object group using different colors in the physical model.

Before you start, create an object group that includes the parts whose analysis class you want to show.

1. On the **Analysis & design** tab, click **A&D models**.
2. In the **Analysis & Design Models** dialog, select an analysis model.
3. On the **View** tab, click **Representation**.
4. In the **Object Representation** dialog:
 - a. Select an object group.
 - b. In the **Color** column, select **Color by analysis type** from the list.
 - c. Click **Modify**.

See also

[Analysis class options and colors \(page 132\)](#)

9.8 Show analysis bar, member, and node numbers

You can show the analysis bar, member, and analysis node numbers of the active analysis model in model views.

1. On the **Analysis & design** tab, click **A&D models**.
2. In the **Analysis & Design Models** dialog, select an analysis model.
3. On the **Analysis & design** tab on the ribbon:
 - Click **Member numbers** to switch the analysis member or bar numbers on or off.
 - Click **Node numbers** to switch the analysis node numbers on or off.

Alternatively, you can use the following advanced options in **File menu --> Settings --> Advanced Options --> Analysis & Design** to define which numbers are shown:

- XS_AD_MEMBER_NUMBER_VISUALIZATION
- XS_AD_NODE_NUMBER_VISUALIZATION

- XS_AD_NODE_NUMBER_BY_Z

Some analysis applications work on analysis members whereas others work on analysis bars. This also affects how analysis models are shown in Tekla Structures model views. Either member numbers or bar numbers are shown.

See also

[Analysis model objects \(page 9\)](#)

[Status of analysis nodes \(page 61\)](#)

9.9 Show the utilization ratio of parts

Once you have exported an analysis model to an analysis application and run the analysis, you can view the analysis results. To perform a visual check, you can use different colors to show the utilization ratio of the steel parts in an object group in the physical model.

Before you start, ensure that you have saved the analysis results using the **Get results** or **Get results for selected** command on the correct analysis model.

1. Create an object group that includes the parts whose utilization ratio you want to show.
2. On the **View** tab, click **Representation**.
3. In the **Object Representation** dialog:
 - a. Select the object group whose utilization ratios you want to show.
 - b. In the **Color** column, select **Color by analysis utility check** from the list.
4. In the **Utility Ratio Ranges** dialog:
 - a. Set the ranges of ratio for each of the colors that Tekla Structures uses to show safe and unsafe parts.
 - b. Click **OK**.
5. In the **Object Representation** dialog, click **Modify**.

Tekla Structures shows the utilization ratio of the steel parts in the selected analysis model using the following colors:

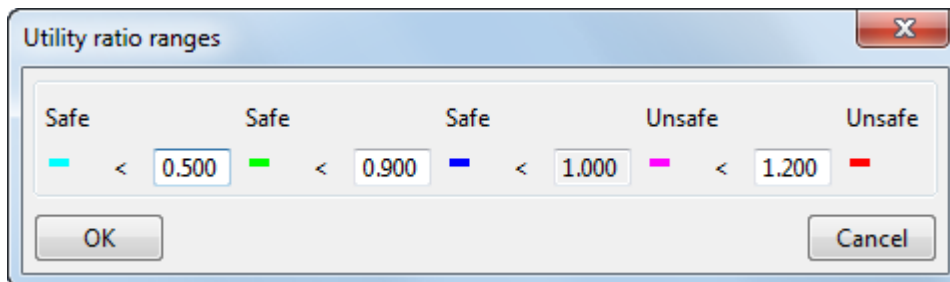

See also

[Save analysis results as user-defined attributes of parts \(page 99\)](#)

[View the analysis results of a part \(page 99\)](#)

10 Analysis and design settings

This section provides information about the various analysis and design settings you can modify in Tekla Structures.

Click the links below to find out more:

[Load group properties \(page 103\)](#)

[Load properties \(page 105\)](#)

[Load combination properties \(page 112\)](#)

[Analysis model properties \(page 115\)](#)

[Analysis part properties \(page 122\)](#)

[Analysis node properties \(page 137\)](#)

[Analysis rigid link properties \(page 138\)](#)

[Analysis bar position properties \(page 140\)](#)

[Analysis area position properties \(page 140\)](#)

[Analysis area edge properties \(page 141\)](#)

10.1 Load group properties

Use the **Load Groups** dialog to view, define, and modify the load group properties and to work with load groups.

Option	Description
Current	<p>The @ character identifies the current load group.</p> <p>When you create loads in the model, Tekla Structures adds them to the current load group. You can only define one load group as current.</p> <p>To change the current load group, select a load group and click Set current.</p>

Option	Description
Name	<p>Unique name of the load group.</p> <p>Use load group names to define the visibility and selectability of loads. For example, you can select, modify, or hide loads based on their load group.</p>
Type	<p>The type of a load group is the type of action that causes the loads.</p> <p>Actions causing loads are building code specific and depend on the load modeling code (page 16) selected in File menu --> Settings --> Options --> Load modeling --> Current code.</p> <p>Most building codes use some or all of the following actions and load group types:</p> <ul style="list-style-type: none"> • Permanent, dead, and/or prestressing loads • Live, imposed, traffic, and/or crane loads • Snow loads • Wind loads • Temperature loads • Accidental and/or earthquake loads • Imperfection loads
Direction	<p>The direction of a load group is the global direction of the action that causes the loads. Individual loads in a load group retain their own magnitudes in the global or local x, y, and z directions.</p> <p>The load group direction affects which loads Tekla Structures combines in a load combination:</p> <ul style="list-style-type: none"> • z direction groups are combined with both x and y direction groups. • x or y direction groups are not combined with each other.
Compatible	<p>A number that identifies all the load groups that are compatible with each other.</p>
Incompatible	<p>A number that identifies all the load groups that are incompatible with each other.</p>
Color	<p>The color that Tekla Structures uses to show the loads in the group.</p>

See also

[Group loads together \(page 18\)](#)

[Work with loads and load groups \(page 41\)](#)

10.2 Load properties

This section provides information about the properties of specific loads.

Use the load properties dialogs to view, define, and modify the load properties. Each load type has its own properties dialog.

Click the links below to find out more:

[Point load properties \(page 105\)](#)

[Line load properties \(page 106\)](#)

[Area load properties \(page 107\)](#)

[Uniform load properties \(page 107\)](#)

[Temperature load properties \(page 108\)](#)

[Wind load properties \(page 109\)](#)

[Load panel settings \(page 110\)](#)

Point load properties

Use the **Point Load Properties** dialog to view and modify the properties of a point load or a bending moment. The file name extension of a point load properties file is `.lml`.

Option	Description
Load group name	The load group to which the load belongs. To view load group properties or to create a new load group, click Load groups .
Magnitude tab	Load magnitudes in the x, y, and z directions of the work plane.
Load attachment	Indicates if the load is attached to a part.
Load-bearing parts	Parts to which the load is applied, or not applied, on the basis of part names or selection filters.
Bounding box of the load	Dimensions of the bounding box in the x, y, and z directions.
Load panel tab	See Load panel settings (page 110) .

See also

[Create a point load \(page 25\)](#)

[Define the properties of a load \(page 22\)](#)

[Load magnitude \(page 23\)](#)

[Attach loads to parts or locations \(page 32\)](#)

[Apply loads to parts \(page 33\)](#)

[Modify the distribution of a load \(page 36\)](#)

Line load properties

Use the **Line Load Properties** dialog to view and modify the properties of a line load or a torsional moment. The file name extension of a line load properties file is `.lm2`.

Option	Description
Load group name	The load group to which the load belongs. To view load group properties or to create a new load group, click Load groups .
Magnitude tab	Load magnitudes in the x, y, and z directions of the work plane.
Load form	Defines how the load magnitude varies along the loaded length.
Load attachment	Indicates if the load is attached to a part.
Load-bearing parts	Parts to which the load is applied, or not applied, on the basis of part names or selection filters.
Bounding box of the load	Dimensions of the bounding box in the x, y, and z directions.
Distances	Offsets from the load end points, used to shorten or lengthen the loaded length. To shorten the loaded length, enter positive values for a and b . To lengthen the loaded length, enter negative values.
Load panel tab	See Load panel settings (page 110) .

See also

[Create a line load \(page 25\)](#)

[Define the properties of a load \(page 22\)](#)

[Load magnitude \(page 23\)](#)

[Load form \(page 24\)](#)

[Distribute and modify loads \(page 32\)](#)

Area load properties

Use the **Area Load Properties** dialog to view and modify the properties of an area load. The file name extension of an area load properties file is `.lm3`.

Option	Description
Load group name	The load group to which the load belongs. To view load group properties or to create a new load group, click Load groups .
Magnitude tab	Load magnitudes in the x, y, and z directions of the work plane.
Load form	Defines the shape of the loaded area.
Load attachment	Indicates if the load is attached to a part.
Load-bearing parts	Parts to which the load is applied, or not applied, on the basis of part names or selection filters.
Bounding box of the load	Dimensions of the bounding box in the x, y, and z directions.
Distances	Offset used to enlarge or reduce the loaded area. To enlarge the loaded area, enter a positive value for a . To reduce the loaded area, enter a negative value.
Load panel tab	See Load panel settings (page 110) .

See also

[Create an area load \(page 26\)](#)

[Define the properties of a load \(page 22\)](#)

[Load magnitude \(page 23\)](#)

[Load form \(page 24\)](#)

[Distribute and modify loads \(page 32\)](#)

Uniform load properties

Use the **Uniform Load Properties** dialog to view and modify the properties of a uniform load. The file name extension of a uniform load properties file is `.lm4`.

Option	Description
Load group name	The load group to which the load belongs. To view load group properties or to create a new load group, click Load groups .

Option	Description
Magnitude tab	Load magnitudes in the x, y, and z directions of the work plane.
Load attachment	Indicates if the load is attached to a part.
Load-bearing parts	Parts to which the load is applied, or not applied, on the basis of part names or selection filters.
Bounding box of the load	Dimensions of the bounding box in the x, y, and z directions.
Distances	Offset used to enlarge or reduce the loaded area.
Load panel tab	See Load panel settings (page 110) .

See also

[Create a uniform load \(page 26\)](#)

[Define the properties of a load \(page 22\)](#)

[Load magnitude \(page 23\)](#)

[Distribute and modify loads \(page 32\)](#)

Temperature load properties

Use the **Temperature Load Properties** dialog to view and modify the properties of a temperature load or a strain. The file name extension of a temperature load properties file is `.1m6`.

Option	Description
Load group name	The load group to which the load belongs. To view load group properties or to create a new load group, click Load groups .
Temperature change for axial elongation	Temperature change in the part.
Temperature differential from side to side	Difference in temperature between the left side and the right side of a part.
Temperature differential from top to bottom	Difference in temperature between the top surface and the bottom surface of a part.
Initial axial elongation	Axial strain of a part. A positive value indicates elongation, a negative value indicates shrinkage.
Load attachment	Indicates if the load is attached to a part.

Option	Description
Load-bearing parts	Parts to which the load is applied, or not applied, on the basis of part names or selection filters.
Bounding box of the load	Dimensions of the bounding box in the x, y, and z directions.

See also

[Create a temperature load or a strain \(page 27\)](#)

[Define the properties of a load \(page 22\)](#)

[Apply loads to parts \(page 33\)](#)

Wind load properties

Use the **Wind Load Generator (28)** dialog to view and modify the properties of wind loads.

To select or modify existing wind loads in the model as a group, use the **Select components** switch .

Option	Description
Wind load direction	The main direction of the wind. The options are: <ul style="list-style-type: none"> • Global X • Global -X • Global Y • Global -Y • Global X, -X, Y, -Y (for all directions)
Nominal wind pressure	The nominal value of wind pressure.
Top level	The highest level of the wind loads.
Bottom level	The lowest level of the wind loads.
Ground level	The level of the ground around the building.
Part names	Parts to which the load is applied, or not applied. See also Define load-bearing parts by name (page 33) .
Front	The external exposure factors for the windward, leeward, and side walls. A positive value indicates pressure, a negative value indicates suction.
Left side	
Back	
Right side	

Option	Description
Internal	The internal exposure factor.
Z profile tab	The distribution of wind load along the height of the building, in terms of pressure factors. Starts from the ground level.
Global X, Global Y, Global -X, Global -Y tabs	<p>A tab for each wind direction, where you can define zones for concentrated corner loads on each wall.</p> <p>Each zone is the height of the wall. Define the width of the zone using either dimensions or proportions. You can define up to five zones for each wall.</p> <p>Walls are numbered according to the order you pick points to indicate the shape of the building on the bottom level.</p>

To select or modify individual existing wind loads in the model as separate

area loads, use the **Select objects in components** switch  and the **Area Load Properties** dialog ([page 107](#)).

See also

[Create wind loads \(page 28\)](#)

[Wind load examples \(page 29\)](#)

Load panel settings

Use the options on the **Load panel** tab in a load properties dialog to modify the way Tekla Structures distributes the load.

Option	Description
Spanning	<p>Defines the directions in which Tekla Structures distributes the load.</p> <ul style="list-style-type: none"> • Single distributes the load only in the direction of the primary axis. • Double distributes the load along the primary and secondary axes.
Primary axis direction	<p>Defines the direction of the primary axis using one of the following methods:</p> <ul style="list-style-type: none"> • A value (1) in the x, y, or z box distributes the load in the corresponding global direction. • Values in multiple boxes distribute the load between the corresponding global directions. The values are the components of the direction vector.

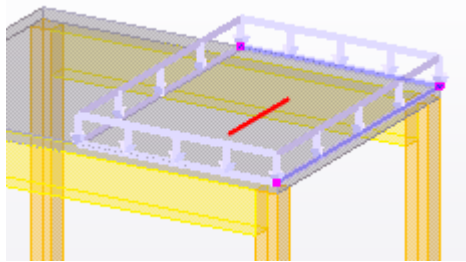
Option	Description
	<ul style="list-style-type: none"> Clicking Parallel to part, or Perpendicular to part, and then selecting a part in the model aligns the primary axis direction with the part. <p>If Spanning is Double, you need to define the primary axis direction to be able to manually define the primary axis weight.</p> <p>To check the primary axis direction of a selected load in a model view, click Show direction on selected loads. Tekla Structures indicates the primary direction using a red line.</p> 
Automatic primary axis weight	<p>Defines whether Tekla Structures automatically weights the directions in load distribution.</p> <p>The options are:</p> <ul style="list-style-type: none"> Yes: Tekla Structures automatically calculates the load portions for the primary and secondary directions in proportion to the third power of the span lengths in these two directions. This means that the shorter the span, the bigger the proportion of the load. No: You can enter the weight for the primary direction in the Weight box. Tekla Structures calculates the weight for the secondary direction by subtracting this value from 1.
Load dispersion angle	<p>The angle by which the load is projected onto the surrounding parts.</p>
Use continuous structure load distribution	<p>Use for uniform loads on continuous slabs. Defines the distribution of support reactions in the first and last spans.</p> <p>The options are:</p>

Option	Description
	<ul style="list-style-type: none"> <li data-bbox="691 277 1390 338">• Yes: The distribution of support reactions is $3/8$ and $5/8$. <div data-bbox="740 367 1406 517" style="text-align: center;"> </div> <ul style="list-style-type: none"> <li data-bbox="691 546 1442 607">• No: The distribution of support reactions is $1/2$ and $1/2$.

See also

[Modify the distribution of a load \(page 36\)](#)

10.3 Load combination properties

This section provides information about the settings that control the load combination process.

Click the links below to find out more:

- [Load modeling code options \(page 112\)](#)
- [Load combination factors \(page 113\)](#)
- [Load combination types \(page 113\)](#)

Load modeling code options

These are the load modeling codes available in Tekla Structures in **File menu** --> **Settings** --> **Options** --> **Load modeling** --> **Current code:**

Option	Description
Eurocode	European code
British	British code
AISC (US)	American Institute of Steel Construction, US code
UBC (US)	Uniform building code, US code
CM66 (F)	French code for steel structures
BAEL91 (F)	French code for concrete structures
IBC (US)	International building code, US code

Option	Description
ACI	American Concrete Institute's publication 318

Each of the available codes has a separate tab in the **Options** dialog. The **Options** dialog lists the partial safety factors in limit states and other combination factors for the code, based on load group types. For the Eurocode, you can also set the reliability class factor and the formula to be used in load combination.

See also

[Set the load modeling code \(page 16\)](#)

[Load combination factors \(page 113\)](#)

Load combination factors

In the load combination process, Tekla Structures uses partial safety factors and, for example, reduction factors on load groups to create load combinations.

The *partial safety factors* needed in the limit state design are:

- Unfavorable partial safety factor in the ultimate limit state (γ_{sup})
- Favorable partial safety factor in the ultimate limit state (γ_{inf})
- Unfavorable partial safety factor in the serviceability limit state (γ_{sup})
- Favorable partial safety factor in the serviceability limit state (γ_{inf})

Depending on the codes you use, you may need to use other combination factors. For example, the Eurocode contains three *reduction factors* (ψ_0, ψ_1, ψ_2). Reduction factors exclude the impractical effects of simultaneous loads.

You can use values for load combination factors that are building code specific or user-defined.

See also

[Set the load modeling code \(page 16\)](#)

[Use non-standard load combination factors \(page 17\)](#)

Load combination types

You can perform several load combination types which vary according to the building code you use.

Use the **Load Combination Generation** dialog, or the **Load Combination** dialog, to select the load combination types you want to create. The options are:

Combination type	Description	Applies to
Ultimate limit state (ULS)	Combines load groups that occur persistently and transiently. Uses the partial safety factors of the ultimate limit state when combining loads.	Eurocode, British, AISC (US)
Serviceability limit state (SLS)	Combines load groups that occur quasi-permanently. Uses the partial safety factors of the serviceability limit state when combining loads.	Eurocode, AISC (US)
Serviceability limit state - Rare (SLS RC)	Combines load groups that occur quasi-permanently and rarely. Uses the partial safety factors of the serviceability limit state when combining loads.	Eurocode
Serviceability limit state - Quasi-permanent (SLS QP)	Combines load groups that occur quasi-permanently. Uses the partial safety factors of the serviceability limit state when combining loads.	Eurocode
Normal loads	Combines load groups and uses factors according to the French codes CM66 or BAEL91.	CM66, BAEL91
Extreme loads		CM66
Displacement loads		CM66
Accidental loads		CM66, Eurocode
Ultimate loads		BAEL91
Ultimate accidental loads		BAEL91
Earthquake loads	Combines load groups and uses factors according to the Eurocode.	Eurocode
Loads for public structures	Combines load groups according to the US IBC code (International Building Code).	IBC (US)
Loads for public structures with drifted snow		IBC (US)
Loads for non public structures		IBC (US)

Combination type	Description	Applies to	
Loads for non public structures with drifted snow		IBC (US)	
Loads for public non concrete and masonry structures	Combines load groups according to the US UBC code (Uniform Building Code).	UBC (US)	
Loads for public non concrete and masonry structures with drifted snow		UBC (US)	
Loads for non concrete and masonry structures		UBC (US)	
Loads for non concrete and masonry structures with drifted snow		UBC (US)	
Loads for public concrete and masonry structures		UBC (US)	
Loads for public concrete and masonry structures with drifted snow		UBC (US)	
Loads for concrete and masonry structures		UBC (US)	
Loads for concrete and masonry structures with drifted snow		UBC (US)	
ACI Table 1 - ACI Table 8		Combines load groups according to the ACI code (American Concrete Institute's publication 318).	ACI

See also

[Combine loads \(page 80\)](#)

10.4 Analysis model properties

Use the **Analysis Model Properties** dialog to define, view, and modify the properties of an analysis model. These properties apply to all parts in an analysis model.

Analysis model tab

Option	Description
Analysis application	<p>The analysis application (page 12) or format used in the analysis of the analysis model.</p> <p>To use the same application or format by default for other new analysis models, select the Set as the default checkbox.</p> <p>See also Link Tekla Structures with an analysis application (page 12).</p>
Analysis model name	<p>A unique name for the analysis model. User-definable.</p> <p>For example, you can use a name that describes the portion of the physical model that you want to analyze.</p> <p>To define the export folder for the analysis model, click Browse for export folder.</p>
Analysis model filter	<p>Defines which objects to include in the analysis model, based on the list of available selection filters.</p> <p>See also Filters in analysis models (page 48).</p>
Bracing member filter	<p>Defines which of the included objects are considered to be braces. The analysis nodes of braces can move more freely than the ones of primary analysis parts when the analysis model is created.</p>
Secondary member filter	<p>Defines which of the included objects are considered to be secondary analysis parts. The nodes of secondary analysis parts can move more freely than the ones of primary analysis parts when the analysis model is created.</p>
Analysis model content	<p>Defines which objects are included in the analysis model.</p> <p>The options are:</p> <ul style="list-style-type: none"> • Selected parts and loads <p>Only includes selected parts and loads, and parts created by components, when they match the analysis model filter.</p> <p>To later add or remove parts and loads, use the Add selected objects or Remove selected objects button in the Analysis & Design Models dialog.</p> • Full model <p>Includes all main parts and loads, except for parts whose analysis class (page 132) is ignore. Tekla</p>

Option	Description
	<p>Structures automatically adds physical objects to the analysis model when they are created and when they match the analysis model filter.</p> <ul style="list-style-type: none"> • Floor model by selected parts and loads <p>Only includes selected columns, slabs, floor beams, and loads when they match the analysis model filter. Tekla Structures replaces columns in the physical model with supports.</p> <p>See also Analysis model content (page 48).</p>
Use rigid links	<p>Use to allow or prevent rigid links in the analysis model.</p> <p>The options are:</p> <ul style="list-style-type: none"> • Enabled <p>Rigid links are created if they are needed to connect analysis parts.</p> <ul style="list-style-type: none"> • Disabled, with keep axis: Default <p>No rigid links are created. The Keep axis position settings of the analysis parts are not changed.</p> <ul style="list-style-type: none"> • Disabled, with keep axis: No <p>No rigid links are created. The Keep axis position settings of the connected analysis parts are changed to No.</p> <p>If you use Tekla Structural Designer as the analysis application, you can use the Enabled option for concrete parts. The Disabled, with keep axis: Default option is automatically used for steel parts.</p>
Analysis model rules	<p>Click to create rules to define how Tekla Structures handles individual parts in the analysis model, and how parts are connected with each other in the analysis.</p>
Curved beams	<p>Defines whether beams are analyzed as curved beam or as straight segments. Select either:</p> <ul style="list-style-type: none"> • Split into straight segments • Use curved member <p>Use the advanced option XS_AD_CURVED_BEAM_SPLIT_ACCURACY_MM in File menu --> Settings --> Advanced Options --> Analysis & Design to define how closely straight segments follow the curved beam.</p>

Option	Description
Consider twin profiles	Defines whether twin profiles are considered as one part (Enabled) or as two parts (Disabled) in the analysis.
Member axis location	<p>Defines the location of each analysis part in relation to the corresponding physical part.</p> <p>The options are:</p> <ul style="list-style-type: none"> • Neutral axis The neutral axis is the analysis axis for all parts. The location of the analysis axis changes if the profile of the part changes. • Reference axis (eccentricity by neutral axis) The part reference line is the analysis axis for all parts. The location of the neutral axis defines axis eccentricity. • Reference axis The part reference line is the analysis axis for all parts. • Model default The analysis axis of each part is defined individually according to the analysis part properties. To define the axis location of specific parts, use the Position tab in the appropriate analysis part properties dialog. <p>If you select Neutral axis, Tekla Structures takes the part location and end offsets into account when it creates nodes. If you select either of the Reference axis options, Tekla Structures creates nodes at part reference points.</p>
Member end release method by connection	Defines whether the support conditions of parts (No) or connections (Yes) are used.
Automatic update	<p>Defines if the analysis model is updated according to the changes in the physical model.</p> <p>The options are:</p> <ul style="list-style-type: none"> • Yes - Physical model changes are considered • No - Physical model changes are ignored

Option	Description
Model merging with analysis application	<p>Only use with SAP2000 when changes occur in the Tekla Structures physical or analysis model that has already been exported to the analysis application.</p> <p>Defines whether the changed analysis model is merged with the previously exported model in the analysis application.</p> <p>The options are:</p> <ul style="list-style-type: none"> • Disabled Models are not merged. Additions made in the analysis application to the previously exported model are lost. A new model is created every time you export the analysis model to the analysis application. • Enabled Models are merged. Additions made in the analysis application to the previously exported model are retained when you re-export the analysis model to the analysis application. The model in the analysis application is updated with the changes from Tekla Structures.

Analysis tab

Option	Description
Analysis method	<p>Defines whether second order stresses are taken into consideration.</p> <p>The options are:</p> <ul style="list-style-type: none"> • 1st order Linear analysis method. • P-Delta A simplified second order analysis method. This method gives accurate results when deflections are small. • Non-linear Non-linear analysis method.
Maximum number of iterations	Tekla Structures repeats second order iteration until it reaches one of these values.
Accuracy of the iteration	

Option	Description
Modal analysis model	Select Yes to create a modal analysis model and to use modal analysis properties instead of static load combinations.

Job tab

Defines the job information in STAAD.Pro reports.

Output tab

Defines the contents of the STAAD.Pro analysis results file.

Seismic tab

Use the **Seismic** tab to define which building code to follow in the seismic analysis and the properties required by the seismic analysis. These properties vary depending on the code you select.

Option	Description
Type	The building code to use to generate seismic loads. The options are: <ul style="list-style-type: none"> • None: Seismic analysis not run. • UBC 1997: Uniform Building Code 1997 • UBC 1994: Uniform Building Code 1994 • IBC 2000: International Building Code 2000 • IS 1893-2002: Indian Standard. Criteria for Earthquake Resistant Design of Structures • IBC 2003: International Building Code 2003 • IBC 2006: International Building Code 2006 • IBC 2006 (ZIP): International Building Code 2006, with an option to add a ZIP code in the properties • IBC 2006 (Longitude/Latitude): International Building Code 2006, with an option to add longitude and latitude information in the properties • AIJ: Japanese code • Response spectrum: Response spectrum specification
Seismic properties	Depending on the code you select, you can define various seismic properties.

Seismic masses tab

The loads and load groups included in the seismic analysis.

Modal analysis tab

Use the **Modal analysis** tab to define the properties required by the modal analysis.

Option	Description
Count of modes	The number of natural mode shapes in the structure.
Max frequency	The maximum natural resonant frequency of the structure.
Modal analysis masses	The loads and load groups included in the modal analysis.

Design tabs

Use the **Design** tabs for steel, concrete, and timber to define the codes and methods to use in structural design. The design options available vary depending on the material.

Option	Description
Design code	Design codes for different materials. The design code options available vary depending on the analysis application you use.
Design method	The material-specific principle used to compare stresses and material capacities. The options are: <ul style="list-style-type: none">• None Tekla Structures only runs a structural analysis and creates data on stresses, forces, and displacements. Available for steel, concrete, and timber.• Check design Tekla Structures checks whether the structures fulfill the criteria in the design code (whether cross sections are adequate). Available for steel and timber.• Calculate required area Tekla Structures defines the required area of reinforcement. Available for concrete.

Option	Description
Design properties	<p>The design code and method specific design properties of the analysis model that apply to all parts in the analysis model.</p> <p>When you select a design code and method for a material, Tekla Structures lists the design properties in the lower part of the Design tab.</p> <p>To change the value of a particular property, click on an entry in the Value column.</p> <p>The units depend on the settings in File menu --> Settings --> Options --> Units and decimals.</p> <p>To change the design properties of a specific part, use the Design tab in the appropriate analysis part properties dialog.</p>

See also

[Create analysis models \(page 47\)](#)

[Modify the properties of an analysis model \(page 53\)](#)

10.5 Analysis part properties

Use the options in a part's analysis properties dialog (for example, **Beam Analysis Properties**) to define how Tekla Structures handles the part in the analysis. The settings you have available in the dialog vary depending on the part type and analysis class. The table below lists all settings regardless of the part type and the analysis class.

Analysis tab

Use the **Analysis** tab to define the analysis properties of a part.



Option	Description
Class	<p>Defines how the part is handled in the analysis.</p> <p>The selected Class defines which analysis properties are available. For example, plates have different properties from columns.</p>
Filter (Rigid diaphragm properties)	<p>Only available when the Class is Contour plate - Rigid diaphragm or Slab - Rigid diaphragm.</p> <p>Defines the filter used when filtering objects for a rigid diaphragm.</p> <p>Nodes that belong to a part matching the filter will be connected to the rigid diaphragm. For example, you</p>

Option	Description
	can use a column filter to connect only column nodes to rigid diaphragms.
Built-up section mode	<p>Indicates the role of the part in a built-up section that consists of a main part and one or more sub-parts. In the analysis, sub-parts are merged to the main part.</p> <p>The options are:</p> <ul style="list-style-type: none"> • Automatic • Not part of built-up section Disconnects the part from a built-up section. • Main part of built-up section Always use to define the main part of a built-up section. • Sub-part of built-up section • Beam sub-part of built-up section Defines that the part is a part of the built-up section when the main part of the built-up section is a beam. • Column sub-part of built-up section Defines that the part is a part of the built-up section when the main part of the built-up section is a column.
Design group	Defines to which design group the part belongs. Used in optimization.
Automatic update	<p>Defines if the analysis part is updated according to the changes in the physical model.</p> <p>The options are:</p> <ul style="list-style-type: none"> • Yes - Physical model changes are considered • No - Physical model changes are ignored

Start releases tab, End releases tab

Use the **Start releases** and **End releases** tabs to define the support conditions and the degrees of freedom for the part ends.

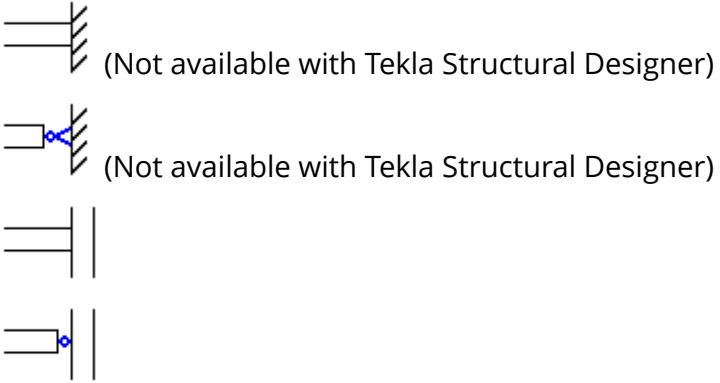
The **Start releases** tab relates to the first part end (yellow handle), the **End releases** tab to the second part end (magenta handle).

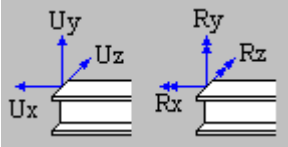
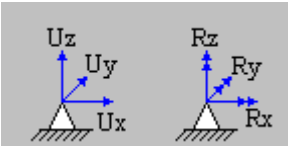
Option	Description
<p>Start or End</p>	<p>Defines which of the predefined or user-defined combinations for end conditions is used for part start or end.</p> <p>These are the predefined options:</p>  <p>(Not available with Tekla Structural Designer)</p> <p>(Not available with Tekla Structural Designer)</p> <p>They automatically set the support condition and degrees of freedom.</p> <p>You can modify a predefined combination to suit your needs. If you do that, Tekla Structures indicates it with this option:</p> 
<p>Support condition</p>	<p>Not available with Tekla Structural Designer.</p> <p>Defines the support condition.</p> <p>The options are:</p> <ul style="list-style-type: none"> <p>Connected</p>  <p>Part end is connected to an intermediate analysis node (another part).</p> <p>Indicate degrees of freedom for the node.</p> <p>Supported</p> 

Option	Description
	<p>Part end is the ultimate support for a superstructure (for example, the foot of a column in a frame).</p> <p>Indicate degrees of freedom for the support.</p>
Rotation	<p>Only available if Support condition is Supported.</p> <p>Defines whether the support is rotated.</p> <p>The options are:</p> <ul style="list-style-type: none"> • Not rotated • Rotated <p>If you select Rotated, you can define the rotation around the local x or y axis, or you can set the rotation by the current work plane by clicking Set rotation by current work plane.</p>
Ux Uy Uz	<p>Define the translational degrees of freedom (displacements) in the global x, y, and z directions.</p> <p>The options are:</p> <ul style="list-style-type: none"> • Free • Fixed • Spring <p>If you select Spring, enter the translational spring constant. The units depend on the settings in File menu --> Settings --> Options --> Units and decimals.</p>
Rx Ry Rz	<p>Define the rotational degrees of freedom (rotations) in the global x, y, and z directions.</p> <p>The options are:</p> <ul style="list-style-type: none"> • Pinned • Fixed • Spring • Partial release <p>If you select Spring, enter the rotational spring constant. The units depend on the settings in File menu --> Settings --> Options --> Units and decimals.</p> <p>Use Partial release to specify if the degree of connectivity is between fixed and pinned. Enter a value between 0 (fixed) and 1 (pinned).</p>

Composite tab

Use the **Composite** tab with STAAD.Pro to define the analysis properties of the slab in a composite beam.

Option	Description
Composite beam	Defines whether the composition is a: <ul style="list-style-type: none">• Non-composite beam• Composite beam• Automatic composite beam
Material	Defines the material of the slab.
Thickness	Defines the thickness of the slab.
Effective slab width	Defines if the effective slab width is calculated automatically or based on the values you enter. You can define different values for the left and right side of the beam. Automatic values are calculated in relation to the span length.

Spanning tab

Use the **Spanning** tab to define the analysis and load distribution properties of a one-way or two-way slab system.

Option	Description
Spanning	Defines in which directions the part carries loads. The options are: <ul style="list-style-type: none">• Single spanning plate carries loads in the direction of the primary axis. Beams or columns parallel to the spanning direction are not connected to the part, and will not carry loads from the part.• Double spanning part carries loads along the primary and secondary axes. Beams or columns in both directions will carry loads from the part.
Primary axis direction	Defines the direction of the primary axis in one of the following ways: <ul style="list-style-type: none">• Enter 1 in the box (x, y, or z) which is parallel to the primary axis direction.• Enter values in multiple boxes to define the components of a direction vector.• Click Parallel to part, and then select a part in the model that is parallel to the direction.

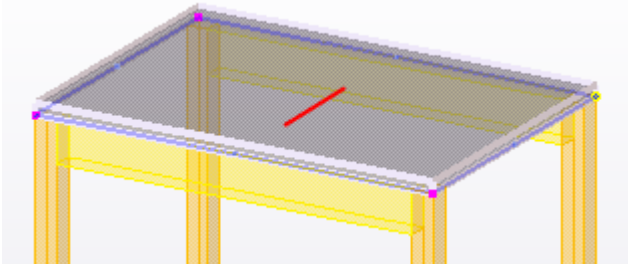
Option	Description
	<ul style="list-style-type: none"> Click Perpendicular to part, and then select a part in the model that is perpendicular to the direction. <p>To check the primary spanning direction of a selected part in a model view, click Show direction on selected members. Tekla Structures indicates the primary direction using a red line.</p> 

Loading tab

Use the **Loading** tab to include a part as loads in analysis models.

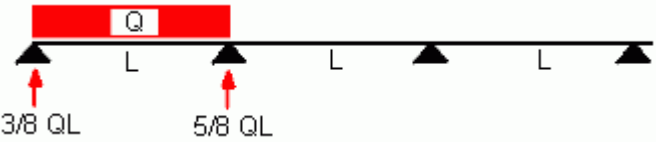
Option	Description
Generate self weight load	<p>Analysis models include the part weight, for example a deck, as a load even if the part is not otherwise included in the analysis models.</p> <p>If the part is included in an analysis model, so is its self-weight. The option No works only with the analysis classes Ignore and Rigid diaphragm.</p>
List boxes for additional loads	Enter slab live load or additional self-weight (screed, services) using three additional loads with a load group name and magnitude. The directions of these loads follow the direction of the load group to which they belong.
Part names	Use this filter to ensure that the area load from the slab is transferred to the correct parts, for example, beams supporting the slab. Typically, you would enter the beam name as the filter value.
Use continuous structure load distribution	Use to assign most of the load to the middle supports on continuous structures. 

Design tab

Use the **Design** tab in the analysis part properties dialog to view and modify the design properties of an individual part in an analysis model. Design properties are properties which can vary, according to the design code and the material of the part (for example, design settings, factors, and limits).

Position tab

Use the **Position** tab to define the location and offsets of an analysis part.

Option	Description
Axis	<p>Defines the location of the analysis part in relation to the corresponding physical part.</p> <p>The location of the analysis axis of a part defines where the part meets with other parts and where Tekla Structures creates nodes in analysis models.</p> <p>The options are:</p> <ul style="list-style-type: none">Neutral axisReference axis (eccentricity by neutral axis)Reference axisTop leftTop centerTop rightMiddle leftMiddle centerMiddle rightBottom leftBottom centerBottom rightTop planeMiddle planeBottom planeLeft planeRight planeMiddle plane (of left/right) <p>If you select Neutral axis, Tekla Structures takes the part location and end offsets into account when it creates nodes. If you select either of the Reference axis options, Tekla Structures creates nodes at part reference points.</p>
Keep axis position	<p>Defines whether the axis position is kept or changed according to changes in the physical model.</p> <p>The options are:</p>

Option	Description
	<ul style="list-style-type: none"> <li data-bbox="691 271 1444 427">• No The axis is free to move when snapping end positions to nearby objects. Use this option for secondary members. <li data-bbox="691 439 1444 595">• Partial - keep in major direction The axis is free to move partially, but the member is not moved in the major (stronger) direction of the part profile. <li data-bbox="691 607 1444 763">• Partial - keep in minor direction The axis is free to move partially, but the member is not moved in the minor (weaker) direction of the part profile. <li data-bbox="691 775 1444 931">• Yes The axis is not moved, but the end positions can move along the axis (thus extending or shortening the member). <li data-bbox="691 943 1444 1077">• Yes - Keep end positions also The axis and the end positions of the member are not changed.
Connectivity	<p data-bbox="691 1077 1444 1155">Defines whether the member snaps or connects with rigid links to other members.</p> <p data-bbox="691 1167 1444 1200">The options are:</p> <ul style="list-style-type: none"> <li data-bbox="691 1211 1444 1335">• Automatic The member snaps or connects with rigid links to other members. <li data-bbox="691 1346 1444 1547">• Manual The member does not snap or connect with rigid links to other members. Automatic connectivity to other members is created only if the member position matches the other member exactly.
Axis modifier X Axis modifier Y Axis modifier Z	<p data-bbox="691 1547 1444 1626">Define whether the member location is bound to global coordinates, grid line, or neither.</p> <p data-bbox="691 1637 1444 1671">The options are:</p> <ul style="list-style-type: none"> <li data-bbox="691 1682 1444 1783">• None The member location is not bound. <li data-bbox="691 1794 1444 1906">• Fixed coordinate The member location is bound to the coordinate you enter in the X, Y, or Z box.

Option	Description
	<ul style="list-style-type: none"> • Nearest grid The member is bound to the nearest grid line (the snap zone is 1000 mm).
Offset	Use to move the analysis part in the global x, y, and z directions.
Longitudinal offset mode	<p>Defines whether the longitudinal end offsets Dx of the physical part are used from the physical part properties.</p> <p>The options are:</p> <ul style="list-style-type: none"> • Offsets are not considered • Only extensions are considered • Offsets are always considered

Bar attributes tab

Use the **Bar attributes** tab in a frame object's (beam, column, or brace) analysis properties dialog to define the properties of its analysis bars.

You can use the options on this tab when the analysis class of the analysis part is **Beam**, **Column**, or **Secondary**.

Option	Description
Start offset End offset	<p>Calculate offsets to account for longitudinal eccentricity at the member end (resulting in a bending moment).</p> <p>These offsets have no effect on the topology on the analysis model. The offset value is only passed as a member attribute to the analysis.</p>
Replacement profile name	<p>Select a profile from the profile catalog. You can use different analysis profiles at the start and end of parts if the analysis application you use supports it.</p> <p>To use different profiles at part ends, enter two profiles separated by a pipe character, for example: HEA120 HEA140</p> <p>If the part is a built-up section in an analysis model, the name of the built-up section can be entered here. Any name can be entered, but if the name matches an existing catalog profile name, the physical properties of the section will be the same as the catalog profile properties.</p>
Curved beam mode	<p>Defines whether a beam is analyzed as a curved beam or as straight segments.</p> <p>The options are:</p>

Option	Description
	<ul style="list-style-type: none"> • Use model default • Use curved member • Split into straight segments <p>If you select Use model default, Tekla Structures uses the option selected from the Curved beams list in the Analysis Model Properties dialog.</p> <p>Use the advanced option XS_AD_CURVED_BEAM_SPLIT_ACCURACY_MM in File menu --> Settings --> Advanced Options --> Analysis & Design to define how closely straight segments follow the curved beam.</p>
No. of split nodes	<p>Use to create additional nodes or analyze a beam as straight segments, for example, a curved beam.</p> <p>Enter the number of nodes.</p>
Split distances	<p>To define additional nodes in the member, enter distances from the part starting point to the node.</p> <p>Enter distances, separated by spaces, for example: 1000 1500 3000</p>
Bar start number	Defines the start number for analysis bars.
Member start number	Defines the start number for analysis members.

Area attributes tab

Use the **Area attributes** tab in a plate's (contour plate, concrete slab, or concrete panel) analysis properties dialog to define the properties of its analysis elements.

You can use the options on this tab when the analysis class of the analysis part is **Contour plate**, **Slab**, or **Wall**.

Option	Description
Element type	The shape of the elements.
Rotation of local XY	Defines the rotation of the local xy plane.
Element size	<p>x and y: The approximate dimensions of the elements, in the local x and y direction of the plate. For triangular elements, the approximate dimensions of the bounding box around each element.</p> <p>Holes: The approximate size of the elements around openings.</p>
Area start number	Defines the start number for the plate.
Simple area (ignore cuts etc)	Select Yes to create a simpler analysis model of the plate, where cuts and openings are not considered.

Option	Description
Smallest hole size to consider	<p>Use to ignore small openings in the plate in the analysis.</p> <p>Enter the size of the bounding box around the opening.</p>
Supported	<p>Not available with Tekla Structural Designer.</p> <p>Use to define supports for a contour plate, concrete slab, or concrete panel.</p> <p>You can create supports for the bottom edge of a panel, for all edge nodes of a slab or plate, or for all nodes of a beam. For panels, the bottom edge can be inclined.</p> <p>The options are:</p> <ul style="list-style-type: none"> • No No supports are created. • Simply (translations) Only translations are fixed. • Fully Both translations and rotations are fixed.

See also

[Analysis class options and colors \(page 132\)](#)

[Analysis axis options \(page 135\)](#)

[Modify the properties of an analysis part \(page 66\)](#)

[Define end releases and support conditions \(page 68\)](#)

[Define design properties for analysis parts \(page 71\)](#)

[Define the location of analysis parts \(page 75\)](#)

Analysis class options and colors

Use the options in the **Class** list on the **Analysis** tab in a part's analysis properties dialog to define how Tekla Structures handles the part in the analysis.

The option you select in the **Class** list determines which tabs are available in the [analysis part properties \(page 122\)](#) dialog.

When the advanced option `XS_AD_MEMBER_TYPE_VISUALIZATION` is set to `TRUE` (which is the default value), you can show the analysis class of parts

using the following colors in the analysis model. You can also indicate the analysis classes using different colors in the [physical model \(page 100\)](#).

The analysis application you use may not support all of the following options. For example, the **Truss** options are not available with Tekla Structural Designer.

Option	Description	Color
Beam	Line object of two nodes. Part can take any load, including temperature.	Blue
Beam - Truss	Part can only take axial forces, not bending or torsion moments, or shear forces.	Bright green
Beam - Truss-Compression only	Part can only take compressive axial forces, not moments or shear forces. If this part goes into tension, it is ignored in the analysis.	Yellow
Beam - Truss-Tension only	Part can only take tensile axial forces, not moments or shear forces. If this part goes into compression, it is ignored in the analysis.	Pink
Beam - Ignore	Part is ignored in the analysis. Self-weight load is taken into account if you have set Generate self weight load to Yes on the Loading tab.	Part not shown in the model
Column	Vertical line object of two nodes. Modeled from bottom to top. Part can take any load, including temperature.	Blue
Column - Truss	Part can only take axial forces, not bending or torsion moments, or shear forces.	Bright green
Column - Truss-Compression only	Part can only take compressive axial forces, not moments or shear forces. If this part goes into tension, it is ignored in the analysis.	Yellow
Column - Truss-Tension only	Part can only take tensile axial forces, not moments or shear forces. If this part goes into compression, it is ignored in the analysis.	Pink
Column - Ignore	Part is ignored in the analysis. Self-weight load is taken into account if you have set Generate self weight load to Yes on the Loading tab.	Part not shown in the model
Bracing	Line object of two nodes. Part can take any load, including temperature. For parts whose analysis class is Bracing, Keep axis position is off by default.	Green
Bracing - Truss	Part can only take axial forces, not bending or torsion moments, or shear forces.	Bright green

Option	Description	Color
Bracing - Truss-Compression only	Part can only take compressive axial forces, not moments or shear forces. If this part goes into tension, it is ignored in the analysis.	Yellow
Bracing - Truss-Tension only	Part can only take tensile axial forces, not moments or shear forces. If this part goes into compression, it is ignored in the analysis.	Pink
Bracing - Ignore	Part is ignored in the analysis. Self-weight load is taken into account if you have set Generate self weight load to Yes on the Loading tab.	Part not shown in the model
Secondary	Line object of two nodes. Part can take any load, including temperature. For parts whose analysis class is Secondary , Keep axis position is off by default. Secondary parts snap to nearest nodes instead of part end nodes.	Orange
Secondary - Ignore	Part is ignored in the analysis. Self-weight load is taken into account if you have set Generate self weight load to Yes on the Loading tab.	Part not shown in the model
Wall - Shell	Part can take any load, except temperature.	Aqua
Wall - Plate	Same as Wall - Shell but plate elements are used in the analysis application.	Aqua
Wall - Shear wall	Part can take lateral forces and vertical forces.	Aqua
Wall - Ignore	Part is ignored in the analysis. Self-weight load is taken into account if you have set Generate self weight load to Yes on the Loading tab.	Aqua
Slab - Shell	Part can take any load, except temperature.	Aqua
Slab - Plate	Same as Slab - Shell but plate, membrane, or mat foundation elements are used in the analysis application.	Aqua
Slab - Membrane		
Slab - Mat foundation		
Slab - Rigid diaphragm	Only applies to parts parallel to a global xy plane. Filter: Nodes that belong to a part matching the filter will be connected with rigid links which together affect displacement. For example, you can use a column filter to connect only column nodes to rigid diaphragms.	Lilac

Option	Description	Color
Slab - Ignore	Part is ignored in the analysis. Self-weight load is taken into account if you have set Generate self weight load to Yes on the Loading tab.	Part not shown in the model
Contour plate - Shell	Part can take any load, except temperature.	Aqua
Contour plate - Plate	Same as Contour plate - Shell but plate or membrane elements are used in the analysis application.	Aqua
Contour plate - Membrane		Aqua
Contour plate - Rigid diaphragm	Only applies to parts parallel to a global xy plane. Filter: Nodes that belong to a part matching the filter will be connected with rigid links which together affect displacement. For example, you can use a column filter to connect only column nodes to rigid diaphragms.	Lilac
Contour plate - Ignore	Part is ignored in the analysis. Self-weight load is taken into account if you have set Generate self weight load to Yes on the Loading tab.	Part not shown in the model

Analysis axis options

Use the options in the **Axis** list on the **Position** tab in a part's analysis properties dialog to define the location of the analysis part in relation to the physical part.

Option	Description	Use for
Neutral axis	The neutral axis is the analysis axis for this part. The location of the analysis axis changes if the profile of the part changes.	
Reference axis (eccentricity by neutral axis)	The part reference line is the analysis axis for this part. The location of the neutral axis defines the axis eccentricity.	
Reference axis	The part reference line is the analysis axis for this part.	
Top left	The analysis axis is located in the top left corner of the part.	Beam objects (beams,

Option	Description	Use for
		columns, braces)
Top center	The analysis axis is located in the top center point of the part cross section.	Beam objects
Top right	The analysis axis is located in the top right corner of the part.	Beam objects
Middle left	The analysis axis is located in the middle of the left side of the part.	Beam objects
Middle center	The analysis axis is located in the center point of the part cross section.	Beam objects
Middle right	The analysis axis is located in the middle of the right side of the part.	Beam objects
Bottom left	The analysis axis is located in the bottom left corner of the part.	Beam objects
Bottom center	The analysis axis is located in the bottom center point of the part cross section.	Beam objects
Bottom right	The analysis axis is located in the bottom right corner of the part.	Beam objects
Top plane	The analysis axis is bound to the top plane.	Plate objects (plates, slabs, panels)
Middle plane	The analysis axis is bound to the middle plane.	Plate objects
Bottom plane	The analysis axis is bound to the bottom plane.	Plate objects
Left plane	The analysis axis is bound to the left plane.	Plate objects
Right plane	The analysis axis is bound to the right plane.	Plate objects
Middle plane (of left/right)	The analysis axis is bound to the middle plane of left/right.	Plate objects

Tekla Structures uses the options above for each part when you select **Model default** from the **Member axis location** list in the **Analysis Model Properties** dialog.

If you select **Neutral axis**, Tekla Structures takes the part location and end offsets into account when it creates nodes. If you select either of the **Reference axis** options, Tekla Structures creates nodes at part reference points.

TIP You can also use keyboard shortcuts to move the selected analysis part in relation to the physical part.

See also

[Analysis part properties \(page 122\)](#)

[Analysis model properties \(page 115\)](#)

[Define or modify the axis location of an analysis part \(page 76\)](#)

10.6 Analysis node properties

Use the **Analysis node properties** dialog to view and modify the properties of a node in an analysis model.

To access the dialog, double-click an analysis node.

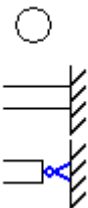
Option	Description
Supports	<p>Defines which support conditions are used for the node.</p> <p>The options are:</p> <ul style="list-style-type: none">• Get supports from part(s) The support conditions of a corresponding part end are used for the node.• User-defined node supports You can define the support conditions for the node. <p>If you select User-defined node supports, you can select one of the following options:</p>  <p>These options automatically set the degrees of freedom for the node.</p> <p>You can modify a predefined combination to suit your needs. If you do that, Tekla Structures indicates it with this option:</p>

Option	Description
	
Rotation	<p>If you selected User-defined node supports, you can define the rotation of the node.</p> <p>The options are:</p> <ul style="list-style-type: none"> • Not rotated • Rotated <p>If you select Rotated, you can define the rotation, or you can set the rotation by the current work plane by clicking Set rotation by current work plane.</p>
Ux Uy Uz Rx Ry Rz	<p>Define the translational (U) and rotational (R) degrees of freedom (displacements and rotations) of the node in the global x, y, and z directions.</p> <p>The options are:</p> <ul style="list-style-type: none"> • Free • Fixed • Spring <p>If you select Spring, enter the spring constant. The units depend on the settings in File menu --> Settings --> Options --> Units and decimals.</p>

See also

[Create an analysis node \(page 61\)](#)

[Merge analysis nodes \(page 63\)](#)

[Analysis model objects \(page 9\)](#)



[Status of analysis nodes \(page 61\)](#)

10.7 Analysis rigid link properties

Use the **Analysis rigid link properties** dialog to view and modify the end conditions of a rigid link.

To access the dialog, double-click a rigid link.

Option	Description
Releases	<p>Defines which releases are used for a rigid link start or end.</p> <p>The options are:</p>

Option	Description
	<ul style="list-style-type: none"> • Automatic releases (by rules) • User-defined releases
<p>Start or End</p>	<p>Defines which of the predefined or user-defined combinations for releases is used for a rigid link start or end.</p> <p>These are the predefined options:</p>  <p>These options automatically set the degrees of freedom.</p> <p>You can modify a predefined combination to suit your needs. If you do that, Tekla Structures indicates it with this option:</p> 
<p>Ux Uy Uz</p>	<p>Define the translational degrees of freedom (displacements) in the global x, y, and z directions.</p> <p>The options are:</p> <ul style="list-style-type: none"> • Free • Fixed • Spring <p>If you select Spring, enter the translational spring constant. The units depend on the settings in File menu --> Settings --> Options --> Units and decimals.</p>
<p>Rx Ry Rz</p>	<p>Define the rotational degrees of freedom (rotations) in the global x, y, and z directions.</p> <p>The options are:</p> <ul style="list-style-type: none"> • Pinned • Fixed • Spring • Partial release <p>If you select Spring, enter the rotational spring constant. The units depend on the settings in</p>

Option	Description
	<p>File menu --> Settings --> Options --> Units and decimals.</p> <p>Use Partial release to specify if the degree of connectivity is between fixed and pinned. Enter a value between 0 (fixed) and 1 (pinned).</p>
Local Y direction	<p>Defines the local y direction of the rigid link. The options are the global x, y, and z directions.</p> <p>The local x direction is always the direction of the rigid link.</p>

See also

[Create a rigid link \(page 62\)](#)

[Analysis model objects \(page 9\)](#)

10.8 Analysis bar position properties

Use the **Analysis Bar Position Properties** dialog to view and modify the position of an analysis bar.

To access the dialog, select an analysis bar, and then double-click a handle at an end of the analysis bar.

Option	Description
Offset mode	Defines whether the automatic (Automatic offset) or user-defined (Manual offset) offset values are used for the analysis bar end.
Offset	Defines the offset values in the global x, y, and z directions.

See also

[Define the location of analysis parts \(page 75\)](#)

10.9 Analysis area position properties

Use the **Analysis Area Position Properties** dialog to view and modify the position of an analysis area.

To access the dialog, select an analysis area, and then double-click a handle at an analysis area corner.

Option	Description
Offset mode	Defines whether the automatic (Automatic offset) or user-defined (Manual offset) offset values are used for the analysis bar end.
Offset	Defines the offset values in the global x, y, and z directions.

See also

[Define the location of analysis parts \(page 75\)](#)

10.10 Analysis area edge properties

Use the **Analysis Area Edge Properties** dialog to view and modify the position and connectivity of an analysis area edge.

To access the dialog, select an analysis area, and then double-click a handle at the mid-point of an analysis area edge.

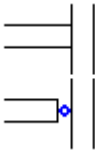
Option	Description
Offset mode	Defines whether the automatic (Automatic offset) or user-defined (Manual offset) offset values are used for the analysis bar end.
Offset	Defines the offset values in the global x, y, and z directions.
Releases	<p>Defines which of the predefined or user-defined combinations for releases is used for the analysis area edge.</p> <p>These are the predefined options:</p>  <p>These options automatically set the degrees of freedom.</p>

Option	Description
	<p>You can modify a predefined combination to suit your needs. If you do that, Tekla Structures indicates it with this option:</p> 
<p>Ux Uy Uz</p>	<p>Define the translational degrees of freedom (displacements) in the global x, y, and z directions.</p> <p>The options are:</p> <ul style="list-style-type: none"> • Free • Fixed • Spring <p>If you select Spring, enter the translational spring constant. The units depend on the settings in File menu --> Settings --> Options --> Units and decimals.</p>
<p>Rx Ry Rz</p>	<p>Define the rotational degrees of freedom (rotations) of a member end in the global x, y, and z directions.</p> <p>The options are:</p> <ul style="list-style-type: none"> • Pinned • Fixed • Spring • Partial release <p>If you select Spring, enter the rotational spring constant. The units depend on the settings in File menu --> Settings --> Options --> Units and decimals.</p> <p>Use Partial release to specify if the degree of connectivity is between fixed and pinned. Enter a value between 0 (fixed) and 1 (pinned).</p>

See also

[Define the location of analysis parts \(page 75\)](#)

11 Disclaimer

© 2026 Trimble Inc. and affiliates. All rights reserved.

Use of the Software and of this Software Manual are governed by a License Agreement which determines whether you are an authorized user of the Software and the Software Manual. The warranties and disclaimers set forth in the License Agreement apply to the Software and the Software Manual. Neither the Trimble entity granting the license nor any of its affiliates assume responsibility that the text is free of technical inaccuracies or typographical errors. The right to make changes and additions to this manual is reserved.

Trimble and certain product names are registered trademarks of Trimble Inc. in the United States, the European Union and other countries and may have similar statutory protections. Trademarks of third parties are not mentioned in this Manual to suggest an affiliation with or endorsement by their owners.

Elements of the software described in this Manual may be the subject of pending patent applications in the European Union and/or other countries.

Portions of this software:

Portions of this software make use of Open CASCADE Technology software. Open Cascade Express Mesh Copyright © 2019 OPEN CASCADE S.A.S. All rights reserved.

FLY SDK - CAD SDK © 2012 VisualIntegrity™. All rights reserved.

This application incorporates Open Design Alliance software pursuant to a license agreement with Open Design Alliance. Open Design Alliance Copyright © 2002–2020 by Open Design Alliance. All rights reserved.

CADhatch.com © 2017. All rights reserved.

RapidXml C++ library © All rights reserved.

FlexNet Publisher © 2016 Flexera Software LLC. All rights reserved. This product contains proprietary and confidential technology, information and creative works owned by Flexera Software LLC and its licensors, if any. Any use, copying, publication, distribution, display, modification, or transmission of such technology in whole or in part in any form or by any means without the prior express written permission of Flexera Software LLC is strictly prohibited. Except where expressly provided by Flexera Software LLC

in writing, possession of this technology shall not be construed to confer any license or rights under any Flexera Software LLC intellectual property rights, whether by estoppel, implication, or otherwise.

To see the third party open source software licenses, go to Tekla Structures, click **File menu** --> **Help** --> **About Tekla Structures** --> **3rd party licenses** and then click the option.

Index

A	
adding	
analysis model rules.....	57
objects to analysis model.....	60
analysis & design.....	7
analysis and design.....	7
settings.....	103
workflow.....	13
analysis and design applications.....	12
analysis and design models	
working with.....	86
analysis and design systems.....	12
analysis applications.....	12
linking to Tekla Structures.....	12
merging models.....	96
analysis areas	
edge properties.....	141
position properties.....	140
analysis axis	
location.....	76
of analysis models.....	54
of parts.....	75,76
options for parts.....	135
analysis bars.....	9
position properties.....	140
showing numbers.....	100
analysis class.....	100,132
analysis members.....	9
showing numbers.....	100
analysis model content	
changing.....	53
analysis model rules	
adding.....	57
creating.....	57
analysis models.....	7
adding objects.....	60
adding rules.....	57
axis settings.....	54
changing content.....	53
checking objects.....	52
content.....	48
copying.....	51
creating.....	47,49
creating by copying.....	51
creating modal models.....	50
creating rules.....	57
deleting.....	51
exporting.....	89
exporting to Tekla Structural Designer.....	89
filtering objects.....	48
importing from Tekla Structural Designer	
.....	92
including objects.....	47
merging.....	96
modifying.....	52
modifying properties.....	53
objects.....	9
properties.....	115
removing objects.....	60
resetting editing.....	78
resetting model merging.....	96
viewing results.....	101
warnings.....	86
working with.....	86
analysis nodes.....	9
appearance.....	61
colors.....	61
creating.....	61
merging.....	63
properties.....	137
showing numbers.....	100
analysis parts.....	9
axis location.....	75,76
copying.....	78
defining properties.....	65,66
deleting.....	79
modifying.....	65
modifying properties.....	65,66
moving.....	76
offsets.....	77
position.....	75

properties.....	122
resetting editing.....	78
viewing properties.....	66
analysis results	
saving.....	98
saving as user-defined attributes.....	99
viewing.....	99
analysis type.....	132
applying loads to parts.....	33
area loads.....	26
properties.....	107
attaching	
loads to parts.....	32
axis settings	
defining for analysis models.....	54
axis	
of analysis parts.....	76

B

bounding box.....	33
buckling length.....	73
Kmode options.....	74

C

check design.....	72
checking	
analysis models.....	52
load groups.....	42
loads.....	42
colors	
by analysis type.....	100,132
by analysis utility check.....	101
of analysis nodes.....	61
combining	
loads.....	80
compatibility of load groups.....	20
content	
of analysis model.....	48
copying	
analysis models.....	51
analysis parts.....	78
load combinations.....	83
creating	
analysis model rules.....	57
analysis models.....	47,49

analysis models by copying.....	51
analysis nodes.....	61
area loads.....	26
line loads.....	25
load combinations.....	81,82
load groups.....	15,18
loads.....	15,22
modal analysis models.....	50
point loads.....	25
rigid links.....	62
strain.....	27
temperature loads.....	27
uniform loads.....	26
wind loads.....	28

D

defining	
analysis part properties.....	65,66
design properties of analysis models...	56
design properties of analysis parts.....	71
load groups.....	18
modal masses for analysis models.....	55
seismic loads for analysis models.....	54
deleting	
analysis models.....	51
analysis parts.....	79
load combinations.....	85
load groups.....	21
design properties	
defining for analysis models.....	56
defining for analysis parts.....	71
design	
omitting parts.....	72
direct links.....	12
distances	
of loads.....	35
distributing loads.....	32

E

effective buckling length.....	73
Kmode options.....	74
end releases.....	68
examples	
creating wind loads.....	29
exporting	

analysis models.....	89	factors.....	113
analysis models to Tekla Structural Designer.....	89	properties.....	112
load groups.....	45	settings.....	112
		types.....	113
F		load combinations.....	80
filtering		copying.....	83
analysis model objects.....	48	creating.....	81,82
filters		deleting.....	85
in analysis models.....	48	modifying.....	83
		saving for later use.....	83
G		load forms.....	24
grouping		load groups.....	18
loads.....	15,18	checking.....	42
		compatibility.....	20
H		creating.....	15,18
handles		defining.....	18
of loads.....	40	deleting.....	21
		exporting.....	45
I		importing.....	46
importing		modifying.....	18
analysis models.....	92	moving loads to another group.....	44
from Tekla Structural Designer.....	92	properties.....	103
load groups.....	46	setting current.....	19
		working with.....	41
K		load modeling code.....	16
Kmode options.....	74	options.....	112
		load modeling	
L		non-standard combination factors.....	17
line loads.....	25	load panel.....	36,110
properties.....	106	load types.....	15
linking		load-bearing parts.....	33
Tekla Structures with analysis applications.....	12	loaded area.....	35
load attachment.....	32	loaded length.....	35
load combination process.....	80	loads	
using non-standard factors.....	17	applying.....	33
load combination		attaching.....	32
		bounding box.....	33
		changing length or area.....	35
		changing load group.....	44
		checking.....	42
		combining.....	80
		creating.....	15,22
		defining properties.....	22
		distribution.....	32
		forms.....	24
		grouping.....	15,18
		load panel properties.....	110
		magnitude.....	23

modal.....	55
modifying.....	32,35,40
modifying distribution.....	36
modifying location or layout.....	37
moving to another load group.....	44
properties.....	105
scaling in model views.....	41
seismic.....	54
types.....	15
working with.....	41

M

member axis location.....	54,135
merging	
analysis models.....	96
analysis nodes.....	63
models using analysis applications.....	96
models using SAP2000.....	96
resetting.....	96
modal analysis.....	55
creating analysis models.....	50
modal masses.....	55
model merging.....	96
resetting.....	96
modifying	
analysis model properties.....	53
analysis models.....	52
analysis part properties.....	65,66
analysis parts.....	65
load combinations.....	83
load groups.....	18
load location or layout.....	37
loads.....	32
moving	
analysis parts.....	76
load ends or corners.....	40

N

nodes, see analysis nodes.....	61
--------------------------------	----

O

offsets	
of analysis parts.....	77

P

partial safety factors.....	113
parts	
analysis properties.....	122
physical models.....	7
point loads.....	25
properties.....	105
position	
of analysis parts.....	75
properties	
analysis models.....	115
analysis parts.....	122
load combination.....	112
loads.....	105

R

reduction factors.....	113
removing	
objects from analysis model.....	60
reports	
of loads.....	42
resetting	
editing of analysis parts.....	78
rigid diaphragms.....	9
rigid links.....	9
creating.....	62
properties.....	138

S

SAP2000	
merging analysis models.....	96
saving	
analysis results.....	98
analysis results as user-defined	
attributes.....	99
load combinations.....	83
scaling	
loads in model views.....	41
seismic analysis.....	54
seismic loads.....	54
seismic masses.....	54
setting	
current load group.....	19
load modeling code.....	16

settings	
analysis and design properties.....	103
analysis area edge properties.....	141
analysis area position properties.....	140
analysis bar position properties.....	140
analysis model properties.....	115
analysis node properties.....	137
analysis part properties.....	122
area load properties.....	107
line load properties.....	106
load combination properties.....	112
load group properties.....	103
load panel properties.....	110
load properties.....	105
point load properties.....	105
rigid link properties.....	138
temperature load properties.....	108
uniform load properties.....	107
wind load properties.....	109
showing	
analysis bar numbers.....	100
analysis member numbers.....	100
analysis node numbers.....	100
strain.....	27
support conditions.....	68
defining for part ends.....	68
defining for plates.....	69
symbols.....	70

T

Tekla Structural Designer	
exporting to.....	89
importing from.....	92
temperature loads.....	27
properties.....	108

U

uniform loads.....	26
properties.....	107
utilization ratio.....	101

V

viewing	
---------	--

analysis results.....	99
-----------------------	----

W

warnings	
about analysis models.....	86
Wind Load Generator (28).....	28,29
properties.....	109
wind loads	
creating.....	28
examples.....	29
properties.....	109
workflow	
in analysis and design.....	13

